

QUANTUM[®] STORAGE SYSTEMS

*The most efficient, permanent, and economical solution
to solve your exact storage needs!*

Distributed by:

CLASS C COMPONENTS

6825 SUNWOOD DRIVE N.W. RAMSEY, MN 55303
PH 763-535-0400 FAX 763-535-1400



ISO 9001 Certified Company
www.classccomponents.com
Quality • Service • Versatility



**THE LARGEST SELECTION OF PLASTIC BINS,
STEEL & WIRE SHELVING AND COMPLETE BIN SYSTEMS**

TABLE OF CONTENTS

ULTRA BINS & SYSTEMS

- 4 Ultra Stack and Hang Bins
- 5 Ultra Stack and Hang Bins
- 6 Mesh Stack and Hang Bins **NEW**
- 7 Wire Louvered Panels **NEW**
- 8 Louvered Panels
- 9 Louvered Panels & Racks
- 10 Q-Peg Wall Systems
- 11 Q-Peg Wall Systems
- 12 Louvered Racks
- 13 Hanging Rail Systems
- 14 Complete Package Systems
- 15 Giant Open Hopper Steel Shelving Systems
- 16 Giant Open Hopper Wire Shelving Systems
- 17 Heavy-Duty 36" All-Welded Bin Cabinets
- 18 Heavy-Duty 36" & 48" Specialty Bin Cabinets
- 19 Heavy-Duty 48" All-Welded Bin Cabinets
- 20 Heavy-Duty 60" & 72" All-Welded Bin Cabinets
- 21 Heavy-Duty 48" Cabinet, 60" Work Bench & Rail Carts

CLEAR-VIEW BINS

- 22 Ultra Bins and Shelving Systems
- 23 Ultra Bin Systems
- 24 HULK 24" Containers and Shelving Systems
- 25 Giant Stack Containers and Shelving Systems
- 26 Economy 4" Shelf Bins and Shelving Systems
- 27 Economy 4" Shelf Bin Shelving Systems
- 28 Store-More 6" Shelf Bins and Shelving Systems
- 29 Store-More 6" Shelf Bin Shelving Systems
- 30 Store-Max 8" Shelf Bins **NEW**
- 31 Store-Max 8" Shelf Bin Shelving Systems **NEW**
- 32 Dividable Grid Containers and Shelving Systems

BINS, TOTES & CONTAINERS

- 33 Labels
- 34 Stackable Shelf Bins **NEW**
- 35 Stackable Shelf Bin Shelving Systems **NEW**
- 36 HULK 24" Containers
- 37 HULK 24" Container Steel Shelving Systems
- 38 HULK 24" Container Wire Shelving Systems
- 39 HULK 30" & 36" Containers
- 40 HULK 30" Container Wire Shelving Systems
- 41 HULK 36" Container Wire Shelving Systems
- 42 Rackbin 42" Containers
- 43 Rackbin 42" Container Wire Shelving Systems
- 44 Giant Stack Containers
- 45 Giant Stack Container Storage Center
- 46 Giant Stack Container Wire Shelving Systems
- 47 MAGNUM Bins
- 48 MAGNUM Bin Steel Shelving Systems
- 49 MAGNUM Bin Wire Shelving Systems
- 50 Economy 4" Shelf Bins
- 51 Economy 4" Shelf Bin Steel Shelving Systems
- 52 Economy 4" Shelf Bin Sloped Shelving Systems
- 53 Economy 4" Shelf Bin Wire Shelving Systems
- 54 High Density Wire Shelving Systems
- 55 Store-More 6" Shelf Bins
- 56 Store-More 6" Shelf Bin Steel Shelving Systems
- 57 Store-More 6" Shelf Bin Sloped Shelving Systems
- 58 Store-More 6" Shelf Bin Wire Shelving Systems

- 59 Store-Max 8" Shelf Bins **NEW**
- 60 Store-Max 8" Shelf Bin Steel Shelving Systems **NEW**
- 61 Store-Max 8" Shelf Bin Wire Shelving Systems **NEW**
- 62 Super Tuff Euro Drawers
- 63 Super Tuff Euro Drawer Steel Shelving Systems
- 64 Super Tuff Euro Drawer Sloped Shelving Systems
- 65 High Performance Stack and Lock Bins
- 66 QuickPick Bins and Wire Shelving Systems
- 67 Dividable Grid Containers
- 68 Genuine stack and nest totes
- 69 Wire Shelving Systems
- 70 Cross Stack Tubs and Quantub
- 71 Tub Racks
- 72 Stacker Straight Wall & Collapsible Containers
- 73 Attached Top Distribution Containers
- 74 Collapsible Bulk Box
- 75 Removable Tray Trucks
- 76 Bin Transport & Sloped Shelf Trucks
- 77 Polymer Utility Carts & Tool Caddy

SPECIALTY

- 78 Recycled Bins
- 79 Organizers / Computer Work Center
- 80 Conductive Bins, Hanging Systems & Racks
- 81 Conductive Hanging Systems & Racks
- 82 Conductive Shelf Bins and Wire Shelving Systems
- 83 Conductive Dividable Grid Containers and Bin Carts
- 84 Conductive Wire Utility Carts, Trays and Tray Carts
- 85 Custom Protection & Internal Dunnage **NEW**
- 86 Clear Tip Out Bins
- 87 Dividable and Individual Clear Tip Out Bins
- 88 Clear Tip Out Bin Floor Stands
- 89 Mobile Clear Tip Out Bin Floor Stands
- 90 Clear Tip Out Bin Rails and Frames
- 91 Free Standing & Gondola Slider Systems
- 92 Interlocking Storage Cabinets
- 93 Interlocking Storage Cabinet Floor Stands

STEEL

- 94 IRONMAN 18 & 20 Gauge Steel Open Shelving - Starter Kits
- 95 IRONMAN 18 & 20 Gauge Steel Open Shelving - Starter Kits
- 96 IRONMAN 18 & 20 Gauge Steel Open Shelving - Add-On Kits
- 97 IRONMAN 18 & 20 Gauge Steel Open Shelving - Add-On Kits
- 98 IRONMAN 18 & 20 Gauge Steel Closed Shelving - Starter Kits
- 99 IRONMAN 18 & 20 Gauge Steel Closed Shelving - Starter Kits
- 100 IRONMAN 18 & 20 Gauge Steel Closed Shelving - Add-On Kits
- 101 IRONMAN 18 & 20 Gauge Steel Closed Shelving - Add-On Kits
- 102 IRONMAN 22 Gauge Steel Shelving

WIRE

- 103 Wire Shelving System Finishes
- 104 Wire Shelves
- 105 Posts / Solid Shelves
- 106 54" Wire Shelving Units
- 107 63" Wire Shelving Units
- 108 74" Wire Shelving Units
- 109 86" Wire Shelving Units
- 110 Galvanized Steel Solid Shelving Units

- 111 Galvanized Steel Solid Shelving Units
- 112 Stainless Steel Solid Shelving Units
- 113 Stainless Steel Solid Shelving Units
- 114 Convenient 1 Box Wire Shelving Units **NEW**
- 115 Grid-Store Wall Mounted Systems
- 116 PARTition Wall Systems
- 117 PARTition Wall Systems
- 118 PARTition Wall Systems **NEW**
- 119 PARTition Wall Systems - Accessories
- 120 Wall Mount Cantilever Systems
- 121 Wall Mount Cantilever Systems
- 122 Modular Wire Stacking Baskets
- 123 Wire Basket Units
- 124 Post Baskets & Mobile Units **NEW**
- 125 Labels
- 126 PARTition Store Pull Out Basket Carts **NEW**
- 127 PARTition Store Pull Out Basket Carts **NEW**
- 128 PARTition Store Single Bay Carts **NEW**
- 129 PARTition Store Double Bay Carts **NEW**
- 130 PARTition Store - Accessories
- 131 Shelves & Frames
- 132 Dunnage & Platform Racks **NEW**
- 133 Dunnage & Platform Racks **NEW**
- 134 Slanted Shelf Carts
- 135 Slanted Shelf Carts
- 136 Bin Carts
- 137 Double & Triple Bay Bin Carts
- 138 Utility Carts
- 139 Modular Trays and Tray Carts
- 140 Cart Covers
- 141 Stem Caster Carts
- 142 Enclosure Carts
- 143 Enclosure Carts
- 144 Enclosure Carts
- 145 Security Units
- 146 High Density Sliding Floor Track System
- 147 High Density Sliding Floor Track System
- 148 High Density Sliding Overhead Track System **NEW**
- 149 High Density Sliding Overhead Track System **NEW**
- 150 Wire Shelving - Accessories
- 151 Wire Shelving - Accessories
- 152 Wire Shelving - Accessories
- 153 Wire Shelving - Accessories

MEDICAL

- 154 Hamper and Sterile Wrap Carts
- 155 Stainless Steel Carts & Tables
- 156 Catheter Carts
- 157 Garment Racks / Patient Apparel Cart
- 158 Bin Transport Carts
- 159 Layout & Design Services

ULTRA BINS & SYSTEMS



Ultra Stack & Hang Bins
4-5



Mesh Stack & Hang Bins
6



Wire Louvered Panels
7



Louvered Panels & Bench Racks
8-9



Q-Peg Wall Systems
10-11



Louvered Racks, Rails & Complete Systems
12-14



Giant Open Hopper Steel Shelving Systems
15

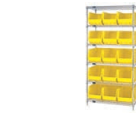

Giant Open Hopper Wire Shelving Systems
16



Cabinets, Work Bench & Rail Carts
17-21

CLEAR-VIEW BINS



Ultra Bins & Shelving Systems
22



Ultra Bin Systems
23



Hulk 24" Containers & Shelving Systems
24



Giant Stack Containers & Shelving Systems
25



Economy 4" Shelf Bins & Shelving Systems
26-27



Store-More 6" Shelf Bins & Shelving Systems
28-29



Store-Max 8" Shelf Bins
30



STORE-MAX Shelf Bin Shelving Systems
31



Dividable Grid Containers & Systems
32

BINS, TOTES & CONTAINERS



Stackable Shelf Bins & Shelving Systems
34-35



Hulk 24" Containers & Shelving Systems
36-38



Hulk 30" & 36" Containers & Shelving Systems
39-41



RackBin 42" Containers & Shelving Systems
42-43



Giant Stack Containers & Shelving Systems
44-46



Magnum Bins & Shelving Systems
47-49



Economy 4" Shelf Bins & Shelving Systems
50-54



Store-More 6" Shelf Bins & Shelving Systems
55-58



Store-Max 8" Shelf Bins & Shelving Systems
59-61



Super Tuff Euro Drawers & Shelving Systems
62-64



Dividable Grid Containers
67



Genuine Stack and Nest Totes
68



Cross Stack Tubs, QuanTub and Racks
70-71



Stacker Straight Wall & Collapsible Containers
72



Attached Top Distribution Containers
73



Collapsible Bulk Box
74



Removable Tray & Bin Transport Trucks
75-76



Polymer Utility Carts & Tool Caddy
77

SPECIALTY



Recycled Bins
78



Organizers / Computer Work Center
79



Conductive Bins, Systems & Racks
80-81



Conductive Shelf Bins & Wire Shelving Systems
82



Conductive Grid Containers & Bin Carts
83



Conductive Wire Utility Carts, Trays & Tray Carts
84



Clear Tip Out Bins
86-87



Clear Tip Out Bin Systems
88-91



Interlocking Storage Cabinets & Floor Stands
92-93

STEEL



39" Steel Open Shelving - Starter Kits
94



75", 87" & 99" Steel Open Shelving - Starter Kits
95



39" Steel Open Shelving - Add-On Kits
96



75", 87" & 99" Steel Open Shelving - Add-On Kits
97



39" Steel Closed Shelving - Starter Kits
98



75", 87" & 99" Steel Closed Shelving - Starter Kits
99



39" Steel Closed Shelving - Add-On Kits
100



75", 87" & 99" Steel Closed Shelving - Add-On Kits
101



Ironman 22 Gauge Steel Shelving
102

WIRE



Wire & Solid Shelves and Posts
103-105



Wire & Solid Shelving Units
106-114



Grid-Store Wall Mounted Systems
115



PARTition Wall Systems
116-119



Wall Mount Systems
120-121



Wire Basket Units
122-123



Post Baskets & Mobile Units
124



PARTition Store Carts
126-130



Shelves, Frames & Platform Racks
131-133



Slanted Shelf & Bin Carts
134-137



Utility Carts
138



Modular Trays & Tray Carts
139



Cart Covers & Carts
140-145



Sliding Track Systems
146-149



Wire Shelving Accessories
150-153



Hamper & Sterile Wrap Carts
154



Catheter Carts
156



Garment Bins & Patient Apparel Cart
157

MEDICAL

Ultra Stack and Hang Bins

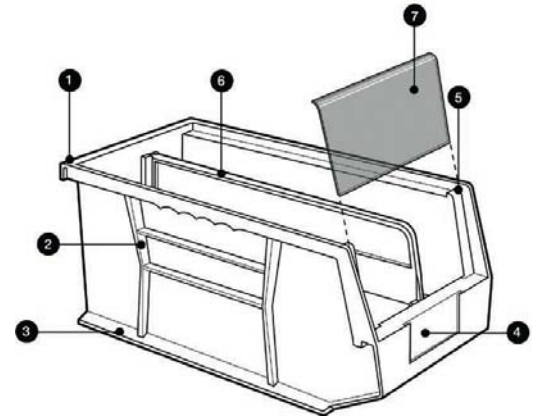

PERFORMANCE FEATURES:

- Available in 19 sizes
- Standard colors: Blue, Green, Ivory, Red, Yellow, Black and Clear
Pink color is available in select sizes
(additional colors available on request, subject to up charge and minimum runs)
- Bins are made from heavy-duty, virgin, high density FDA approved polypropylene
- Large label slot provide easy label insertion and parts identification
- Extra wide stacking ledge assures stability for high stacking
- Reinforced design adds strength and prevents spreading
- Will not rust or corrode, unaffected by weak acids and alkalis, and are waterproof
- Autoclavable up to 250°F
- Interchangeable with other manufactured brands of bins

- 1 Full width hanger supports bin when hanging from louvered panels or rails
- 2 Reinforced rib design adds strength and prevents spreading
- 3 Extra-wide stacking ledge for secure stacking
- 4 Large front label slot allows larger bar code scanning and content identification
- 5 Anti-slide stop prevents stacked bins from shifting forward
- 6 Optional dividers increase storage options
- 7 Optional windows maximize storage capacity, prevent spillage and protect parts from dust and dirt



NEW
Shown with optional clear lid
Lid pivots up and down via insertion
in holes in rear of bin
(Sold separately)



Shown with optional
window front and divider
(Sold separately)



CLEAR LABEL HOLDER
Clear label holders and laser
label inserts slide into front
label slot of all bins.
Package of 25.



MOBILE ULTRA BIN
Ideal for transport of heavy
and bulky parts
Bin comes with 4 swivel,
3" casters, all with brakes,
allowing up to 250 lb.
mobile load capacity



POLYMER MOBILE DOLLY
DLY-3018 Dolly with Padded Rubber Trim,
available in Blue. 1,000 lb. capacity.
Dimensions 30"L x 18"W
(Bin sold separately)



ATTACHED PULL RING
Allows dolly to be pulled
with ease



32" Dolly Pull Rod with handle

MODEL NO.	DESCRIPTION	CTN WGT
DLY-3018	Dolly with Padded Rubber Trim	19 lbs
HANDLE-DLY	32" Dolly Pull Rod with Handle	2 lbs

Bins sold separately.



LOWEST PRICE GUARANTEED!

19 SIZES AND 8 COLORS AVAILABLE THE LARGEST SELECTION ANYWHERE

CLEAR BIN
VIEW

AVAILABLE on pg. 22



NEW

Pink color in select sizes

HEAVY-DUTY LIFETIME USE

Bin Dimensions Guide
L (length) W (width)
H (height) X (inside length)

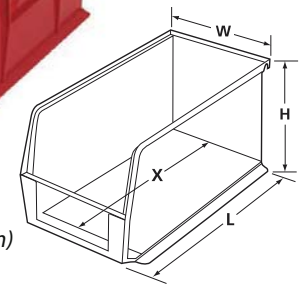

Ultra Stack and Hang Bins



Organize your inventory with these strong bins, manufactured of FDA approved materials. Front, back and side grips for easy handling. Built-in rear hanger allows bins to hang from louvered panels or rails. Optional clear injection molded crystal styrene window front increases bin capacity and provides quick view of bin contents. Dividers maximize flexibility and keep contents organized. Wide stacking ledge and anti-slide lock keep stacked bins steady and prevent forward shifting. Water, rust, and corrosion proof. Easily cleaned with soap and water and impervious to most chemicals. Large molded front label slots for ID labels. Autoclavable up to 250°F and resistant to extreme cold. Guaranteed not to break or crack under normal load conditions. Available in 8 colors. See pg. 22 to order Clear Bins.

Available in: ● Blue ● Green ● Ivory ● Red ● Yellow ● Black ● Clear QUS210, QUS230, QUS240, QUS250 also available in: ● Pink

NEW

MODEL NO.	OUTSIDE DIMENSIONS L" x W" x H"	INSIDE DIMENSIONS L" x W" x H"	CTN QTY	CTN WGT	BIN LOAD CAPACITY*	CLEAR WINDOW	CTN QTY	CTN DIVIDER	CTN DIVIDER SLOTS	CLEAR LABEL HOLDER & INSERT	CLEAR LID	CTN QTY
QUS200	5" x 4-1/8" x 3"	4-3/8" x 3-7/16" x 2-13/16"	24	5 lbs	8 lbs	-	-	DUS200	6	1	LTR-1300	-
QUS210	5-3/8" x 4-1/8" x 3"	4-3/4" x 3-7/16" x 2-13/16"	24	6 lbs	10 lbs	-	-	DUS210	6	1	LTR-1300	COV210
QUS220	7-3/8" x 4-1/8" x 3"	6-3/4" x 3-7/16" x 2-13/16"	24	8 lbs	10 lbs	-	-	DUS220	6	1	LTR-1300	COV220
QUS221	9-1/4" x 6" x 5"	8-1/2" x 5-1/8" x 4-1/2"	12	6 lbs	20 lbs	WUS221	12	DUS221	6	1	LTR-1754	-
QUS224	10-7/8" x 4-1/8" x 4"	10-1/4" x 3-3/16" x 3-3/4"	12	8 lbs	30 lbs	WUS224	12	DUS224	6	1	LTR-1253	COV224
QUS230	10-7/8" x 5-1/2" x 5"	10-1/4" x 4-3/8" x 4-3/4"	12	10 lbs	30 lbs	WUS230/234	12	DUS230/235	6	1	LTR-1754	COV230
QUS234	14-3/4" x 5-1/2" x 5"	14-1/16" x 4-3/8" x 4-3/4"	12	14 lbs	50 lbs	WUS230/234	12	DUS234	6	1	LTR-1754	-
QUS235	10-7/8" x 11" x 5"	10-1/4" x 10" x 4-3/4"	6	10 lbs	50 lbs	WUS235	6	DUS230/235	6	3	LTR-1754	COV235
QUS239	10-3/4" x 8-1/4" x 7"	10" x 6-9/16" x 6-3/4"	6	10 lbs	50 lbs	WUS239/240	6	DUS239	6	1	LTR-1754	COV239
QUS240	14-3/4" x 8-1/4" x 7"	14" x 6-9/16" x 6-3/4"	12	24 lbs	60 lbs	WUS239/240	6	DUS240/250	6	1	LTR-1754	COV240
QUS241	13-5/8" x 8-1/4" x 6"	12-1/2" x 6-3/4" x 5-3/8"	12	22 lbs	60 lbs	WUS241	12	DUS241	6	1	LTR-1754	-
QUS242	13-5/8" x 8-1/4" x 8"	12-1/2" x 6-3/4" x 7-3/8"	12	25 lbs	60 lbs	WUS242	12	DUS242	6	1	LTR-1754	-
QUS245	10-7/8" x 16-1/2" x 5"	9-3/4" x 15" x 4-3/4"	6	13 lbs	60 lbs	WUS245	6	DUS245	6	3	LTR-1754	-
QUS250	14-3/4" x 16-1/2" x 7"	14" x 14-3/4" x 6-3/4"	6	21 lbs	75 lbs	WUS250	6	DUS240/250	6	3	LTR-1754	-
QUS255	16" x 11" x 8"	15-1/8" x 10" x 7-3/4"	4	14 lbs	75 lbs	WUS255	4	DUS255	6	3	LTR-1754	-
QUS260	18" x 11" x 10"	17" x 9-1/2" x 9-3/4"	4	17 lbs	75 lbs	WUS260	4	DUS260	6	3	LTR-1754	-
QUS265	18" x 8-1/4" x 9"	17-1/8" x 6-3/4" x 8-1/4"	6	17 lbs	60 lbs	WUS265	6	DUS265	6	1	LTR-1754	-
QUS270	18" x 16-1/2" x 11"	17-1/8" x 14-3/4" x 10-1/4"	3	16 lbs	75 lbs	WUS270	3	DUS270	6	3	LTR-2400	-
QUS275MOB	18" x 16-1/2" x 11"***	17-1/8" x 14-3/4" x 10-1/4"	3	25 lbs	-	WUS270	3	DUS270	6	3	LTR-2400	-

* When attached to panels or rails ** With casters, overall height is 14" Individual labels are available for all Ultra Bins. For label Model No., substitute "L" for "Q" in bin Model No. (Ex.: Label for QUS230 is LUS230) Ctn Qty: 50 Individual Labels

9 SIZES AVAILABLE



Exclusive! Mesh Stack and Hang Bins



New patented Wire Mesh Bins are an industry exclusive. Our innovative mesh design offers a nickel-chrome finish and a 3/8" x 3/8" grid pattern allowing complete visibility of the bin's contents. This unique mesh pattern provides a dust and dirt free storage environment. Ultra strong design allows for superior hang capacity perfect for industrial parts storage or anything where hang capacities are vital. Available in 9 popular sizes, Quantum's Mesh Bins feature a rear hanger that allows them to hang from any louvered wall panel or rail system and optional side hanger which allows bin to stack one on top of the other. The open hopper design allows for easy picking while allowing visual access to stored contents. Two optional label holders are available for all Mesh Bins. **Finish:** Chrome



REAR HANGER
All mesh bins have a super strong rear hanger that allows hanging from a louvered panel or rail system

STACKING MESH BINS
Shown with optional Hanging Label Tag & Side Hanger
Mesh bins can easily stack one on top of another with optional hangers (Sold separately)

MODEL NO.	OUTSIDE DIMENSIONS L" x W" x H"	INSIDE DIMENSIONS L" x W" x H"	CTN QTY	CTN WGT	SIDE HANGER SOLD PER PAIR	DIVIDER
QMB510C	5-1/4" x 4-1/4" x 3"	4-3/4" x 4" x 2-7/8"	20	12 lbs	HMB510C	DMB510C
QMB520C	7-1/4" x 4-1/4" x 3"	6-3/4" x 4" x 2-7/8"	20	15 lbs	HMB520C	DMB520C
QMB530C	10-3/4" x 5-1/2" x 5"	10-1/4" x 5-1/2" x 4-3/4"	10	12 lbs	HMB530/535C	DMB530/535C
QMB535C	10-3/4" x 11" x 5"	10-1/4" x 10-3/4" x 4-3/4"	10	19 lbs	HMB530/535C	DMB530/535C
QMB539C	10-1/2" x 8" x 7"	10" x 7-1/2" x 6-3/4"	10	20 lbs	HMB539C	DMB539C
QMB540C	14-1/2" x 8" x 7"	14" x 7-2/5" x 6-3/4"	10	30 lbs	HMB540/550C	DMB540/550C
QMB550C	14-1/2" x 16-1/4" x 7"	14" x 15-3/4" x 6-3/4"	5	17 lbs	HMB540/550C	DMB540/550C
QMB560C	18-1/2" x 11" x 10-1/8"	18-1/16" x 10-5/8" x 10"	5	21 lbs	HMB560/570C	DMB560/570C
QMB570C	18-1/2" x 17-1/8" x 11-1/8"	18-1/8" x 16-5/8" x 11"	5	28 lbs	HMB560/570C	DMB560/570C



Shown with optional **Divider**
(Sold separately)



Shown with optional **Side Stacking Hangers**
(Sold separately)

Accessories

**INSTANT VISIBILITY
NO DUST OR DIRT
BUILDUP
ALL WELDED**



Shown with optional **HBL3C Clear Label Holder**
Fits 1-1/8" x 3" Label
(Sold separately)

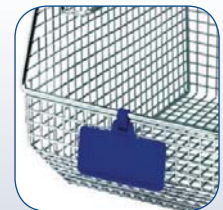

Shown with optional **PS-LH3 Hanging Label Tag**
Fits 1-3/8" x 3" Adhesive Label
Clear, Red, Yellow, Blue & Green
(Sold separately)



LOWEST PRICE GUARANTEED!



WLP-1836C
36" L x 18" H
Accepts all sizes of Ultra Stack & Hang Bins and Mesh Bins. Includes 8 direct mount clips. 175 lb. load capacity.

NEW

Exclusive! Wire Louvered Panels



Quantum's new chrome wire louvered panels offer a perfect mounting solution for all plastic hanging and new wire mesh hanging bins. Quantum's exclusive offering of wire panels, available in three sizes, completely resist any buildup of dust or dirt. Included direct mounting clips enable fastening to any surface (wall, wood, concrete, drywall, etc.) a snap (note: mounting screws are not included as they differ based on what type of surface the panels are being mounted to). Offset mounting clips are also available, can be used in place of WLP-DMC if you want to have wire panel mounted offset (away) from a wall surface making it easier to clean behind the panel (sold separately). Manufactured of heavy-duty chrome wire, Quantum's wire panels will offer years of dependable and heavy-duty service.



WLP-3036C
36" L x 30" H
Accepts all sizes of Ultra Stack & Hang Bins and Mesh Bins. Includes 12 direct mount clips. 175 lb. load capacity.

MODEL NO.	DIMENSIONS L" x H"	CTN QTY	CTN WGT
Wire Wall Mounted Louvered Panels			
WLP-1836C	36" x 18" Wire Louvered Panel	1	12 lbs
WLP-3036C	36" x 30" Wire Louvered Panel	1	19 lbs
WLP-3048C	48" x 30" Wire Louvered Panel	1	26 lbs

Accessories



WLP-DMC
Direct Mount Clips - 4 pack
(Included with wire louvered panels)
Extra packages available (if needed). (Sold separately)



WLP-OSC
Offset Mount Clips - 4 pack
Offsets panel from wall surface allowing one to clean behind panel
(Sold separately)

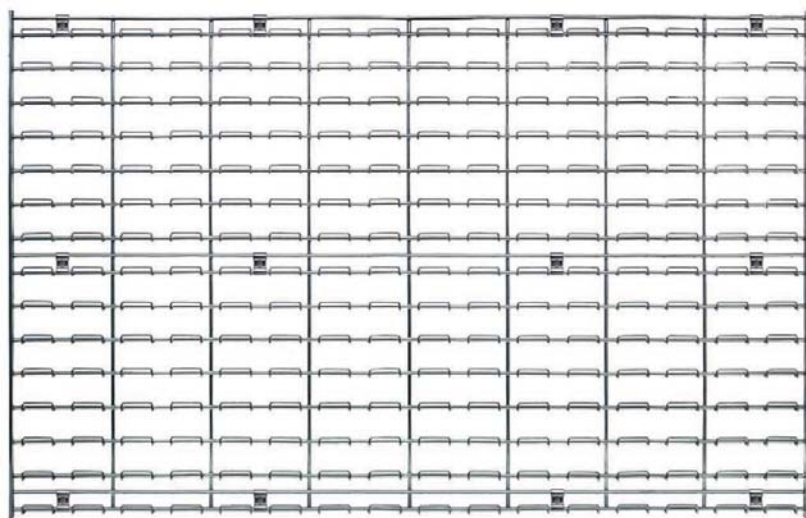

WLP-3048C
48" L x 30" H
Accepts all sizes of Ultra Stack & Hang Bins and Mesh Bins. Includes 12 direct mount clips. 250 lb. load capacity.

SIMPLE TO MOUNT
EASY TO CLEAN
ALL WELDED

MODEL NO.	QUANTITY OF MESH BINS TO FIT LOUVERED PANELS									QUANTITY OF ULTRA BINS TO FIT LOUVERED PANELS																	
	QMB 510	QMB 520	QMB 530	QMB 535	QMB 539	QMB 540	QMB 550	QMB 560	QMB 570	QUS 200	QUS 210	QUS 220	QUS 221	QUS 224	QUS 230	QUS 234	QUS 235	QUS 239	QUS 240	QUS 241	QUS 242	QUS 245	QUS 250	QUS 255	QUS 260	QUS 265	QUS 270
WLP-1836C	32	32	18	9	8	8	4	3	2	32	32	32	18	18	18	18	9	8	8	8	8	6	4	6	3	4	2
WLP-3036C	56	56	30	15	16	16	6	6	6	56	56	56	30	30	30	30	15	16	16	16	16	10	6	9	6	8	6
WLP-3048C	77	77	40	20	20	20	8	12	6	77	77	77	40	40	40	40	20	20	20	20	20	10	8	12	12	15	6

See pg. 5 & 6 for bin dimensions.

Ultra Hanging Louvered Panels

Quantum Ultra bins will hang on louvered panels in a wide range of configurations designed to meet all application needs. Use the system best suited to your needs with your choice of Ultra Bins. Systems are formed from heavy-duty 16 gauge cold rolled steel and have a Gray or Oyster White powder coat finish which ensures years of heavy-duty use. Louvered panels may be mounted on any suitable wall surface. Fasten securely to assure adequate load bearing.

MODEL NO.	DIMENSIONS L" x H"	CTN QTY	CTN WGT
Gray Wall Mounted Louvered Panels			
QLP-1819	18" x 19" Gray Louvered Panel	1	6 lbs
QLP-1861	18" x 61" Gray Louvered Panel	1	21 lbs
QLP-2721	27" x 21" Gray Louvered Panel	1	11 lbs
QLP-3612	36" x 12" Gray Louvered Panel	1	8 lbs
QLP-3619	36" x 19" Gray Louvered Panel	1	13 lbs
QLP-3661	36" x 61" Gray Louvered Panel	1	40 lbs
QLP-4819	48" x 19" Gray Louvered Panel	1	18 lbs
QLP-4861	48" x 61" Gray Louvered Panel	1	60 lbs
Oyster White Wall Mounted Louvered Panels			
QLP-1819HC	18" x 19" Oyster White Louvered Panel	1	6 lbs
QLP-1861HC	18" x 61" Oyster White Louvered Panel	1	21 lbs
QLP-3619HC	36" x 19" Oyster White Louvered Panel	1	13 lbs
QLP-3661HC	36" x 61" Oyster White Louvered Panel	1	40 lbs
QLP-4861HC	48" x 61" Oyster White Louvered Panel	1	60 lbs



QLP-1819
18"L x 19"H
Accepts all sizes of Ultra Bins.
175 lb. load capacity.
(Bins sold separately)

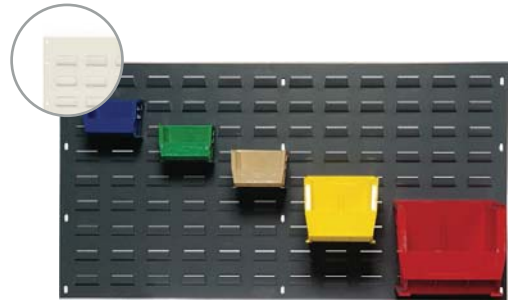

QLP-3619
36"L x 19"H
Accepts all sizes of Ultra Bins.
175 lb. load capacity.
(Bins sold separately)

GRAY OR OYSTER WHITE COLOR



QLP-3612
36"L x 12"H
Accepts all sizes of Ultra Bins.
175 lb. load capacity.
(Bins sold separately)



QLP-4819
48"L x 19"H
Accepts all sizes of Ultra Bins.
250 lb. load capacity.
(Bins sold separately)



QLP-1861
18"L x 61"H
Accepts all sizes of Ultra Bins.
500 lb. load capacity.
(Bins sold separately)



QLP-3661
36"L x 61"H
Accepts all sizes of Ultra Bins.
1,000 lb. load capacity.
(Bins sold separately)



QLP-2721
27"L x 21"H
Accepts all sizes of Ultra Bins.
175 lb. load capacity.
(Bins sold separately)



LOWEST PRICE GUARANTEED!

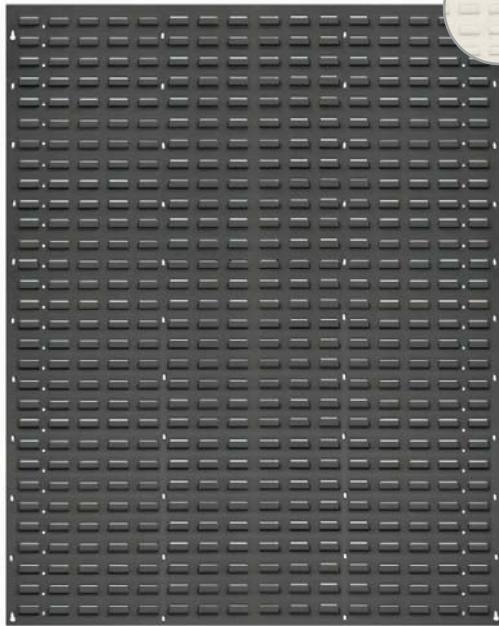

QLP-4861

48" L x 61" H
Accepts all sizes of Ultra Bins.
1,000 lb. load capacity.



QBR-3619

36" L X 8" W x 19" H
Accepts all sizes of Ultra Bins.
150 lb. load capacity.
(Bins sold separately)



QBR-3612

36" L X 8" W x 12" H
Accepts all sizes of Ultra Bins.
125 lb. load capacity.
(Bins sold separately)



QBR-1819

18" L X 8" W x 19" H
Accepts all sizes of Ultra Bins.
140 lb. load capacity.
(Bins sold separately)

Accessories

NEW



WS-SR9C
9" Single Rod
15 lb. load capacity

NEW



WS-HDS6
Heavy-Duty 6" Spike
65 lb. load capacity

NEW

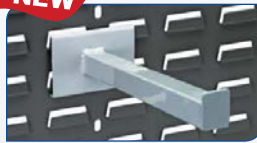

WS-HDS12
Heavy-Duty 12" Spike
50 lb. load capacity

NEW



WS-DR10C
10" Double Rod
15 lb. load capacity

NEW



SLP-1236 and SLP-1836
Flat Shelf with 2 Brackets
75 lb. load capacity

NEW



WS-VTH
Vertical Tape/Reel Holder
25 lb. load capacity

NEW

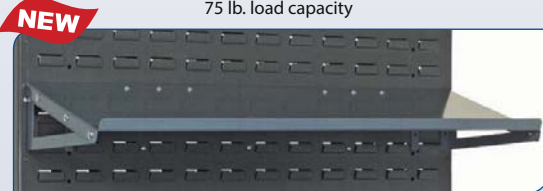

SLP-A1236 and SLP-A1836
Slanted Shelf with 2 Slanted Brackets
75 lb. load capacity

NEW



WS-HTH
Horizontal Tape/Reel Holder
25 lb. load capacity

CUSTOMIZE YOUR OWN UNIT

1. Select the hanging unit of your choice.
2. Turn to **pg. 5** and choose the bin that best fits your need.
3. Go to the chart at the bottom of this page and determine how many bins fit on the unit you selected.
4. Place your order for both unit and bins.

MODEL NO.	DIMENSIONS L" x W" x H"	CTN QTY	CTN WGT
QBR-1819	18" x 8" x 19" Bench Rack	1	11 lbs
QBR-2721	27" x 8" x 21" Bench Rack	1	15 lbs
QBR-3612	36" x 8" x 12" Bench Rack	1	12 lbs
QBR-3619	36" x 8" x 19" Bench Rack	1	17 lbs

QUANTITY OF ULTRA BINS TO FIT LOUVERED PANELS

MODEL NO.	QUS 200	QUS 210	QUS 220	QUS 221	QUS 224	QUS 230	QUS 234	QUS 235	QUS 239	QUS 240	QUS 241	QUS 242	QUS 245	QUS 250	QUS 255	QUS 260	QUS 265	QUS 270
QLP-1819	16	16	16	9	12	9	9	3	4	4	4	4	3	2	1	1	4	1
QLP-1861	60	60	60	30	30	30	30	15	14	14	14	14	10	7	7	5	12	5
QLP-2721	30	30	30	12	12	12	12	6	6	6	6	6	3	2	4	4	6	1
QLP-3612	18	18	18	12	12	12	12	6	4	4	4	4	4	2	6	3	8	2
QLP-3619	40	40	40	18	24	18	18	9	8	8	8	8	6	4	6	3	8	2
QLP-3661	120	120	120	60	80	60	60	30	28	28	28	28	20	14	21	15	24	10
QLP-4819	55	55	55	24	24	24	24	12	10	10	10	10	6	4	8	8	10	2
QLP-4861	165	165	165	80	80	80	80	40	35	35	35	35	20	14	28	20	30	10
QBR-1819	16	16	9	12	9	9	9	3	4	4	4	4	3	2	1	1	4	1
QBR-2721	30	30	12	12	12	12	12	6	6	6	6	6	3	2	4	4	6	1
QBR-3612	18	18	12	12	12	12	12	6	4	4	4	4	4	2	6	3	8	2
QBR-3619	32	32	18	32	18	18	18	9	8	8	8	8	6	4	6	3	8	2

See pg. 5 for bin dimensions.



Q-Peg Wall Systems

Q-Peg Wall System starts with a heavy-duty Q-Peg Board which is durable, weather resistant and washable. This 1/4" thick, polypropylene board offers 3 times the holding power of traditional peg boards. Available in White.

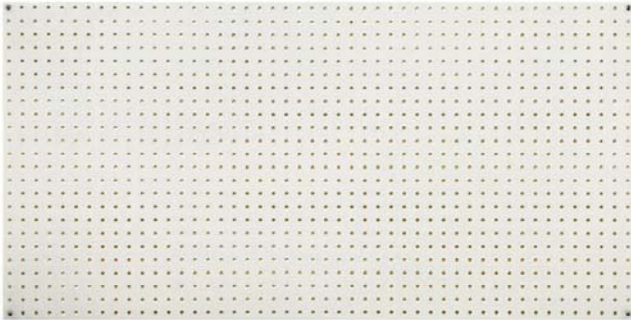

(1) PB-24X48-2

Spacer Kits

Installation of heavy-duty Q-Peg Wall System is easy with use of optional spacer kits. These kits create a small gap between the wall and board to allow for accessory installation. Kits do not require any special tools.

Each kit includes:

- 15 - #12, 2" length wood screws
- 15 - plastic wall anchors
- 15 - 3/8" steel wall spacers



MODEL NO.	DESCRIPTION	CTN QTY	CTN WGT
Q-Peg Wall Mount Board			
PB-24X48-2	24" x 48" x 1/4" Polypropylene	2	21 lbs
PB-24X48-4	24" x 48" x 1/4" Polypropylene	4	39 lbs
PB-SPACER-KT	Spacer Kit	15	1 lb

VERSATILE WALL STORAGE SOLUTION

Q-Peg Hooks and Accessories

Q-Peg Hooks and accessories can also be mounted on any standard 1/8" or 1/4" pegboard. All hooks can be mounted in different and unique positions to accommodate mostly anything. This unique and patented double locking system ensures all hardware will stay put and never fall out even after repetitive use or relocation. All accessories are listed on the opposite page.

Ultra Hang Bin Kits

Store supplies and tools with these popular bin sizes. Bin kits include bins and bin clips. Bins are available in Blue, Green, Ivory, Red, Yellow, Black and Clear. See chart on opposite page for ordering instructions. Optional bin dividers, window fronts and clear label holders are available on **pg. 5**.

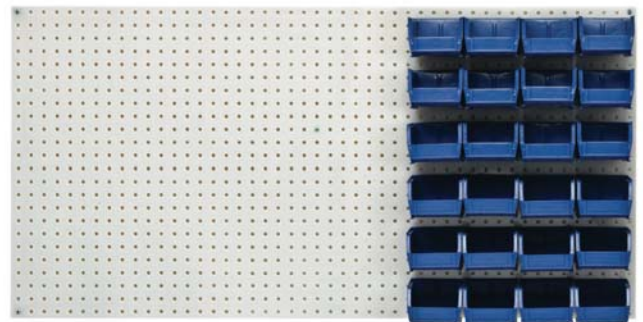

(1) PB-24X48-2 + PB-C-QUS220



LOWEST PRICE GUARANTEED!

Accessories

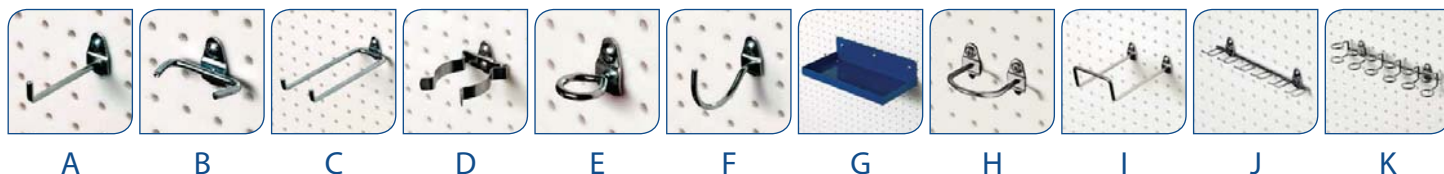

MODEL NO.	DESCRIPTION	CTN QTY	CTN WGT
Accessories			
A	PB-1X90-SR 1-1/8" Single Rod, 90° Bend	10	1 lb
	PB-1X30-SR 1" Single Rod, 30° Bend	10	1 lb
	PB-2X30-SR 2-1/2" Single Rod, 30° Bend	10	1 lb
	PB-2X90-SR 2-3/4" Single Rod, 90° Bend	10	2 lbs
	PB-4X30-SR 4" Single Rod, 30° Bend	10	1 lb
	PB-6X30-SR 6" Single Rod, 30° Bend	10	2 lbs
	PB-6X90-SR 6" Single Rod, 90° Bend	10	2 lbs
	PB-8X30-SR 8" Single Rod, 30° Bend	5	2 lbs
B	PB-1X1-PH 1-3/16" x 3/4" Plier Holder	10	1 lb
C	PB-3X80-DR 3" Double Rod, 80° Bend	10	1 lb
	PB-6X80-DR 6" Double Rod, 80° Bend	10	2 lbs
	PB-8X80-DR 8" Double Rod, 80° Bend	5	3 lbs
D	PB-HSC-SM 1/8" - 1/4" Spring Hold Clip	10	1 lb
	PB-HSC-XL 3/4" - 1-1/4" Spring Hold Clip	10	1 lb
	PB-HSC-MD 1/4" - 1/2" Spring Hold Clip	10	1 lb
	PB-HSC-LG 1/2" - 1" Spring Hold Clip	10	1 lb
	PB-SCH-SC Spring Clip, Spray Can Holder	5	1 lb
E	PB-SRTH Single Ring Tool Holder	10	1 lb
	PB-DRTH Double Ring Tool Holder	10	2 lbs
F	PB-2-CH 2-1/4" Curved Hook	10	1 lb
	PB-3-CH 3-3/4" Curved Hook	10	2 lbs
G	PB-6X12SHELF 12" x 6-1/2" Shelf	1	4 lbs
H	PB-3-DMU 3" Double Mounted U Shaped	5	1 lb
I	PB-5-DCEL 5" Double Closed End Loop	5	1 lb
	PB-8-DCEL 8" Double Closed End Loop	5	2 lbs
J	PB-MP-TWH Multi-Prong Tool / Wrench Holder	5	2 lbs
K	PB-MC-TSH Multi-Circle Tool / Screwdriver Holder	2	2 lbs
Bin Clips and Rails			
L	PB-BINCLIP Pegboard Bin Clip (1 clip required per bin)	5	1 lb
M	HNS006 12" Plastic Rail	2	1 lb

Bin Clips and Rails



L



M

Bin Kits

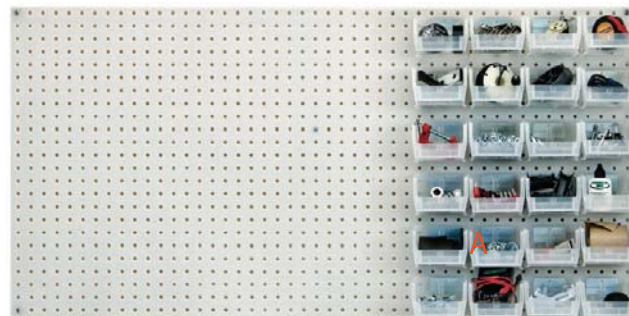

(1) PB-24X48-2 + PB-C-QUS220CL



(1) PB-24X48-2 + PB-C-QUS230CL

PERFORMANCE FEATURES:

- Systems offer 3 times the strength of traditional pegboard
- Q-Peg board is durable, weather resistant and washable
- Wide selection of accessories available to customize your unit

Available in: ● Blue ● Green ● Ivory ● Red ● Yellow ● Black ● Clear

MODEL NO.	NO. OF BINS/HOOKS	BIN DIMENSIONS L" x W" x H"	CTN QTY	CTN WGT
Bin Kits - Available in Blue, Green, Ivory, Red, Yellow or Black				
PB-C-QUS200	24	5" x 4-1/8" x 3"	24	8 lbs
PB-C-QUS210	24	5-3/8" x 4-1/8" x 3"	24	8 lbs
PB-C-QUS220	24	7-3/8" x 4-1/8" x 3"	24	11 lbs
PB-C-QUS230	12	10-7/8" x 5-1/2" x 5"	12	12 lbs
Clear Bin Kits				
PB-C-QUS200CL	24	5" x 4-1/8" x 3"	24	8 lbs
PB-C-QUS210CL	24	5-3/8" x 4-1/8" x 3"	24	8 lbs
PB-C-QUS220CL	24	7-3/8" x 4-1/8" x 3"	24	11 lbs
PB-C-QUS230CL	12	10-7/8" x 5-1/2" x 5"	12	12 lbs



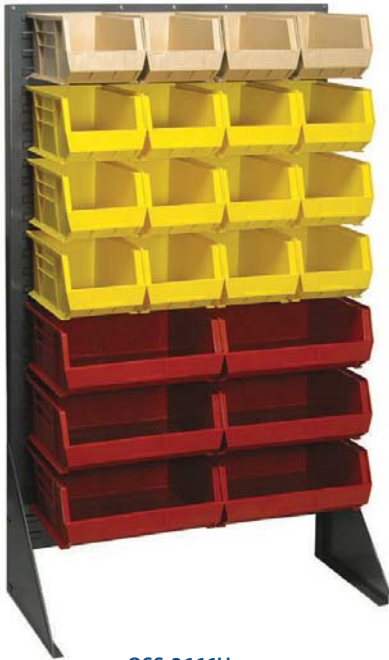

QSS-3666H

Single Sided Louvered Rack
36"L x 12-1/2"W x 66"H

Single sided unit accepts all sizes of Ultra Bins (up to 120 bins) 800 lb. capacity. Shown with QUS240 and QUS250 bins. (Bins sold separately)



QDS-3666H

Double Sided Louvered Rack
36"L x 25"W x 66"H

Mobile unit accepts all sizes of Ultra Bins (up to 240 bins) 2,000 lb. capacity. Shown with QUS235 bins. (Bins sold separately)



QMD-36H

Mobile Double Sided Louvered Rack
36"L x 25"W x 72"H

Mobile unit accepts all sizes of Ultra Bins (up to 240 bins). Comes complete with four 5" hard rubber, heavy-duty casters, 2 swivel and 2 rigid. 1,200 lb. capacity. Easy to pull handle included. Shown with QUS230 and QUS240 bins. (Bins sold separately)



QSS-1866H

Single Sided Louvered Rack
18"L x 12-1/2"W x 66"H

Single sided unit accepts all sizes of Ultra Bins (up to 60 bins) 375 lb. capacity. Shown with QUS245 bins. (Bins sold separately)



Slanted Shelf
see pg. 9

Flat Shelf
see pg. 9

Wire Mesh Bins
see pg. 6

Plastic Bins
see pg. 5

CUSTOMIZE YOUR OWN UNIT

1. Select the hanging unit of your choice.
2. Turn to pg. 5 and choose the bin that best fits your need.
3. Go to the chart at the bottom of this page and determine how many bins fit on the unit you selected.
4. Place your order for both unit and bins.

MODEL NO.	DIMENSIONS L" x W" x H"	CTN QTY	CTN WGT
Single Sided Unit, 375 lb. capacity			
QSS-1866H	18"L x 12-1/2"W x 66"H	1	40 lbs
Single Sided Unit, 800 lb. capacity			
QSS-3666H	36"L x 12-1/2"W x 66"H	1	60 lbs
Double Sided Unit, 2,000 lb. capacity			
QDS-3666H	36"L x 25"W x 66"H	1	106 lbs
Double Sided, Mobile Unit, 1,200 lb. capacity			
QMD-36H	36"L x 25"W x 72"H	1	155 lbs

QUANTITY OF ULTRA BINS TO FIT LOUVERED RACKS

MODEL NO.	QUS 200	QUS 210	QUS 220	QUS 221	QUS 224	QUS 230	QUS 234	QUS 235	QUS 239	QUS 240	QUS 241	QUS 242	QUS 245	QUS 250	QUS 255	QUS 260	QUS 265	QUS 270
QSS-1866H	60	60	60	30	30	30	30	30	15	14	14	14	12	10	7	5	12	5
QSS-3666H	120	120	120	60	80	60	60	30	28	28	28	24	20	14	21	15	24	10
QDS-3666H	240	240	240	120	160	120	120	60	56	56	48	40	28	42	30	40	40	20
QMD-36H	240	240	240	120	160	120	120	60	56	56	48	40	28	42	30	40	40	20

See pg. 5 for bin dimensions.



LOWEST PRICE GUARANTEED!



Hang-n-Stack Bins - Complete Packages

Comes with 2 handy 12" plastic rails ideal for mounting to any surface. Bins can hang or stack securely providing an efficient bin storage system. Available in Blue, Yellow, Red, Green, Ivory, Black and Clear. Rails available in White.

Ultra Rail Systems

Rails may be mounted on any suitable surface including walls, benches, inside service trucks and cabinets or on carts. Fasten securely to assure proper load bearing. Configure Rail System to meet your custom requirements. *(Bins sold separately)*



Steel Rail

48"L x 3"H Steel Rail mounts to any surface or workbench and accepts 13 sizes of Ultra bins *(up to 11 bins per rail)*. 125 lb. load capacity.

CUSTOMIZE YOUR OWN UNIT

1. Select the hanging unit of your choice.
2. Turn to **pg. 5** and choose the bin that best fits your need.
3. Go to the chart at the bottom of this page and determine how many bins fit on the unit you selected.
4. Place your order for both unit and bins.

MODEL NO.	BIN DIMENSIONS L" x W" x H"	DESCRIPTION	CTN WGT
HNS200	5" x 4-1/8" x 3"	6 bins + 2 rails	2 lbs
HNS210	5-3/8" x 4-1/8" x 3"	6 bins + 2 rails	2 lbs
HNS220	7-3/8" x 4-1/8" x 3"	6 bins + 2 rails	3 lbs
HNS230	10-7/8" x 5-1/2" x 5"	4 bins + 2 rails	5 lbs
HNS006	Extra Rails	2 rails	1 lb

MODEL NO.	DESCRIPTION	CTN QTY	CTN WGT
QRU-1W	48" Wall Rail	1	6 lbs



Shown with **24 QUS240** bins. *(Bins sold separately)*

QRU-12S
Single Sided Rack, 12 Rails

36"L x 15"W x 53"H
Accepts 12 sizes of Ultra bins *(up to 96 bins)*
600 lb. capacity. See chart for bin configurations.



Shown with **192 QUS220** bins. *(Bins sold separately)*

QRU-12D
Double Sided Rack, 12 Rails

36"L x 20"W x 53"H
Accepts 12 sizes of Ultra bins *(up to 192 bins)*
1,600 lb. capacity. See chart for bin configurations.



Shown with **96 QUS230** bins. *(Bins sold separately)*

QRU-16D + QRU-MOB
Double Sided Rack, 16 Rails with Mobile Kit

36"L x 20"W x 59"H
Accepts 6 sizes of Ultra bins *(up to 96 bins)*
1,000 lb. capacity. See chart for bin configurations.

QRU-12D + QRU-MOB
Double Sided Rack, 12 Rails with Mobile Kit
Accepts 12 sizes of Ultra bins *(up to 192 bins)*
1,000 lb. capacity. See chart for bin configurations.

QRU-16S
Single Sided Rack, 16 Rails
Accepts 6 sizes of Ultra bins *(up to 48 bins)*
600 lb. capacity. See chart for bin configurations.

QRU-16D
Double Sided Rack, 16 Rails
Accepts 6 sizes of Ultra bins *(up to 96 bins)*
1,600 lb. capacity. See chart for bin configurations.

MODEL NO.	DESCRIPTION	DIMENSIONS L" x W" x H"	QUANTITY OF ULTRA BINS TO FIT RAIL UNITS																	
			QUS 200	QUS 210	QUS 220	QUS 221	QUS 224	QUS 230	QUS 234	QUS 235	QUS 239	QUS 240	QUS 241	QUS 242	QUS 245	QUS 250	QUS 255	QUS 260	QUS 265	QUS 270
QRU-1W	48"L Steel Rail	48" x - x 3"	11	11	11	8	11	8	8	4	5	5	5	5	3	-	-	-	-	-
QRU-12S	Rack, 1 sided 12 rail	36" x 15" x 53"	96	96	96	-	-	-	-	-	24	24	24	20	-	12	12	12	20	8
QRU-16S	Rack, 1 sided 16 rail	36" x 15" x 53"	-	-	-	48	48	48	48	24	-	-	-	16	-	-	-	-	-	-
QRU-12D	Rack, 2 sided 12 rail	36" x 20" x 53"	192	192	192	-	-	-	-	-	48	48	48	40	-	24	24	24	40	16
QRU-16D	Rack, 2 sided 16 rail	36" x 20" x 53"	-	-	-	96	96	96	96	48	-	-	-	32	-	-	-	-	-	-
QRU-MOB	Mobile Kit - Mobilizes Double Sided Units																			

See pg. 5 for bin dimensions.



Single & Double Sided Rail Systems
Complete Packages

Single Sided Systems: 36"L x 15"W x 53"H offers 600 lb. capacity. Available in 4 different configurations.

Double Sided Systems: 36"L x 20"W x 53"H offers 1,600 lb. capacity. Available in 4 different configurations. Mobilize double sided system with the addition of **QRU-MOB**. Bins are available in Blue, Yellow, Red, Green, Ivory, Black and Clear.

QRU-16S-220230240



Bench Racks - Complete Packages

36"L x 8"W x 19"H and 27"L x 8"W x 21"H bench racks are available in 3 pre-configured choices. Bench racks can be joined together to form continuous systems. Bins are available in Blue, Yellow, Red, Green, Ivory, Black and Clear.

QBR-3619-210-32



Louvered Panels - Complete Packages

18"L x 19"H, 36"L x 19"H, 36"L x 61"H and 48"L x 61"H panels are available in 3 configurations. Louvered Panels are available in Gray or Oyster White color. To order an Oyster White Louvered Panel add HC to the model number (i.e. **QLP-1819HC-210-18**). Bins are available in Blue, Yellow, Red, Green, Ivory, Black and Clear.

QLP-1819-220-16



Mobile Double Sided Louvered Rack Systems - Complete Packages

36"L x 25"W x 72"H mobile system offers 1,200 lb. capacity. Bins available in Blue, Yellow, Red, Green, Ivory, Black and Clear.



QMD-36H-230240



MODEL NO.	NO. OF BINS	BIN DIMENSION L" x W" x H"	SHIP WGT
36" L x 15" W x 53" H Single Sided Rail Systems			
QRU-12S-220-96	96	7-3/8" x 4-1/8" x 3"	82 lbs
QRU-16S-230-48	48	10-7/8" x 5-1/2" x 5"	108 lbs
QRU-12S-240-24	24	14-3/4" x 8-1/4" x 7"	102 lbs
	16	7-3/8" x 4-1/8" x 3"	
QRU-16S-220230240	18	10-7/8" x 5-1/2" x 5"	108 lbs
	12	14-3/4" x 8-1/4" x 7"	
36" L x 20" W x 53" H Double Sided Rail Systems			
QRU-12D-220-192	192	7-3/8" x 4-1/8" x 3"	113 lbs
QRU-16D-230-96	96	10-7/8" x 5-1/2" x 5"	155 lbs
QRU-12D-240-48	48	14-3/4" x 8-1/4" x 7"	153 lbs
QRU-MOB	Mobile Kit - Mobilizes Double Sided Systems		25 lbs

MODEL NO.	NO. OF BINS	BIN DIMENSIONS L" x W" x H"	SHIP WGT
27" L x 8" W x 21" H Bench Racks			
QBR-2721-210-24	24	5-3/8" x 4-1/8" x 3"	23 lbs
QBR-2721-220-24	24	7-3/8" x 4-1/8" x 3"	25 lbs
QBR-2721-230-12	12	10-7/8" x 5-1/2" x 5"	28 lbs
36" L x 8" W x 19" H Bench Racks			
QBR-3619-210-32	32	5-3/8" x 4-1/8" x 3"	29 lbs
QBR-3619-220-32	32	7-3/8" x 4-1/8" x 3"	31 lbs
QBR-3619-230-18	18	10-7/8" x 5-1/2" x 5"	37 lbs

MODEL NO.	NO. OF BINS	BIN DIMENSIONS L" x W" x H"	SHIP WGT
18" L x 19" H Louvered Panels			
QLP-1819-210-16	16	5-3/8" x 4-1/8" x 3"	11 lbs
QLP-1819-220-16	16	7-3/8" x 4-1/8" x 3"	12 lbs
QLP-1819-230-9	9	10-7/8" x 5-1/2" x 5"	16 lbs
36" L x 19" H Louvered Panels			
QLP-3619-210-32	32	5-3/8" x 4-1/8" x 3"	22 lbs
QLP-3619-220-32	32	7-3/8" x 4-1/8" x 3"	24 lbs
QLP-3619-230-18	18	10-7/8" x 5-1/2" x 5"	30 lbs
36" L x 61" H Louvered Panels			
QLP-3661-220-120	120	7-3/8" x 4-1/8" x 3"	80 lbs
QLP-3661-230-60	60	10-7/8" x 5-1/2" x 5"	90 lbs
QLP-3661-240-28	28	14-3/4" x 8-1/4" x 7"	96 lbs
48" L x 61" H Louvered Panels			
QLP-4861-220-165	165	7-3/8" x 4-1/8" x 3"	115 lbs
QLP-4861-230-80	80	10-7/8" x 5-1/2" x 5"	127 lbs
QLP-4861-240-35	35	14-3/4" x 8-1/4" x 7"	130 lbs

MODEL NO.	NO. OF BINS	BIN DIMENSIONS L" x W" x H"	SHIP WGT
QMD-36H-220	240	7-3/8" x 4-1/8" x 3"	174 lbs
QMD-36H-230	120	10-7/8" x 5-1/2" x 5"	212 lbs
QMD-36H-240	56	14-3/4" x 8-1/4" x 7"	208 lbs
	72	10-7/8" x 5-1/2" x 5"	
QMD-36H-230240	24	14-3/4" x 8-1/4" x 7"	217 lbs

COMPLETE PACKAGES WITH BINS



LOWEST PRICE GUARANTEED!

Giant Open Hopper Steel Shelving Systems - Complete Packages

CLEAR VIEW
 AVAILABLE on pg. 22

These economical high density bin storage systems include heavy-duty giant stack bins with open hopper fronts for easy access. Optional clear window fronts maximize capacity, prevent spillage and convert the bin to a true tote. Optional dividers keep contents organized - available on **pg. 5**. Heavy-duty, high grade shelving with 400 lb. capacity per shelf. Bins available in Blue, Yellow, Red, Green, Ivory, Black and Clear.

COMPLETE PACKAGES WITH BINS

12" Deep Systems

18" Deep Systems



QSBU-230240
 12"D x 36"W x 75"H
10 shelves and 36 QUS230
 10-7/8"L x 5-1/2"W x 5"H bins
 and **12 QUS240**
 14-3/4"L x 8-1/4"W x 7"H bins



QSBU-239
 12"D x 36"W x 75"H
8 shelves and 28 QUS239
 10-3/4"L x 8-1/4"W x 7"H bins



QSBU-255
 18"D x 36"W x 75"H
8 shelves and 21 QUS255
 16"L x 11"W x 8"H bins
(Windows sold separately)



QSBU-260
 18"D x 36"W x 75"H
6 shelves and 15 QUS260
 18"L x 11"W x 10"H bins
(Windows and dividers sold separately)



QSBU-240
 12"D x 36"W x 75"H
8 shelves and 28 QU240
 14-3/4"L x 8-1/4"W x 7"H bins



QSBU-250
 12"D x 36"W x 75"H
8 shelves and 14 QUS250
 14-3/4"L x 16-1/2"W x 7"H bins



QSBU-265
 18"D x 36"W x 75"H
7 shelves and 24 QUS265
 18"L x 8-1/4"W x 9"H bins



QSBU-270
 18"D x 36"W x 75"H
6 shelves and 10 QUS270
 18"L x 16-1/2"W x 11"H bins

Giant Open Hopper Wire Shelving Systems - Complete Packages



MOBILIZE YOUR WIRE SHELVING

DB - Donut Bumper
Non-marking donut bumper used to protect walls and help cushion impact.

WR-00H (Mobile Kit)*
Set of four swivel polyurethane 5" x 1-1/4" casters, two with brakes. Can be used with all units shown. 1,200 lb. load capacity. *Mobile kits recommended only for shelves 18" and wider.

COMPLETE PACKAGES WITH BINS

12" and 14" Deep Systems

18" Deep Systems



WR8-239

12"W x 36"L x 74"H
8 shelves and 28 QUS239
10-3/4"L x 8-1/4"W x 7"H bins



WR8-240

14"W x 36"L x 74"H
8 shelves and 28 QU240
14-3/4"L x 8-1/4"W x 7"H bins



WR8-255

18"W x 36"L x 74"H
8 shelves and 21 QUS255
16"L x 11"W x 8"H bins



WR6-260

18"W x 36"L x 74"H
6 shelves and 15 QUS260
18"L x 11"W x 10"H bins



WR8-250

14"W x 36"L x 74"H
8 shelves and 14 QUS250
14-3/4"L x 16-1/2"W x 7"H bins



WR10-230240

14"W x 36"L x 74"H
10 shelves and 36 QUS230
10-7/8"L x 5-1/2"W x 5"H bins and
12 QUS240 14-3/4"L x 8-1/4"W x 7"H bins



WR6-265

18"W x 36"L x 74"H
6 shelves and 20 QUS265
18"L x 8-1/4"W x 9"H bins



WR5-270

18"W x 36"L x 74"H
5 shelves and 8 QUS270
18"L x 16-1/2"W x 11"H bins



LOWEST PRICE GUARANTEED!

36" Wide All-Welded Bin Cabinets



All-Purpose cabinets provide secure storage for your valuable parts and tools. Standard performance features: ships completely assembled, ready to use, 14 gauge all-welded construction, gray baked-enamel finish which ensures years of heavy-duty service, 3 point locking handle supplied with 2 keys. To order a Beige cabinet, add BG right after cabinet prefix (i.e. **QSC-BG-36** or **MESH-BG-240** or **QPR-BG-101**). Bins are available in Blue, Green, Ivory, Red, Yellow, Black and Clear. See **pg. 5** for bin dimensions.



QSC-36

36"W x 24"D x 72"H. Total of **132** bins. Deep Door Model. Ship wt. 425 lbs.
48 QUS210, 48 QUS220, 18 QUS230, 12 QUS240 and 6 QUS250.

COMPLETE PACKAGES WITH BINS



QSC-36S

36"W x 24"D x 72"H. Total of **102** bins. Deep Door Model. Ship wt. 465 lbs.
48 QUS210, 48 QUS220, 6 QUS250 and 3 adjustable shelves.
800 lb. capacity per interior shelf.



QSC-64-2S-6DS

36"W x 24"D x 72"H. Total of **64** bins. Deep Door Model. Ship wt. 427 lbs.
16 QUS240, 48 QUS220, 2 adjustable interior shelves and 6 door shelves.
800 lb. capacity per interior shelf. 60 lb. capacity per door shelf.

CABINETS AVAILABLE IN GRAY OR BEIGE COLOR



QSC-36-96-4IS

36"W x 24"D x 72"H. Total of **96** bins. Deep Door Model. Ship wt. 377 lbs.
96 QUS210 and 4 adjustable interior shelves.
800 lb. capacity per interior shelf.



QSC-36-FD

36"W x 18"D x 72"H. Total of **36** bins. Flush Door Model. Ship wt. 359 lbs.
18 QUS230, 12 QUS240 and 6 QUS250.

14 GAUGE ALL-WELDED STEEL CONSTRUCTION READY TO USE



QSC-36-4IS-12DS

36"W x 24"D x 72"H. Deep Door Model. Ship wt. 308 lbs.
4 adjustable interior shelves and 12 door shelves.
800 lb. capacity per interior shelf. 60 lb. capacity per door shelf.



QPR-101

Sloped Shelf Pick Rack Flow Cabinet
36"W x 18"D x 78"H.
Total of **72** bins. Flush Door Model.
Ship wt. 298 lbs. **Eight** sloped shelves
and **one** flat shelf hold **72 QSB101**.
Additional cabinet configurations listed
below. Bins available in Blue, Green,
Ivory, Red, Yellow, Black and Clear.
500 lb. capacity per interior shelf.



MODEL NO.	NO. OF BINS	BIN MODEL	SHIP WGT
QPR-101	72	QSB101	298 lbs
QPR-102	45	QSB102	294 lbs
QPR-107	36	QSB107	289 lbs

See pg. 5 for bin dimensions.

**CABINETS
AVAILABLE IN GRAY
OR BEIGE COLOR**

MESH-240

Wire Mesh Safe-View Bin Cabinet
36"W x 18"D x 78"H.
Total of **36** bins. Mesh Door Model.
Ship wt. 290 lbs. Louvered back wall fits
36 QUS240. Additional cabinet configura-
tions listed below. Bins available in Blue,
Green, Ivory, Red, Yellow, Black and Clear.

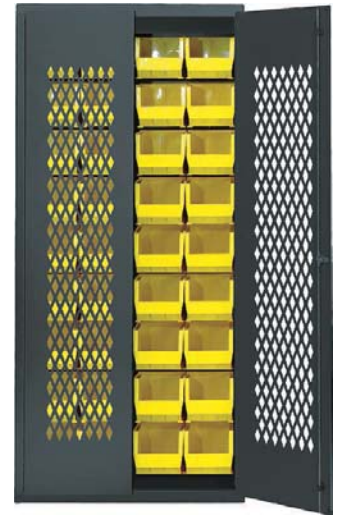

MODEL NO.	NO. OF BINS	BIN MODEL	SHIP WGT
MESH-240	36	QUS240	290 lbs
MESH-240250	20	QUS240	303 lbs
	8	QUS250	
MESH-250	18	QUS250	288 lbs

See pg. 5 for bin dimensions.

**COMPLETE
PACKAGES
WITH BINS**



QSC-36-MIN

36"W x 24"D x 36"H.

Total of **66** bins. Ship wt. 218 lbs. **24 QUS210, 24 QUS220, 12 QUS230, 4 QUS240**
and **2 QUS250**. Bins available in Blue, Green, Ivory, Red, Yellow, Black and Clear.

See pg. 5 for bin dimensions.

QSC-C240250

Clear-View Security Bin Cabinet

36"W x 18"D x 78"H.

Total of **28** bins. Clear Door Model.
Ship wt. 388 lbs. Louvered back wall fits
20 QUS240 and **8 QUS250**. Additional
cabinet configurations listed below.
Bins available in Blue, Green, Ivory,
Red, Yellow, Black and Clear.



MODEL NO.	NO. OF BINS	BIN MODEL	SHIP WGT
QSC-C240	36	QUS240	390 lbs
QSC-C240250	20	QUS240	388 lbs
	8	QUS250	
QSC-C250	18	QUS250	392 lbs

See pg. 5 for bin dimensions.



QSC-QIC161

Interlocking Drawer Storage Cabinet

48"W x 24"D x 78"H.

Total of **128** bins and **15** Interlocking Drawer Cabinets. Ship wt. 507 lbs. Louvered door
fits **128 QUS210** bins (see pg. 5 for bin dimensions). Shelves hold **15** Interlocking Cabinet
Units. Interlocking Cabinets have a Gray exterior, Drawers are available in Blue, Red, Ivory
and Gray. Door bins available in Blue, Green, Ivory, Red, Yellow, Black and Clear.
400 lb. capacity per interior shelf.

MODEL NO.	CABINET MODEL	NO. OF DRAWERS	SHIP WGT
QSC-QIC161	QIC-161	240	507 lbs
QSC-QIC122	QIC-122	180	507 lbs
QSC-QIC83	QIC-83	120	492 lbs
QSC-QIC64	QIC-64	90	492 lbs

See pg. 92 for cabinet and drawer dimensions.



QSC-3672-4D

36"W x 24"D x 72"H.

Flush Door Model. Comes complete with **one** 18" adjustable shelf, **12** door shelves,
four 31"W x 16"D drawers: **two** are 3" high, **one** is 5" high, **one** is 6" high.
Ship wt. 663 lbs. Total of **58** removable bins: **36 QUS220, 18 QUS230** and **4 QUS240**.
Bins available in Blue, Green, Ivory, Red, Yellow, Black and Clear.
800 lb. capacity per interior shelf. 60 lb. capacity per door shelf.
See pg. 5 for bin dimensions.



LOWEST PRICE GUARANTEED!

48" Wide All-Welded Bin Cabinets



These 48" wide models offer all of the features of the 36", but with additional storage space. All cabinets are also available in Beige color. To order a Beige cabinet, add BG right after cabinet prefix (i.e. **QSC-BG-48** or **MESH-BG-240** or **QPR-BG-101**). Bins are available in Blue, Green, Ivory, Red, Yellow, Black and Clear. See **pg. 5** for bin dimensions.



QSC-48

48"W x 24"D x 78"H. Total of 171 bins. Flush Door Model. Ship wt. 522 lbs.
64 QUS210, 64 QUS220, 24 QUS230, 13 QUS240 and 6 QUS250.

COMPLETE PACKAGES WITH BINS



QSC-48S

48"W x 24"D x 78"H. Total of 137 bins. Flush Door Model. Ship wt. 534 lbs.
64 QUS210, 64 QUS220, 3 QUS240, 6 QUS250 and 3 adjustable shelves.
400 lb. capacity per interior shelf.



QSC-4803

48"W x 24"D x 78"H. Total of 128 bins. Flush Door Model. Ship wt. 505 lbs.
128 QUS210 and 4 adjustable interior shelves.
400 lb. capacity per interior shelf.

CABINETS AVAILABLE IN GRAY OR BEIGE COLOR



QSC-4804

48"W x 24"D x 78"H. Total of 84 bins. Flush Door Model. Ship wt. 515 lbs.
20 QUS240, 64 QUS220, 2 adjustable interior shelves and 6 door shelves.
400 lb. capacity per interior shelf. 60 lb. capacity per door shelf.



QSC-4805

48"W x 24"D x 78"H. Total of 64 bins. Flush Door Cabinet. Ship wt. 484 lbs.
64 QUS210 and punched panels on inside rear wall and doors,
2 adjustable interior shelves. 400 lb. capacity per interior shelf.

PERFECT FOR JANITORIAL AND MAINTENANCE STORAGE



QSC-4IS-14DS

48"W x 24"D x 84"H. Deep Door Model. Ship wt. 572 lbs.
4 adjustable interior shelves and 14 adjustable door shelves.
400 lb. capacity per interior shelf. 60 lb. capacity per door shelf.

Super-Wide Colossal Heavy-Duty Cabinets



Super-wide, colossal cabinets offer 60" or 72" widths and 84" heights allowing for maximum and efficient storage while providing superior strength and security. Standard performance features: ships completely assembled, ready to use, 14 gauge all-welded construction, gray or beige baked-enamel finish which ensures years of heavy-duty service, 3 point locking handle with provision for a padlock (*not included*) and 6" high legs make cabinets fork truck liftable. To order a Beige cabinet, add BG right after cabinet prefix (*i.e. QSC-BG-60 or MESH-BG-240 or QPR-BG-101*). Bins are available in Blue, Green, Ivory, Red, Yellow, Black and Clear. See **pg. 5** for bin dimensions.



QSC-60

60"W x 24"D x 84"H. Total of **227** bins. Flush Door Model. Ship wt. 860 lbs.
80 QUS210, 90 QUS220, 30 QUS230, 18 QUS240 and 9 QUS250.



QSC-60S

60"W x 24"D x 84"H. Total of **185** bins. Flush Door Model. Ship wt. 878 lbs.
80 QUS210, 90 QUS220, 6 QUS240, 9 QUS250 and 3 adjustable shelves.
 500 lb. capacity per interior shelf.

COMPLETE PACKAGES WITH BINS

CABINETS AVAILABLE IN GRAY OR BEIGE COLOR



QSC-72

72"W x 24"D x 84"H. Total of **264** bins. Flush Door Model. Ship wt. 1,002 lbs.
96 QUS210, 96 QUS220, 36 QUS230, 24 QUS240 and 12 QUS250.



QSC-72S

72"W x 24"D x 84"H. Total of **212** bins. Flush Door Model. Ship wt. 955 lbs.
96 QUS210, 96 QUS220, 8 QUS240, 12 QUS250 and 3 adjustable shelves.
 500 lb. capacity per interior shelf.



LOWEST PRICE GUARANTEED!

48" Wide All-Welded Cabinet



This 48" wide model offers all the features of the 36", but offer additional storage space. Cabinets is also available in Beige color. To order a Beige cabinet, add BG right after cabinet prefix (i.e. **QSC-BG-3IS**).



QSC-3IS

48"W x 24"D x 78"H. Flush Door Model. Ship wt. 323 lbs. 3 adjustable shelves. 400 lb. capacity per shelf.



60" Work Bench/Cabinet

CABINETS AVAILABLE IN GRAY OR BEIGE COLOR



PERFECT WAIST & WORK HEIGHT

QSC-60-BENCH

60"W x 30"D x 36"H

Work Bench/Cabinet Combo. Total of **20** bins. Ship wt. 375 lbs. **20 QUS210**, 1 shelf and 4 drawers.

The working surface is covered by a 60"W x 30"D x 2"H maple top for rugged durability. Bins are available in Blue, Yellow, Green, Red, Ivory, Black and Clear.

Mobile Rail Carts

COMPLETE PACKAGES WITH BINS

MODEL NO.	DESCRIPTION	QUS 200	QUS 210	QUS 220	QUS 230	QUS 235	QUS 239
Quantity of Ultra Bins to Fit Rail Carts							
QRC-4D	36" x 24" Rail Cart	64	64	64	48	24	16
QRC-7D	36" x 18" Rail Cart	96	96	96	-	-	-

See pg. 5 for bin dimensions.



QRC-4D

Mobile Ergonomic Cart

36"L x 24"W x 35-1/2"H

Accepts 6 sizes of Ultra Bins (up to **64** bins). Includes **2** rigid and **2** swivel, with brake, casters. 800 lb. load capacity.

Bins are available in Blue, Yellow, Green, Red, Ivory, Black and Clear. (Bins sold separately)



QRC-7D

Mobile Ergonomic Cart

36"L x 18"W x 35-1/2"H

Accepts 3 sizes of Ultra Bins (up to **96** bins). Includes **2** rigid and **2** swivel, with brake, casters. 800 lb. load capacity.

Bins are available in Blue, Yellow, Green, Red, Ivory, Black and Clear. (Bins sold separately)

Clear-View Ultra Stack and Hang Bins



Organize your inventory with strong injection molded tri-clear polypropylene bins. Front, back and side grips for easy handling. Built in rear hanger allows bins to hang from louvered panels or rails. Optional clear injection molded crystal styrene window fronts increases bin capacity and provides quick view of bin contents. Dividers maximize flexibility and keep contents organized. Wide stacking ledge and anti-slide lock keep stacked bins steady and prevent forward shifting. Waterproof bins resist rust and corrosion. Large molded front label slots for ID labels. Autoclavable up to 250°F and resistant to extreme cold.



QUANTUM IS CLEARLY YOUR STORAGE SOLUTION



MOBILIZE YOUR WIRE SHELVING

DB - Donut Bumper

Non-marking donut bumper used to protect walls and help cushion impact.

WR-00H (Mobile Kit)*

Set of four swivel polyurethane 5" x 1-1/4" casters, two with brakes. Can be used with all units shown. 1,200 lb. load capacity. *Mobile kits recommended only for shelves 18" and wider.

COMPLETE PACKAGES WITH BINS



WR8-240CL



QSBU-240CL

Available in: ● Clear

MODEL NO.	OUTSIDE DIMENSIONS L" x W" x H"	CTN QTY	CTN WGT
QUS200CL	5" x 4-1/8" x 3"	24	5 lbs
QUS210CL	5-3/8" x 4-1/8" x 3"	24	6 lbs
QUS220CL	7-3/8" x 4-1/8" x 3"	24	8 lbs
QUS221CL	9-1/4" x 6" x 5"	12	6 lbs
QUS224CL	10-7/8" x 4-1/8" x 4"	12	8 lbs
QUS230CL	10-7/8" x 5-1/2" x 5"	12	10 lbs
QUS234CL	14-3/4" x 5-1/2" x 5"	12	14 lbs
QUS235CL	10-7/8" x 11" x 5"	6	10 lbs
QUS239CL	10-3/4" x 8-1/4" x 7"	6	10 lbs
QUS240CL	14-3/4" x 8-1/4" x 7"	12	24 lbs
QUS241CL	13-5/8" x 8-1/4" x 6"	12	22 lbs
QUS242CL	13-5/8" x 8-1/4" x 8"	12	25 lbs
QUS245CL	10-7/8" x 16-1/2" x 5"	6	13 lbs
QUS250CL	14-3/4" x 16-1/2" x 7"	6	21 lbs
QUS255CL	16" x 11" x 8"	4	14 lbs
QUS260CL	18" x 11" x 10"	4	17 lbs
QUS265CL	18" x 8-1/4" x 9"	6	17 lbs
QUS270CL	18" x 16-1/2" x 11"	3	16 lbs
QUS275MOBCL	18" x 16-1/2" x 11"	3	25 lbs

* With casters, overall height for mobile container will be increased by 3"
Individual labels are available for all Ultra Bins. Ctn Qty: 50 Individual Labels
For label Model No., substitute "L" for "Q" in bin Model No.

Clear-View Ultra Stack and Hang Bin Wire Shelving Systems - Complete Packages

MODEL NO.	NO. OF SHELVES	NO. OF BINS	BIN SIZE L" x W" x H"	SHIP WGT
12" x 36" x 74" Systems				
WR8-239CL	8	28 QUS239CL	10-3/4" x 8-1/4" x 7"	103 lbs
WR7-245CL	7	24 QUS245CL	10-7/8" x 16-1/2" x 5"	111 lbs
14" x 36" x 74" Systems				
WR10-230240CL	10	36 QUS230CL 12 QUS240CL	10-7/8" x 5-1/2" x 5" 14-3/4" x 8-1/4" x 7"	146 lbs
WR8-240CL	8	28 QUS240CL	14-3/4" x 8-1/4" x 7"	128 lbs
WR8-250CL	8	14 QUS250CL	14-3/4" x 16-1/2" x 7"	129 lbs
18" x 36" x 74" Systems				
WR8-255CL	8	21 QUS255CL	16" x 11" x 8"	152 lbs
WR6-260CL	6	15 QUS260CL	18" x 11" x 10"	127 lbs
WR6-265CL	6	20 QUS265CL	18" x 8-1/4" x 9"	124 lbs
WR5-270CL	5	8 QUS270CL	18" x 16-1/2" x 11"	104 lbs

Clear-View Ultra Stack and Hang Bin Steel Shelving Systems - Complete Packages

See pg. 5 for accompanying dividers, clear window fronts and clear label holders.

MODEL NO.	NO. OF SHELVES	NO. OF BINS	BIN SIZE L" x W" x H"	SHIP WGT
12" x 36" x 75" Systems				
QSBU-239CL	8	28 QUS239CL	10-3/4" x 8-1/4" x 7"	99 lbs
QSBU-230240CL	10	36 QUS230CL 12 QUS240CL	10-7/8" x 5-1/2" x 5" 14-3/4" x 8-1/4" x 7"	122 lbs
QSBU-240CL	8	28 QUS240CL	14-3/4" x 8-1/4" x 7"	110 lbs
QSBU-245CL	7	24 QUS245CL	10-7/8" x 16-1/2" x 5"	111 lbs
QSBU-250CL	8	14 QUS250CL	14-3/4" x 16-1/2" x 7"	99 lbs
18" x 36" x 75" Systems				
QSBU-255CL	8	21 QUS255CL	16" x 11" x 8"	140 lbs
QSBU-260CL	6	15 QUS260CL	18" x 11" x 10"	120 lbs
QSBU-265CL	7	24 QUS265CL	18" x 8-1/4" x 9"	134 lbs
QSBU-270CL	6	10 QUS270CL	18" x 16-1/2" x 11"	117 lbs



LOWEST PRICE GUARANTEED!



QPL-1819-230-9CL



QBR-2721-220-24CL



Clear-View 12" Plastic Rail Systems Complete Packages

Comes with 2 handy 12" plastic rails ideal for mounting to any surface. Bins can hang or stack securely providing an efficient bin storage system. Available in Clear. Rails available in White.

MODEL NO.	BIN DIMENSIONS L" x W" x H"	DESCRIPTION	SHIP WGT
HNS200CL	5" x 4-1/8" x 3"	6 bins + 2 rails	2 lbs
HNS210CL	5-3/8" x 4-1/8" x 3"	6 bins + 2 rails	2 lbs
HNS220CL	7-3/8" x 4-1/8" x 3"	6 bins + 2 rails	3 lbs
HNS230CL	10-7/8" x 5-1/2" x 5"	4 bins + 2 rails	5 lbs
HNS006	Extra Rails	2 rails	1 lb



HNS230CL

COMPLETE PACKAGES WITH BINS



QMD-36H-240CL



QRU-12D-220-192CL + QRU-MOB
Double Sided Rack, 12 Rails with Mobile Kit
1,000 lb. capacity.

Clear-View Bench Racks & Louvered Panel Systems - Complete Packages

Bench Racks: 36"L x 8"W x 19"H and 27"L x 8"W x 21"H. Both bench racks are available in 3 preconfigured choices. Bench racks can be joined together to form continuous systems.

Louvered Panels: 18"L x 19"H, 36"L x 19"H, 36"L x 61"H and 48"L x 61"H panels are available in 3 configurations. Louvered Panels are available in Gray or Oyster White color. To order an Oyster White Louvered Panel add HC to the model number (i.e. **QLP-1819HC-210-18CL**). Bins are available in Clear.

MODEL NO.	NO. OF BINS	BIN DIMENSION L" x W" x H"	SHIP WGT
27"L x 8"W x 21"H Bench Rack Systems			
QBR-2721-210-24CL	24 QUS210CL	5-3/8" x 4-1/8" x 3"	23 lbs
QBR-2721-220-24CL	24 QUS220CL	7-3/8" x 4-1/8" x 3"	25 lbs
QBR-2721-230-12CL	12 QUS230CL	10-7/8" x 5-1/2" x 5"	28 lbs
36"L x 8"W x 19"H Bench Rack Systems			
QBR-3619-210-32CL	32 QUS210CL	5-3/8" x 4-1/8" x 3"	29 lbs
QBR-3619-220-32CL	32 QUS220CL	7-3/8" x 4-1/8" x 3"	31 lbs
QBR-3619-230-18CL	18 QUS230CL	10-7/8" x 5-1/2" x 5"	37 lbs
18"L x 19"H Louvered Panel Systems			
QLP-1819-210-16CL	16 QUS210CL	5-3/8" x 4-1/8" x 3"	11 lbs
QLP-1819-220-16CL	16 QUS220CL	7-3/8" x 4-1/8" x 3"	12 lbs
QLP-1819-230-9CL	9 QUS230CL	10-7/8" x 5-1/2" x 5"	16 lbs
36"L x 19"H Louvered Panel Systems			
QLP-3619-210-32CL	32 QUS210CL	5-3/8" x 4-1/8" x 3"	22 lbs
QLP-3619-220-32CL	32 QUS220CL	7-3/8" x 4-1/8" x 3"	24 lbs
QLP-3619-230-18CL	18 QUS230CL	10-7/8" x 5-1/2" x 5"	30 lbs
36"L x 61"H Louvered Panel Systems			
QLP-3661-220-120CL	120 QUS220CL	7-3/8" x 4-1/8" x 3"	80 lbs
QLP-3661-230-60CL	60 QUS230CL	10-7/8" x 5-1/2" x 5"	90 lbs
QLP-3661-240-28CL	28 QUS240CL	14-3/4" x 8-1/4" x 7"	96 lbs
48"L x 61"H Louvered Panel Systems			
QLP-4861-220-165CL	165 QUS220CL	7-3/8" x 4-1/8" x 3"	115 lbs
QLP-4861-230-80CL	80 QUS230CL	10-7/8" x 5-1/2" x 5"	127 lbs
QLP-4861-240-35CL	35 QUS240CL	14-3/4" x 8-1/4" x 7"	130 lbs

Clear-View Rail Systems - Complete Packages

MODEL NO.	NO. OF BINS	BIN DIMENSION L" x W" x H"	SHIP WGT
36"L x 15"W x 53"H Single Sided Rail Systems			
QRU-125-220-96CL	96 QUS220CL	7-3/8" x 4-1/8" x 3"	82 lbs
QRU-165-230-48CL	48 QUS230CL	10-7/8" x 5-1/2" x 5"	108 lbs
QRU-125-240-24CL	24 QUS240CL	14-3/4" x 8-1/4" x 7"	102 lbs
QRU-165-220230240CL	16 QUS220CL	7-3/8" x 4-1/8" x 3"	108 lbs
	18 QUS230CL	10-7/8" x 5-1/2" x 5"	
QRU-165-220230240CL	12 QUS240CL	14-3/4" x 8-1/4" x 7"	108 lbs
	18 QUS230CL	10-7/8" x 5-1/2" x 5"	
36"L x 20"W x 53"H Double Sided Rail Systems			
QRU-12D-220-192CL	192 QUS220CL	7-3/8" x 4-1/8" x 3"	113 lbs
QRU-16D-230-96CL	96 QUS230CL	10-7/8" x 5-1/2" x 5"	155 lbs
QRU-12D-240-48CL	48 QUS240CL	14-3/4" x 8-1/4" x 7"	153 lbs
QRU-MOB	Mobile Kit - Mobilizes Double Sided Systems		25 lbs

Clear-View Mobile Double Sided Louvered Rack Systems - Complete Packages

36"L x 25"W x 72"H Mobile unit 1,200 lb. capacity. Bins available in Clear.

MODEL NO.	NO. OF BINS	BIN DIMENSION L" x W" x H"	SHIP WGT
QMD-36H-220CL	240 QUS220CL	7-3/8" x 4-1/8" x 3"	174 lbs
QMD-36H-230CL	120 QUS230CL	10-7/8" x 5-1/2" x 5"	212 lbs
QMD-36H-240CL	56 QUS240CL	14-3/4" x 8-1/4" x 7"	208 lbs
QMD-36H-230240CL	72 QUS230CL	10-7/8" x 5-1/2" x 5"	217 lbs
	24 QUS240CL	14-3/4" x 8-1/4" x 7"	

Clear-View HULK 24" Containers



Organize and store your large and bulky items with these strong injection molded tri-clear polypropylene, stackable containers. These extra large stacking containers offer a generous 2 feet in length to store your larger items. Heavy-duty front, back and side grips allow for easy handling. Clear window fronts & dividers available on **pg. 36**. Wide stacking ledge and anti-slide lock keep stacked bins steady and prevent forward shifting. Waterproof bins resist rust and corrosion. Bins are autoclavable up to 250°F and are resistant to extreme cold.

Available in: ● Clear

MODEL NO.	OUTSIDE DIMENSIONS L" x W" x H"	CTN QTY	CTN WGT
QUS950CL	23-7/8" x 8-1/4" x 7"	6	18 lbs
QUS951CL	23-7/8" x 8-1/4" x 9"	6	21 lbs
QUS952CL	23-7/8" x 11" x 7"	4	14 lbs
QUS953CL	23-7/8" x 11" x 10"	4	18 lbs
QUS954CL	23-7/8" x 16-1/2" x 11"	1	7 lbs
QUS964MOBCL	23-7/8" x 16-1/2" x 11"*	1	9 lbs
QUS955CL	23-7/8" x 18-1/4" x 12"	1	8 lbs
QUS965MOBCL	23-7/8" x 18-1/4" x 12"*	1	10 lbs

* With casters, overall height for mobile container will be increased by 3"

QUANTUM IS CLEARLY YOUR STORAGE SOLUTION

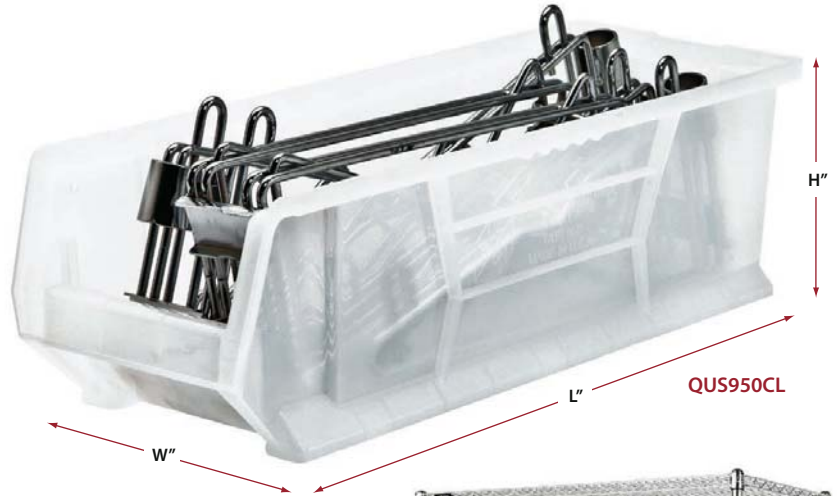

COMPLETE PACKAGES WITH BINS



Clear-View HULK 24" Container Wire Shelving Systems - Complete Packages

MODEL NO.	NO. OF SHELVES	NO. OF BINS	BIN SIZE L" x W" x H"	SHIP WGT
24" x 36" x 74" Systems				
WR8-950CL	8	28 QUS950CL	23-7/8" x 8-1/4" x 7"	205 lbs
WR8-950952CL	8	12 QUS950CL	23-7/8" x 8-1/4" x 7"	197 lbs
		12 QUS952CL	23-7/8" x 11" x 7"	
WR8-952CL	8	21 QUS952CL	23-7/8" x 11" x 7"	191 lbs
WR7-951CL	7	24 QUS951CL	23-7/8" x 8-1/4" x 9"	188 lbs
WR7-20-MIXCL	7	8 QUS950CL	23-7/8" x 8-1/4" x 7"	182 lbs
		4 QUS951CL	23-7/8" x 8-1/4" x 9"	
		3 QUS952CL	23-7/8" x 11" x 7"	
		3 QUS953CL	23-7/8" x 11" x 10"	
		2 QUS954CL	23-7/8" x 16-1/2" x 11"	
WR6-953CL	6	15 QUS953CL	23-7/8" x 11" x 10"	156 lbs
WR6-953954CL	6	9 QUS953CL	23-7/8" x 11" x 10"	159 lbs
		4 QUS954CL	23-7/8" x 16-1/2" x 11"	
WR6-954CL	6	10 QUS954CL	23-7/8" x 16-1/2" x 11"	164 lbs
24" x 42" x 74" System				
WR5-955CL	5	8 QUS955CL	23-7/8" x 18-1/4" x 12"	145 lbs

Clear-View HULK 24" Container Steel Shelving Systems - Complete Packages

MODEL NO.	NO. OF SHELVES	NO. OF BINS	BIN SIZE L" x W" x H"	SHIP WGT
24" x 36" x 75" Systems				
2475-950CL	8	28 QUS950CL	23-7/8" x 8-1/4" x 7"	213 lbs
2475-950952CL	8	12 QUS950CL	23-7/8" x 8-1/4" x 7"	205 lbs
		12 QUS952CL	23-7/8" x 11" x 7"	
2475-952CL	8	21 QUS952CL	23-7/8" x 11" x 7"	199 lbs
2475-951CL	7	24 QUS951CL	23-7/8" x 8-1/4" x 9"	195 lbs
2475-20MIXCL	7	8 QUS950CL	23-7/8" x 8-1/4" x 7"	189 lbs
		4 QUS951CL	23-7/8" x 8-1/4" x 9"	
		3 QUS952CL	23-7/8" x 11" x 7"	
		3 QUS953CL	23-7/8" x 11" x 10"	
		2 QUS954CL	23-7/8" x 16-1/2" x 11"	
2475-953CL	6	15 QUS953CL	23-7/8" x 11" x 10"	163 lbs
2475-953954CL	6	9 QUS953CL	23-7/8" x 11" x 10"	166 lbs
		4 QUS954CL	23-7/8" x 16-1/2" x 11"	
2475-954CL	6	10 QUS954CL	23-7/8" x 16-1/2" x 11"	171 lbs



MOBILIZE YOUR WIRE SHELVING

DB - Donut Bumper
Non-marking donut bumper used to protect walls and help cushion impact.

WR-00H (Mobile Kit)
Set of four swivel polyurethane 5" x 1-1/4" casters, two with brakes. Can be used with all systems shown. 1,200 lb. load capacity.



LOWEST PRICE GUARANTEED!



QGH700CL



QGH705MOBCL

Clear-View Giant Stack Containers



Multipurpose, wide open hopper front provides easy access for large part storage. Ideal for multiple applications in recycling, storing parts, tools and warehouse items. This bin will stack up to 6 bins high creating a sturdy, tall storage system. Injection molded from high density tri-clear polypropylene, easy to clean, resists rust and corrosion and impervious to most chemicals. Large label holder allows for quick identification. Optional clear window front increases storage capacity and allows for inspection of parts. Six 1/4" drill hole pattern on bottom of bin allows for easy hole insertion for drainage.

Available in: Clear

MODEL NO.	OUTSIDE DIMENSIONS L" x W" x H"	CTN QTY	CTN WGT	WINDOW	CTN QTY
QGH600CL	17-1/2" x 10-7/8" x 12-1/2"	4	12 lbs	WGH600	4
QGH700CL*	15-1/4" x 19-7/8" x 12-7/16"	3	13 lbs	WGH700	3
QGH800CL	17-1/2" x 16-1/2" x 12-1/2"	2	8 lbs	WGH800	2

* Optional label for QGH700 is available, LGH700 (3 per package)

COMPLETE PACKAGES WITH BINS



WR5-600CL



QUANTUM IS CLEARLY YOUR STORAGE SOLUTION



QSBU-700CL

Clear-View Mobile Giant Stack Containers



- Ideal for transport of heavy and bulky parts
- Container comes with 4 swivel, 3" casters, all with brakes, allowing for up to 250 lb. mobile load capacity
- Containers can stack with casters in place

Available in: Clear

MODEL NO.	OUTSIDE DIMENSIONS L" x W" x H"	CTN QTY	CTN WGT
QGH705MOBCL	15-1/4" x 19-7/8" x 12-7/16"	3	22 lbs
QGH805MOBCL	17-1/2" x 16-1/2" x 12-1/2"	2	17 lbs

* With casters, overall height for mobile container will be increased by 3"

Clear-View Giant Stack Wire Shelving Systems Complete Packages

MODEL NO.	NO. OF BINS	BIN SIZE L" x W" x H"	SHIP WGT
18" x 36" x 74" 5 Shelf Systems			
WR5-600CL	12 QGH600CL	17-1/2" x 10-7/8" x 12-1/2"	104 lbs
WR5-600800CL	6 QGH600CL	17-1/2" x 10-7/8" x 12-1/2"	103 lbs
	4 QGH800CL	17-1/2" x 16-1/2" x 12-1/2"	
WR5-800CL	8 QGH800CL	17-1/2" x 16-1/2" x 12-1/2"	102 lbs
18" x 42" x 74" 5 Shelf System			
WR5-700CL	8 QGH700CL	15-1/4" x 19-7/8" x 12-7/16"	98 lbs

Clear-View Giant Stack Steel Shelving Systems Complete Packages

Smooth powder coat finish and cross bracing for increased stability. 400 lb. capacity per shelf and over 21 cubic feet of storage space.

MODEL NO.	NO. OF BINS	BIN SIZE L" x W" x H"	SHIP WGT
18" x 36" x 75" 6 Shelf Systems			
QSBU-600CL	15 QGH600CL	17-1/2" x 10-7/8" x 12-1/2"	116 lbs
QSBU-600800CL	6 QGH600CL	17-1/2" x 10-7/8" x 12-1/2"	114 lbs
	6 QGH800CL	17-1/2" x 16-1/2" x 12-1/2"	
QSBU-800CL	10 QGH800CL	17-1/2" x 16-1/2" x 12-1/2"	113 lbs
18" x 42" x 75" 6 Shelf System			
QSBU-700CL	10 QGH700CL	15-1/4" x 19-7/8" x 12-7/16"	123 lbs



MOBILIZE YOUR WIRE SHELVING

DB - Donut Bumper

Non-marking donut bumper used to protect walls and help cushion impact.

WR-00H (Mobile Kit)

Set of four swivel polyurethane 5" x 1-1/4" casters, two with brakes. Can be used with all systems shown. 1,200 lb. load capacity.

Clear-View Economy 4" Shelf Bins



Quantum's tough, durable, high density Shelf Bins are the industry standard for quality. These durable tri-clear polypropylene bins feature a molded-in label holder, built-in rear hanglock which allows bins to tilt out for complete access when on shelving. A wide hopper front allows complete access to the contents of the bin. Edges are reinforced for added strength. They are designed for 12", 18" and 24" deep shelf units, racks or standard shelving. Bins are impervious to most chemicals. Dividers, bin cups and label holders available on [pg. 50](#).



QSB106CL

Available in: Clear

MODEL NO.	OUTSIDE DIMENSIONS L" x W" x H"	CTN QTY	CTN WGT
QSB100CL	11-5/8" x 2-3/4" x 4"	36	13 lbs
QSB101CL	11-5/8" x 4-1/8" x 4"	36	17 lbs
QSB102CL	11-5/8" x 6-5/8" x 4"	30	18 lbs
QSB107CL	11-5/8" x 8-3/8" x 4"	20	15 lbs
QSB109CL	11-5/8" x 11-1/8" x 4"	8	7 lbs
QSB103CL	17-7/8" x 4-1/8" x 4"	20	13 lbs
QSB104CL	17-7/8" x 6-5/8" x 4"	20	16 lbs
QSB108CL	17-7/8" x 8-3/8" x 4"	10	11 lbs
QSB110CL	17-7/8" x 11-1/8" x 4"	8	11 lbs
QSB105CL	23-5/8" x 4-1/8" x 4"	16	13 lbs
QSB106CL	23-5/8" x 6-5/8" x 4"	8	9 lbs
QSB114CL	23-5/8" x 8-3/8" x 4"	6	9 lbs
QSB116CL	23-5/8" x 11-1/8" x 4"	6	10 lbs

Individual labels are available for all Shelf Bins. For label Model No. substitute "L" for "Q" in bin Model No.

CTn Qty: 50 Individual Labels



MOBILIZE YOUR WIRE SHELVING

DB - Donut Bumper

Non-marking donut bumper used to protect walls and help cushion impact.

WR-00H (Mobile Kit)

Set of four swivel polyurethane 5" x 1-1/4" casters, two with brakes. Can be used with all systems shown. 1,200 lb. load capacity. *Mobile kits recommended only for shelves 18" and wider.

QUANTUM IS CLEARLY YOUR STORAGE SOLUTION

Clear-View Complete Bin Center

Complete bin systems are available with 4 different size bins on a 12"W x 36"L x 36"H unit. This all-purpose bin center is an economical high density storage system that provides easy visibility to stored contents.

MODEL NO.	NO. OF BINS	BIN SIZE L" x W" x H"	SHIP WGT
12" x 36" x 36" 6 Shelf Systems			
WR6-36-1236-101CL	40 QSB101CL	11-5/8" x 4-1/8" x 4"	63 lbs
WR6-36-1236-102CL	25 QSB102CL	11-5/8" x 6-5/8" x 4"	50 lbs
WR6-36-1236-107CL	20 QSB107CL	11-5/8" x 8-3/8" x 4"	62 lbs
WR6-36-1236-109CL	15 QSB109CL	11-5/8" x 11-1/8" x 4"	64 lbs

COMPLETE PACKAGES WITH BINS



WR12-107CL



WR6-36-1236-109CL

Clear-View Economy 4" Shelf Bin Wire Shelving Systems - Complete Packages

MODEL NO.	NO. OF BINS	BIN SIZE L" x W" x H"	SHIP WGT
12" x 36" x 74" 12 Shelf Systems			
WR12-101CL	88 QSB101CL	11-5/8" x 4-1/8" x 4"	120 lbs
WR12-102CL	55 QSB102CL	11-5/8" x 6-5/8" x 4"	116 lbs
WR12-107CL	44 QSB107CL	11-5/8" x 8-3/8" x 4"	117 lbs
WR12-109CL	33 QSB109CL	11-5/8" x 11-1/8" x 4"	119 lbs
18" x 36" x 74" 12 Shelf Systems			
WR12-103CL	88 QSB103CL	17-7/8" x 4-1/8" x 4"	176 lbs
WR12-104CL	55 QSB104CL	17-7/8" x 6-5/8" x 4"	165 lbs
WR12-108CL	44 QSB108CL	17-7/8" x 8-3/8" x 4"	170 lbs
WR12-110CL	33 QSB110CL	17-7/8" x 11-1/8" x 4"	168 lbs
24" x 36" x 74" 12 Shelf Systems			
WR12-105CL	88 QSB105CL	23-5/8" x 4-1/8" x 4"	228 lbs
WR12-106CL	55 QSB106CL	23-5/8" x 6-5/8" x 4"	218 lbs
WR12-114CL	44 QSB114CL	23-5/8" x 8-3/8" x 4"	222 lbs
WR12-116CL	33 QSB116CL	23-5/8" x 11-1/8" x 4"	206 lbs



LOWEST PRICE GUARANTEED!



SLOPED SHELVES EASY ACCESS



QPRHA-100CL

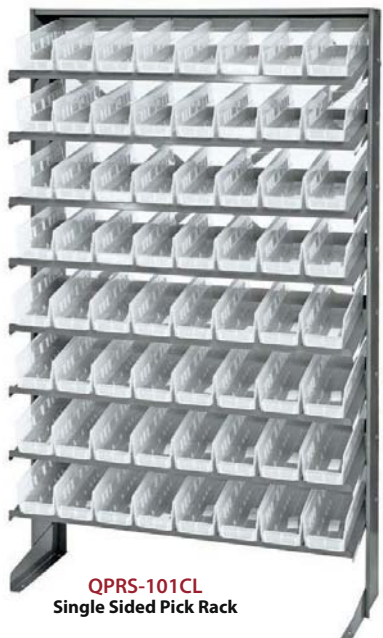

QPRS-101CL
Single Sided Pick Rack



QPRD-109CL
Double Sided Pick Rack

COMPLETE PACKAGES WITH BINS



1239-107CL

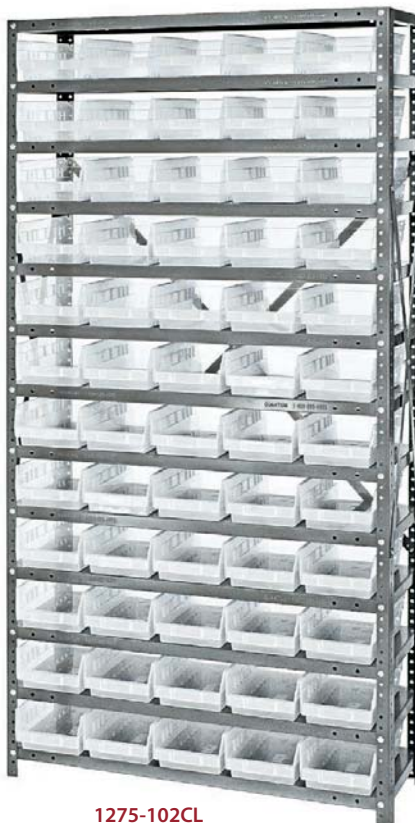

1275-102CL

Clear-View Economy 4" Shelf Bin Sloped Shelving Systems - Complete Packages

Pick Racks provide a convenient high density, easy access, sloped shelving system, available as bench units, single and double sided free standing and mobile units. Unit comes complete with Economical Shelf Bins. Sloped shelving unit keeps small and medium sized parts easily accessible. Open hopper front bins with label area, provide fast access to stored items. This all-in-one unit is easy to clean and will not rust or corrode. See chart for configurations. Additional 18" and 36" systems available on pg. 52. Bins are available in Clear.

MODEL NO.	NO. OF BINS	BIN SIZE L" x W" x H"	SHIP WGT
12-1/2" X 36" X 23" 3 Shelf Bench Rack Systems			
QPRHA-100CL	36 QSB100CL	11-5/8" x 2-3/4" x 4"	41 lbs
QPRHA-101CL	24 QSB101CL	11-5/8" x 4-1/8" x 4"	38 lbs
QPRHA-102CL	15 QSB102CL	11-5/8" x 6-5/8" x 4"	36 lbs
QPRHA-107CL	12 QSB107CL	11-5/8" x 8-3/8" x 4"	36 lbs
QPRHA-109CL	9 QSB109CL	11-5/8" x 11-1/8" x 4"	37 lbs
12" X 36" X 60" Single Sided 8 Shelf Rack Systems			
QPRS-100CL	96 QSB100CL	11-5/8" x 2-3/4" x 4"	99 lbs
QPRS-101CL	64 QSB101CL	11-5/8" x 4-1/8" x 4"	85 lbs
QPRS-102CL	40 QSB102CL	11-5/8" x 6-5/8" x 4"	80 lbs
QPRS-107CL	32 QSB107CL	11-5/8" x 8-3/8" x 4"	81 lbs
QPRS-109CL	24 QSB109CL	11-5/8" x 11-1/8" x 4"	83 lbs
24" X 36" X 60" Double Sided 16 Shelf Rack Systems			
QPRD-100CL	192 QSB100CL	11-5/8" x 2-3/4" x 4"	195 lbs
QPRD-101CL	128 QSB101CL	11-5/8" x 4-1/8" x 4"	169 lbs
QPRD-102CL	80 QSB102CL	11-5/8" x 6-5/8" x 4"	158 lbs
QPRD-107CL	64 QSB107CL	11-5/8" x 8-3/8" x 4"	160 lbs
QPRD-109CL	48 QSB109CL	11-5/8" x 11-1/8" x 4"	163 lbs
QDU-00	Mobile Kit - Mobilizes All Double Sided Systems		

*All Double Sided Units available as Mobile Units with addition of Mobile Kit Twelve QSB100CL, eight QSB101CL, five QSB102CL, four QSB107CL, three QSB109CL, six QUS230CL, three QUS235CL, and two QUS245CL fit across a standard 36" widepick rack shelf.

Clear-View Economy 4" Shelf Bin Steel Shelving Systems - Complete Packages

MODEL NO.	NO. OF BINS	BIN SIZE L" x W" x H"	SHIP WGT
12" x 36" x 75" 13 Shelf Systems			
1275-100CL	144 QSB100CL	11-5/8" x 2-3/4" x 4"	139 lbs
1275-101CL	96 QSB101CL	11-5/8" x 4-1/8" x 4"	117 lbs
1275-102CL	60 QSB102CL	11-5/8" x 6-5/8" x 4"	115 lbs
1275-107CL	48 QSB107CL	11-5/8" x 8-3/8" x 4"	120 lbs
1275-109CL	36 QSB109CL	11-5/8" x 11-1/8" x 4"	119 lbs
12" x 36" x 39" 7 Shelf Systems			
1239-100CL	72 QSB100CL	11-5/8" x 2-3/4" x 4"	75 lbs
1239-101CL	48 QSB101CL	11-5/8" x 4-1/8" x 4"	67 lbs
1239-102CL	30 QSB102CL	11-5/8" x 6-5/8" x 4"	63 lbs
1239-107CL	24 QSB107CL	11-5/8" x 8-3/8" x 4"	64 lbs
1239-109CL	18 QSB109CL	11-5/8" x 11-1/8" x 4"	65 lbs
18" x 36" x 75" 13 Shelf Systems			
1875-103CL	96 QSB103CL	17-7/8" x 4-1/8" x 4"	161 lbs
1875-104CL	60 QSB104CL	17-7/8" x 6-5/8" x 4"	155 lbs
1875-108CL	48 QSB108CL	17-7/8" x 8-3/8" x 4"	161 lbs
1875-110CL	36 QSB110CL	17-7/8" x 11-1/8" x 4"	158 lbs
18" x 36" x 39" 7 Shelf Systems			
1839-103CL	48 QSB103CL	17-7/8" x 4-1/8" x 4"	87 lbs
1839-104CL	30 QSB104CL	17-7/8" x 6-5/8" x 4"	84 lbs
1839-108CL	24 QSB108CL	17-7/8" x 8-3/8" x 4"	87 lbs
1839-110CL	18 QSB110CL	17-7/8" x 11-1/8" x 4"	86 lbs

Clear-View STORE-MORE 6" Shelf Bins



Maximize your storage space with durable, high density polypropylene bins. Quantum's STORE-MORE 6" H Shelf Bins are the industry standard for quality. These bins feature a molded-in label holder, built-in rear hang-lock which allows bins to tilt out for complete access when on shelving. A wide hopper front allows complete access to the contents of the bin. Edges are reinforced for added strength. They are designed for 12", 18" and 24" deep shelf units, racks or standard shelving. Optional dividers are a perfect solution to create a par level system. Bins are waterproof and corrosion-free. Dividers, bin cups and label holders available on **pg. 55**.



MOBILIZE YOUR WIRE SHELVING

DB - Donut Bumper
Non-marking donut bumper used to protect walls and help cushion impact.

WR-00H (Mobile Kit)
Set of four swivel polyurethane 5" x 1-1/4" casters, two with brakes. Can be used with all systems shown. 1,200 lb. load capacity. *Mobile kits recommended only for shelves 18" and wider.

QUANTUM IS CLEARLY YOUR STORAGE SOLUTION

COMPLETE PACKAGES WITH BINS



WR5-39-1236-209CL

WR9-202CL

Available in: Clear

MODEL NO.	OUTSIDE DIMENSIONS L" x W" x H"	CTN QTY	CTN WGT
QSB201CL	11-5/8" x 4-1/8" x 6"	36	19 lbs
QSB202CL	11-5/8" x 6-5/8" x 6"	30	20 lbs
QSB207CL	11-5/8" x 8-3/8" x 6"	20	17 lbs
QSB209CL	11-5/8" x 11-1/8" x 6"	8	9 lbs
QSB203CL	17-7/8" x 4-1/8" x 6"	20	15 lbs
QSB204CL	17-7/8" x 6-5/8" x 6"	20	18 lbs
QSB208CL	17-7/8" x 8-3/8" x 6"	10	13 lbs
QSB210CL	17-7/8" x 11-1/8" x 6"	8	13 lbs
QSB205CL	23-5/8" x 4-1/8" x 6"	16	15 lbs
QSB206CL	23-5/8" x 6-5/8" x 6"	8	11 lbs
QSB214CL	23-5/8" x 8-3/8" x 6"	6	11 lbs
QSB216CL	23-5/8" x 11-1/8" x 6"	6	12 lbs

Individual labels are available for all Shelf Bins. For label Model No. substitute "L" for "Q" in bin Model No. Ctn Qty: 50 Individual Labels

68% more storage capacity over standard 4" shelf bins, Quantum's **Store-More 6"** Shelf Bins are an industry first and now an industry standard.



Clear-View Complete Bin Center

Complete bin systems are available with 4 different size bins on a 12"W x 36"L x 39"H unit. This all-purpose bin center is an economical high density storage system that provides easy visibility to stored contents.

MODEL NO.	NO. OF BINS	BIN SIZE L" x W" x H"	SHIP WGT
12" x 36" x 39" 5 Shelf Systems			
WR5-39-1236-201CL	32 QSB201CL	11-5/8" x 4-1/8" x 6"	61 lbs
WR5-39-1236-202CL	20 QSB202CL	11-5/8" x 6-5/8" x 6"	57 lbs
WR5-39-1236-207CL	16 QSB207CL	11-5/8" x 8-3/8" x 6"	56 lbs
WR5-39-1236-209CL	12 QSB209CL	11-5/8" x 11-1/8" x 6"	55 lbs

Clear-View STORE-MORE 6" Shelf Bin Wire Shelving Systems - Complete Packages

MODEL NO.	NO. OF BINS	BIN SIZE L" x W" x H"	SHIP WGT
12" x 36" x 74" 9 Shelf Systems			
WR9-201CL	64 QSB201CL	11-5/8" x 4-1/8" x 6"	108 lbs
WR9-202CL	40 QSB202CL	11-5/8" x 6-5/8" x 6"	100 lbs
WR9-207CL	32 QSB207CL	11-5/8" x 8-3/8" x 6"	98 lbs
WR9-209CL	24 QSB209CL	11-5/8" x 11-1/8" x 6"	96 lbs
18" x 36" x 74" 9 Shelf Systems			
WR9-203CL	64 QSB203CL	17-7/8" x 4-1/8" x 6"	156 lbs
WR9-204CL	40 QSB204CL	17-7/8" x 6-5/8" x 6"	142 lbs
WR9-208CL	32 QSB208CL	17-7/8" x 8-3/8" x 6"	143 lbs
WR9-210CL	24 QSB210CL	17-7/8" x 11-1/8" x 6"	140 lbs
24" x 36" x 74" 9 Shelf Systems			
WR9-205CL	64 QSB205CL	23-5/8" x 4-1/8" x 6"	182 lbs
WR9-206CL	40 QSB206CL	23-5/8" x 6-5/8" x 6"	171 lbs
WR9-214CL	32 QSB214CL	23-5/8" x 8-3/8" x 6"	165 lbs
WR9-216CL	24 QSB216CL	23-5/8" x 11-1/8" x 6"	154 lbs



LOWEST PRICE GUARANTEED!



NEW

Clear-View STORE-MORE 6" Shelf Bin Sloped Steel Shelving Systems - Complete Packages

Pick Racks provide a convenient high density, easy access, sloped shelving system, available as bench units, single and double sided free standing and mobile units. Unit comes complete with Economical Shelf Bins. Sloped shelving unit keeps small and medium sized parts easily accessible. Open hopper front bins with label area, provide fast access to stored items. This all-in-one unit is easy to clean and will not rust or corrode. See chart for configurations. Additional 18" and 36" systems available on **pg. 57**. Bins are available in Clear.



QPRHA-201CL

SLOPED SHELVES EASY ACCESS



QPRS-202CL
Single Sided Pick Rack



QPRD-209CL
Double Sided Pick Rack

MODEL NO.	NO. OF BINS	BIN SIZE L" x W" x H"	SHIP WGT
12" x 36" x 26-1/2" 3 Shelf Bench Rack Systems			
QPRHA-201CL	24 QSB201CL	11-5/8" x 4-1/8" x 6"	40 lbs
QPRHA-202CL	15 QSB202CL	11-5/8" x 6-5/8" x 6"	37 lbs
QPRHA-207CL	12 QSB207CL	11-5/8" x 8-3/8" x 6"	36 lbs
QPRHA-209CL	9 QSB209CL	11-5/8" x 11-1/8" x 6"	35 lbs
12" x 36" x 63-1/2" Single Sided 8 Shelf Rack Systems			
QPRS-201CL	64 QSB201CL	11-5/8" x 4-1/8" x 6"	89 lbs
QPRS-202CL	40 QSB202CL	11-5/8" x 6-5/8" x 6"	81 lbs
QPRS-207CL	32 QSB207CL	11-5/8" x 8-3/8" x 6"	79 lbs
QPRS-209CL	24 QSB209CL	11-5/8" x 11-1/8" x 6"	77 lbs
24" x 36" x 63-1/2" Double Sided 16 Shelf Rack Systems			
QPRD-201CL	128 QSB201CL	11-5/8" x 4-1/8" x 6"	178 lbs
QPRD-202CL	80 QSB202CL	11-5/8" x 6-5/8" x 6"	162 lbs
QPRD-207CL	64 QSB207CL	11-5/8" x 8-3/8" x 6"	158 lbs
QPRD-209CL	48 QSB209CL	11-5/8" x 11-1/8" x 6"	154 lbs
QDU-00	Mobile Kit - Mobilizes All Double Sided Systems		

*All Double Sided Units available as Mobile Units with addition of Mobile Kit eight QSB201CL, five QSB202CL, four QSB207CL, three QSB209CL, six QUS230CL, three QUS235CL, and two QUS245CL fit across a standard 36" widepick rack shelf.

COMPLETE PACKAGES WITH BINS

Clear-View STORE-MORE 6" Shelf Bin Steel Shelving Systems - Complete Packages

MODEL NO.	NO. OF BINS	BIN SIZE L" x W" x H"	SHIP WGT
12" x 36" x 75" 10 Shelf Systems			
1275-201CL	72 QSB201CL	11-5/8" x 4-1/8" x 6"	111 lbs
1275-202CL	45 QSB202CL	11-5/8" x 6-5/8" x 6"	103 lbs
1275-207CL	36 QSB207CL	11-5/8" x 8-3/8" x 6"	100 lbs
1275-209CL	27 QSB209CL	11-5/8" x 11-1/8" x 6"	98 lbs
12" x 36" x 39" 5 Shelf Systems			
1239-201CL	32 QSB201CL	11-5/8" x 4-1/8" x 6"	56 lbs
1239-202CL	20 QSB202CL	11-5/8" x 6-5/8" x 6"	52 lbs
1239-207CL	16 QSB207CL	11-5/8" x 8-3/8" x 6"	51 lbs
1239-209CL	12 QSB209CL	11-5/8" x 11-1/8" x 6"	50 lbs
18" x 36" x 75" 10 Shelf Systems			
1875-203CL	72 QSB203CL	17-7/8" x 4-1/8" x 6"	156 lbs
1875-204CL	45 QSB204CL	17-7/8" x 6-5/8" x 6"	141 lbs
1875-208CL	36 QSB208CL	17-7/8" x 8-3/8" x 6"	142 lbs
1875-210CL	27 QSB210CL	17-7/8" x 11-1/8" x 6"	139 lbs
18" x 36" x 39" 5 Shelf Systems			
1839-203CL	32 QSB203CL	17-7/8" x 4-1/8" x 6"	77 lbs
1839-204CL	20 QSB204CL	17-7/8" x 6-5/8" x 6"	70 lbs
1839-208CL	16 QSB208CL	17-7/8" x 8-3/8" x 6"	71 lbs
1839-210CL	12 QSB210CL	17-7/8" x 11-1/8" x 6"	69 lbs

QUANTUM IS CLEARLY YOUR STORAGE SOLUTION



1239-201CL



1275-202CL

QUANTUM IS CLEARLY YOUR STORAGE SOLUTION

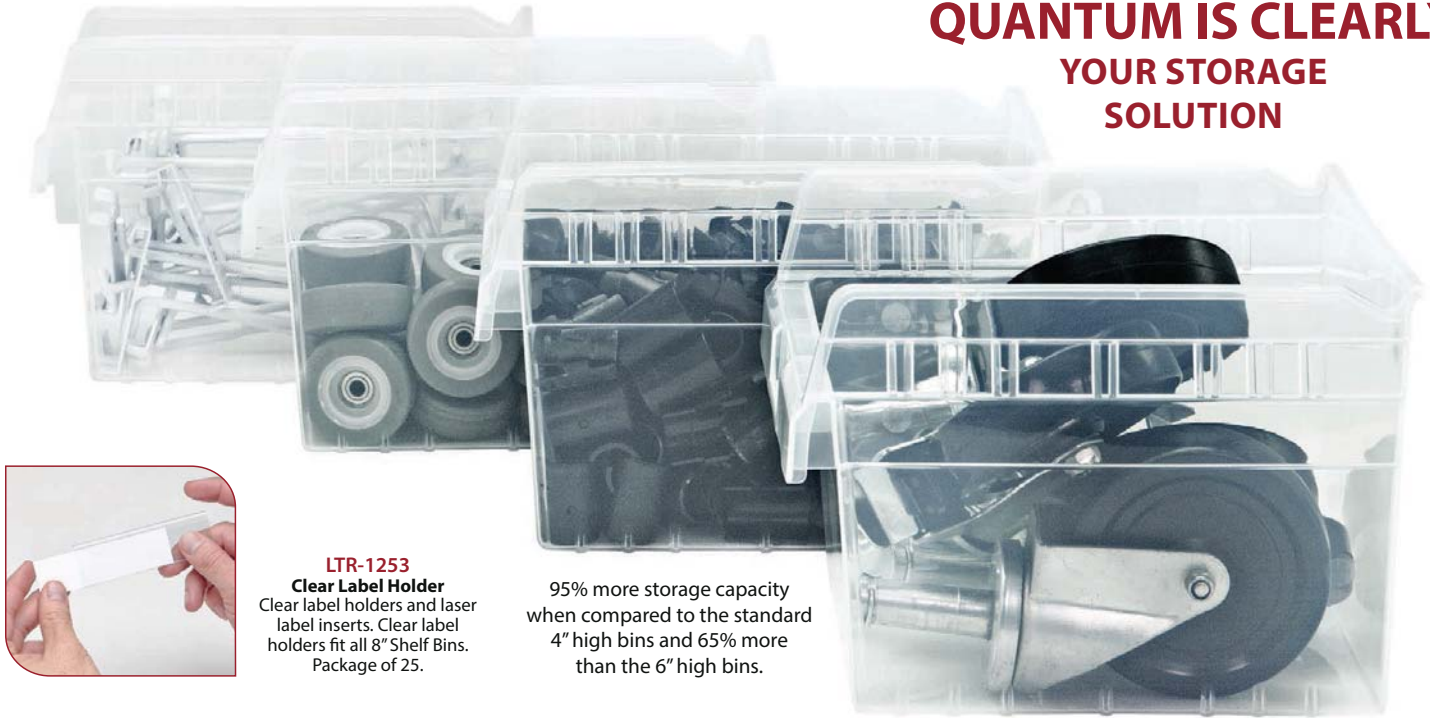

LTR-1253 Clear Label Holder
Clear label holders and laser label inserts. Clear label holders fit all 8" Shelf Bins. Package of 25.

95% more storage capacity when compared to the standard 4" high bins and 65% more than the 6" high bins.

Extended Label Holders *simplify identification!*

Optional extended label holders are designed for larger bar code scanning. Label holders fit all 8" Shelf Bins.

MODEL NO.	DESCRIPTION	DIMENSIONS W" x H"	CTN QTY
ELH410	10° Angle	4" x 2-1/4"	24
ELH445	45° Angle	4" x 2-1/4"	24

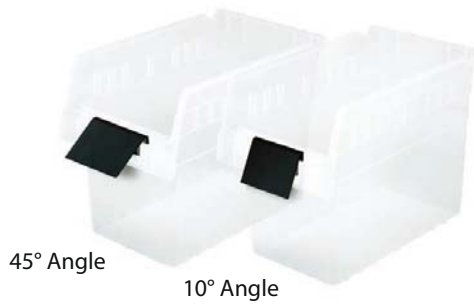

Divider Label Tab

Divider Label Tabs attach to existing dividers to improve the visibility of bin labels and scanning of barcodes. Package of 6.

Clear-View STORE-MAX 8" Shelf Bins



Our new 8" high bins offer 95% more storage capacity when compared to the standard 4" high bins and 65% more than the 6" high bins. The new STORE-MAX 8"H bins will truly maximize and organize your space. Manufactured from high density polypropylene, STORE-MAX 8"H Shelf Bins are the industry standard for quality. These bins feature a molded-in label holder on a wide hopper front allowing complete access to the contents of the bin. Edges are reinforced for added strength. They are designed for 12", 18" and 24" deep shelf units, racks or standard shelving. Optional dividers are a perfect accessory to subdivide and keep parts separated as needed.

Available in: Clear

MODEL NO.	OUTSIDE DIMENSIONS L" x W" x H"	INSIDE DIMENSIONS L" x W" x H"	CTN QTY	CTN WGT	DIVIDER	CTN QTY	NO. OF BIN CUPS PER BIN
							QBC111 QBC112
QSB801CL	11-5/8" x 4-3/8" x 8"	10-1/6" x 3" x 8"	36	27 lbs	DSB801	50	6 2
QSB802CL	11-5/8" x 6-5/8" x 8"	10-1/6" x 5-1/2" x 8"	30	26 lbs	DSB802	50	9 4
QSB807CL	11-5/8" x 8-3/8" x 8"	10-1/6" x 7-1/8" x 8"	20	21 lbs	DSB807	50	12 4
QSB809CL	11-5/8" x 11-1/8" x 8"	10-1/6" x 10" x 8"	8	11 lbs	DSB809	50	18 6
QSB803CL	17-7/8" x 4-3/8" x 8"	16-1/2" x 3" x 8"	20	22 lbs	DSB803	50	9 3
QSB804CL	17-7/8" x 6-5/8" x 8"	16-1/2" x 5-1/2" x 8"	20	26 lbs	DSB804	50	15 6
QSB808CL	17-7/8" x 8-3/8" x 8"	16-1/2" x 7-1/8" x 8"	10	15 lbs	DSB808	50	19 6
QSB810CL	17-7/8" x 11-1/8" x 8"	16-1/2" x 10" x 8"	8	17 lbs	DSB810	50	29 8
QSB805CL	23-5/8" x 4-3/8" x 8"	22-1/8" x 3" x 8"	16	24 lbs	DSB805	50	13 4
QSB806CL	23-5/8" x 6-5/8" x 8"	22-1/8" x 5-1/2" x 8"	8	13 lbs	DSB806	50	21 8
QSB814CL	23-5/8" x 8-3/8" x 8"	22-1/8" x 7-1/8" x 8"	6	12 lbs	DSB814	50	24 8
QSB816CL	23-5/8" x 11-1/8" x 8"	22-1/8" x 10" x 8"	6	14 lbs	DSB816	50	35 16

Individual labels are available for all STORE-MAX 8" Shelf Bins. For label Model No. substitute "L" for "Q" in bin Model No.

Ctn Qty: 50 Individual Labels



Dividers and Bin Cups

Optional black dividers fit snugly, horizontally across bins to create compartments. Each bin accepts up to 7 dividers. Bin cups have a raised, slotted label holder for easy parts identification. The entire bin cup may be removed for easy part retrieval. Available in 2 sizes and 2 colors.

Available in: Blue Yellow

MODEL NO.	OUTSIDE DIMENSIONS L" x W" x H"	CTN QTY	CTN WGT
QBC111	3-1/4" x 1-3/4" x 3"	48	4 lbs
QBC112	5-1/8" x 2-3/4" x 3"	48	7 lbs



LOWEST PRICE GUARANTEED!

COMPLETE PACKAGES WITH BINS



MOBILIZE YOUR WIRE SHELVING

DB - Donut Bumper

Non-marking donut bumper used to protect walls and help cushion impact.

WR-00H (Mobile Kit)

Set of four swivel polyurethane 5" x 1-1/4" casters, two with brakes. Can be used with all units shown. 1,200 lb. load capacity. *Mobile kits recommended only for shelves 18" and wider.



WR4-39-1236-802CL

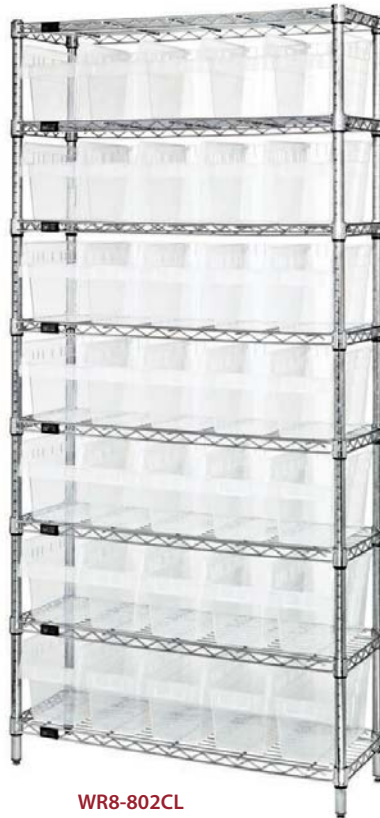

WR8-802CL

QUANTUM IS CLEARLY YOUR STORAGE SOLUTION



1239-SB807CL

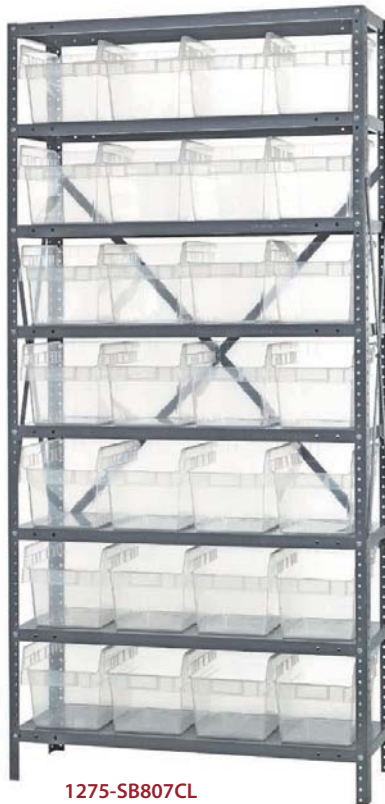

1275-SB807CL

NEW

Clear-View Complete Bin Center

Complete bin systems are available with 4 different size bins on a 12"W x 36"L x 39"H unit. This all-purpose bin center is an economical high density storage system that provides easy visibility to stored contents. Bins are available in Clear.

MODEL NO.	NO. OF BINS	BIN SIZE L" x W" x H"	SHIP WGT
12" x 36" x 39" 4 Shelf Systems			
WR4-39-1236-801CL	24 QSB801CL	11-5/8" x 4-3/8" x 8"	61 lbs
WR4-39-1236-802CL	15 QSB802CL	11-5/8" x 6-5/8" x 8"	57 lbs
WR4-39-1236-807CL	12 QSB807CL	11-5/8" x 8-3/8" x 8"	56 lbs
WR4-39-1236-809CL	9 QSB809CL	11-5/8" x 11-1/8" x 8"	55 lbs

Clear-View STORE-MAX 8" Shelf Bin Wire Shelving Systems - Complete Packages

MODEL NO.	NO. OF BINS	BIN SIZE L" x W" x H"	SHIP WGT
12" x 36" x 74" 8 Shelf Systems			
WR8-801CL	56 QSB801CL	11-5/8" x 4-3/8" x 8"	108 lbs
WR8-802CL	35 QSB802CL	11-5/8" x 6-5/8" x 8"	100 lbs
WR8-807CL	28 QSB807CL	11-5/8" x 8-3/8" x 8"	98 lbs
WR8-809CL	21 QSB809CL	11-5/8" x 11-1/8" x 8"	96 lbs
18" x 36" x 74" 8 Shelf Systems			
WR8-803CL	56 QSB803CL	17-7/8" x 4-3/8" x 8"	156 lbs
WR8-804CL	35 QSB804CL	17-7/8" x 6-5/8" x 8"	142 lbs
WR8-808CL	28 QSB808CL	17-7/8" x 8-3/8" x 8"	143 lbs
WR8-810CL	21 QSB810CL	17-7/8" x 11-1/8" x 8"	140 lbs
24" x 36" x 74" 8 Shelf Systems			
WR8-805CL	56 QSB805CL	23-5/8" x 4-3/8" x 8"	182 lbs
WR8-806CL	35 QSB806CL	23-5/8" x 6-5/8" x 8"	171 lbs
WR8-814CL	28 QSB814CL	23-5/8" x 8-3/8" x 8"	165 lbs
WR8-816CL	21 QSB816CL	23-5/8" x 11-1/8" x 8"	154 lbs

Clear-View STORE-MAX 8" Shelf Bin Steel Shelving Systems - Complete Packages

MODEL NO.	NO. OF BINS	BIN SIZE L" x W" x H"	SHIP WGT
12" x 36" x 75" 8 Shelf Systems			
1275-SB801CL	56 QSB801CL	11-5/8" x 4-3/8" x 8"	111 lbs
1275-SB802CL	35 QSB802CL	11-5/8" x 6-5/8" x 8"	103 lbs
1275-SB807CL	28 QSB807CL	11-5/8" x 8-3/8" x 8"	100 lbs
1275-SB809CL	21 QSB809CL	11-5/8" x 11-1/8" x 8"	98 lbs
12" x 36" x 39" 4 Shelf Systems			
1239-SB801CL	24 QSB801CL	11-5/8" x 4-3/8" x 8"	56 lbs
1239-SB802CL	15 QSB802CL	11-5/8" x 6-5/8" x 8"	52 lbs
1239-SB807CL	12 QSB807CL	11-5/8" x 8-3/8" x 8"	51 lbs
1239-SB809CL	9 QSB809CL	11-5/8" x 11-1/8" x 8"	50 lbs
16" x 36" x 75" 8 Shelf Systems			
1875-SB803CL	56 QSB803CL	17-7/8" x 4-3/8" x 8"	156 lbs
1875-SB804CL	35 QSB804CL	17-7/8" x 6-5/8" x 8"	141 lbs
1875-SB808CL	28 QSB808CL	17-7/8" x 8-3/8" x 8"	142 lbs
1875-SB810CL	21 QSB810CL	17-7/8" x 11-1/8" x 8"	139 lbs
18" x 36" x 39" 4 Shelf Systems			
1839-SB803CL	24 QSB803CL	17-7/8" x 4-3/8" x 8"	77 lbs
1839-SB804CL	15 QSB804CL	17-7/8" x 6-5/8" x 8"	70 lbs
1839-SB808CL	12 QSB808CL	17-7/8" x 8-3/8" x 8"	71 lbs
1839-SB810CL	9 QSB810CL	17-7/8" x 11-1/8" x 8"	69 lbs



Clear-View Dividable Grid Containers



Heavy-duty Dividable Grid Containers can be used for storage, kitting and distribution applications. These containers offer the safest and most efficient method for compartmentalizing and protecting small to medium sized items. Dividers allow you to customize the container's interior to meet your exact needs. Dividers: Gray. Containers and covers are available in Clear.

Available in: Clear

MODEL NO.	OUTSIDE DIMENSIONS L" x W" x H"	INSIDE DIMENSIONS L" x W" x H"	CTN QTY	CTN WGT
DG91035CL	10-7/8" x 8-1/4" x 3-1/2"	9-3/16" x 6-9/16" x 3"	20	24 lbs
DG91050CL	10-7/8" x 8-1/4" x 5"	9-3/16" x 6-9/16" x 4-1/2"	20	32 lbs
DG92035CL	16-1/2" x 10-7/8" x 3-1/2"	14-7/8" x 9-1/4" x 3"	12	23 lbs
DG92060CL	16-1/2" x 10-7/8" x 6"	14-7/8" x 9-1/4" x 5-1/2"	8	20 lbs
DG92080CL	16-1/2" x 10-7/8" x 8"	14-7/8" x 9-1/4" x 7-1/2"	8	27 lbs
DG93030CL	22-1/2" x 17-1/2" x 3"	20-5/8" x 15-5/8" x 2-1/2"	6	20 lbs
DG93060CL	22-1/2" x 17-1/2" x 6"	20-5/8" x 15-5/8" x 5-1/2"	3	16 lbs
DG93080CL	22-1/2" x 17-1/2" x 8"	20-5/8" x 15-5/8" x 7-1/2"	3	19 lbs
DG93120CL	22-1/2" x 17-1/2" x 12"	20-5/8" x 15-5/8" x 11-1/2"	3	23 lbs



Clear Dividable Grid Container
Shown with optional cover
see **pg. 67**
(Sold separately)



Clear Dividable Grid Container
Shown with optional dividers
see **pg. 67**
(Sold separately)



WR7-92080CL

**COMPLETE
PACKAGES
WITH BINS**



MOBILIZE YOUR WIRE SHELVING

DB - Donut Bumper

Non-marking donut bumper used to protect walls and help cushion impact.

WR-00H (Mobile Kit)

Set of four swivel polyurethane 5" x 1-1/4" casters, two with brakes. Can be used with all units shown. 1,200 lb. load capacity.

**Clear-View Dividable Grid Container Wire Shelving Systems
Complete Packages**

Same durable chrome wire shelving combined with Quantum's Clear-View Dividable Grid Containers. These containers allow for multiple compartment configurations within each bin. Offering four different packages, these systems are ideal for small, medium and large parts storage. System may be made mobile with the addition of the **WR-00H** mobile kit. See **pg. 67** for additional information and to order optional accessories.

MODEL NO.	NO. OF SHELVES	NO. OF BINS	BIN DIMENSIONS L" x W" x H"	SHIP WGT
18" x 48" x 74" Wire Shelving Systems				
WR9-92060CL	9	36 DG92060CL	16-1/2" x 10-7/8" x 6"	210 lbs
WR7-92080CL	7	24 DG92080CL	16-1/2" x 10-7/8" x 8"	174 lbs
24" x 60" x 63" Wire Shelving Systems				
WR12-93030CL	12	36 DG93030CL	22-1/2" x 17-1/2" x 3"	274 lbs
24" x 60" x 74" Wire Shelving Systems				
WR9-93060CL	9	24 DG93060CL	22-1/2" x 17-1/2" x 6"	254 lbs

Bin Carts

Modular carts are the ultimate work-in-process and transport cart. Dividable grids slide easily in and out and with their ability to be divided into multiple compartments with long and short dividers, see **pg. 67** for dividers and label holders. Double and Triple Bay Carts are also available, see **pg. 137**. Dividable grids are available in Clear. **Cart Finish:** Chrome

MODEL NO.	NO. OF BINS	BIN DIMENSIONS L" x W" x H"	SHIP WGT
21"W x 24"L x 45"H Bin Cart with Dividable Grid Containers			
BC212434M1CL	4 DG93060CL	22-1/2" x 17-1/2" x 6"	58 lbs
BC212439M2CL	7 DG93030CL	22-1/2" x 17-1/2" x 3"	79 lbs
21"W x 24"L x 69"H Bin Cart with Dividable Grid Containers			
BC212469M1CL	7 DG93060CL	22-1/2" x 17-1/2" x 6"	107 lbs
BC212469M2CL	11 DG93030CL	22-1/2" x 17-1/2" x 3"	111 lbs
21"W x 24"L x 45"H Bin Cart with No Dividable Grid Containers			
BC212439M4	No containers (includes slides for 4 bin levels)		46 lbs
BC212439M7	No containers (includes slides for 7 bin levels)		55 lbs
21"W x 24"L x 69"H Bin Cart with No Dividable Grid Containers			
BC212469M	No containers (includes slides for 7 bin levels)		63 lbs
BC212469M11	No containers (includes slides for 11 bin levels)		75 lbs
One Pair - 24" Wire Bin Slides			
WR-S24W	-	-	3 lbs

**QUANTUM IS CLEARLY
YOUR STORAGE SOLUTION**



BC212434M1CL



Clear Dust Cover Acrylic Inlays

Clear Acrylic Dust Cover Inlays keep stored items visible while protecting against airborne dust and other contaminants. Cover lays inside on recessed rim of container.

MODEL NO.	FITS BIN MODEL NO.	CTN QTY
DDC91000CL	DG91035CL, DG91050CL	10
DDC92000CL	DG92035CL, DG92060CL, DG92080CL	4
DDC93000CL	DG93030CL, DG93060CL, DG93080CL, DG93120CL	3



Bin, Tote and Container Labels



Labels facilitate parts identification and bar coding of the bin contents. Label sizes and availability vary per product. Correct labeling option(s) are specified alongside products details shown throughout the catalog.

INSERTS INCLUDED

Clear Label Holders and Inserts

Clear label holders easily slide into molded-in label slot on bin to protect label. Laser and inkjet compatible inserts come in 8-1/2" x 11" perforated sheets. Each package includes 25 clear holders and corresponding printer friendly sheet labels.

5 MODELS AVAILABLE



LTR-0813, LTR-1253, LTR-1300, LTR-1754, LTR-2400

Adhesive Label Holders and Inserts

Adhesive label holders are designed to work with bins without molded-in label slots. These label holders will attach securely to a flat surface. Laser and inkjet compatible inserts come in 8-1/2" x 11" perforated sheets. Each package includes 24 adhesive holders and corresponding printer friendly sheet labels.



AL-23



AL-35

Individual Labels / Inserts

Individual label inserts are precut to slide into molded-in label slots on bin fronts. Package of 50 individual cut labels (not intended for printer use).



INSERTS NOT INCLUDED

Label Holders for Dividable Grid Containers

Label holders are available for standard and conductive dividable grid containers. Three sizes to choose from (2" x 8", 3" x 5" and 5" x 8"). Package of 6.



CLEAR LABEL HOLDER



CONDUCTIVE LABEL HOLDER

Clear Hanging Label Holder

3" x 5" clear hanging label holder securely attaches to all sizes of stack and nest totes and cross stack tubs. Label holder can be used on totes and tubs with or without lids for easy part identification. Package of 6.



FITS ALL CROSS STACK TUBS



FITS ALL stack and nest TOTES

Extended Label Holders

Extended label holders are designed to slide into the molded-on label slot of bins to allow for larger bar code scanning. Provides a 4" x 2-1/4" flat angled surface. Package of 24.

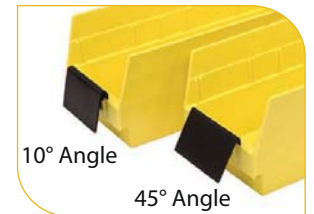

ELH410 & ELH445

Divider Label Tab



Divider label tabs attach directly to dividers to improve the visibility of bins labels and scanning of barcodes. Multiple tabs within the same bin can be offset to easily identify all compartments. Package of 6.



DLT-6



10 SIZES AND 5 COLORS AVAILABLE



STACKABLE SHELF BIN
Shown with optional Divider and **DLT-6** Divider Label Tabs attach to existing dividers to improve the visibility of bin labels and scanning of barcodes. Package of 6. (Dividers and Label Tabs sold separately)

Stackable Shelf Bins



Quantum's exclusive Stackable Shelf Bins are an industry first and are ideal for medium size and large or heavy item storage. These strong, durable polypropylene bins are available in 4 lengths and 3 widths. 12", 14" and 18" deep bins have a built in rear hanger which allows bin to hang from lowered panels and rails. Bins have a raised front opening when compared to any like product allowing you to truly maximize the complete bin's storage capacity. Optional cross dividers allow flexibility and keep parts organized. Waterproof bins resist rust and corrosion. Large molded in front label slots for ID labels. Autoclavable up to 250°F and resistant to extreme cold. Available in 5 colors.

Available in: ● Blue ● Gray ● Ivory ● Black ● Orange

MODEL NO.	OUTSIDE DIMENSIONS L" x W" x H"	INSIDE DIMENSIONS L" x W" x H"	CTN QTY	CTN WGT	DIVIDER	CTN QTY	CTN WGT	CLEAR LABEL HOLDER & INSERT
SSB423	12" x 8-1/4" x 7"	11-1/2" x 7-3/8" x 6-1/2"	6	9 lbs	DSS403	6	1 lb	LTR-2400
SSB425	12" x 11" x 7"	11-1/2" x 10-1/8" x 6-1/2"	6	11 lbs	DSS405	6	2 lbs	LTR-2400
SSB441	14" x 6" x 7"	13-1/2" x 5-3/8" x 6-1/2"	6	8 lbs	DSS401	6	1 lb	LTR-2400
SSB443	14" x 8-1/4" x 7"	13-1/2" x 7-3/8" x 6-1/2"	12	18 lbs	DSS403	6	1 lb	LTR-2400
SSB445	14" x 11" x 7"	13-1/2" x 10-1/8" x 6-1/2"	6	12 lbs	DSS405	6	2 lbs	LTR-2400
SSB461	18" x 6" x 7"	17-1/2" x 5-3/8" x 6-1/2"	6	11 lbs	DSS401	6	1 lb	LTR-2400
SSB463	18" x 8-1/4" x 7"	17-1/2" x 7-3/8" x 6-1/2"	6	12 lbs	DSS403	6	1 lb	LTR-2400
SSB465	18" x 11" x 7"	17-1/2" x 10-1/8" x 6-1/2"	6	16 lbs	DSS405	6	2 lbs	LTR-2400
SSB483	20-1/2" x 8-1/4" x 7"	20" x 7-3/8" x 6-1/2"	6	14 lbs	DSS403	6	1 lb	LTR-2400
SSB485	20-1/2" x 11" x 7"	20" x 10-1/8" x 6-1/2"	6	18 lbs	DSS405	6	2 lbs	LTR-2400



LTR-2400
Clear Label Holder & Insert
Package of 25.

PERFORMANCE FEATURES:

- Available in 10 sizes
- Standard colors: Blue, Gray, Ivory, Black and Orange
(additional colors available on request, subject to up charge and minimum runs)
- Bins are made from heavy-duty, virgin, high density FDA approved polypropylene
- Large label slot provide easy label insertion and parts identification
- Extra wide stacking ledge assures stability for high stacking
- Reinforced design adds strength and prevents spreading
- Will not rust or corrode, unaffected by weak acids and alkalis, and are waterproof
- Autoclavable up to 250°F

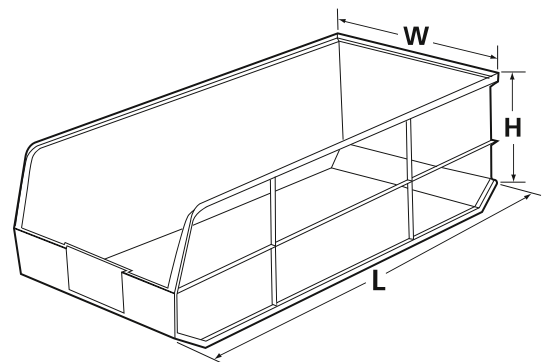

Bin Dimensions Guide
L (length) W (width) H (height)



LOWEST PRICE GUARANTEED!



2475-485
24"D x 36"W x 75"H
8 shelves and 21 SSB485
20-1/2"L x 11"W x 7"H bins

STACKABLE SHELF BIN

Stackable Shelf Bin Steel Shelving Systems - Complete Packages

NEW

Available in: ● Blue ● Gray ● Ivory ● Black ● Orange

MODEL NO.	OUTSIDE DIMENSIONS D" x W" x H"	NO. OF SHELVES	NO. OF BINS	BIN DIMENSIONS L" x W" x H"	SHIP WGT
1275-423	12" x 36" x 75"	8	28 SSB423	12" x 8-1/4" x 7"	129 lbs
1275-425	12" x 36" x 75"	8	21 SSB425	12" x 11" x 7"	126 lbs
1275-441	12" x 36" x 75"	8	35 SSB441	14" x 6" x 7"	134 lbs
1275-443	12" x 36" x 75"	8	28 SSB443	14" x 8-1/4" x 7"	129 lbs
1275-445	12" x 36" x 75"	8	21 SSB445	14" x 11" x 7"	129 lbs
1875-461	18" x 36" x 75"	8	35 SSB461	18" x 6" x 7"	173 lbs
1875-463	18" x 36" x 75"	8	28 SSB463	18" x 8-1/4" x 7"	165 lbs
1875-465	18" x 36" x 75"	8	21 SSB465	18" x 11" x 7"	165 lbs
2475-483	24" x 36" x 75"	8	28 SSB483	20-1/2" x 8-1/4" x 7"	197 lbs
2475-483485	24" x 36" x 75"	8	12 SSB483	20-1/2" x 8-1/4" x 7"	195 lbs
			12 SSB485	20-1/2" x 11" x 7"	
2475-485	24" x 36" x 75"	8	21 SSB485	20-1/2" x 11" x 7"	194 lbs

COMPLETE PACKAGES WITH BINS



MOBILIZE YOUR WIRE SHELVING

DB - Donut Bumper
Non-marking donut bumper used to protect walls and help cushion impact.

WR-00H (Mobile Kit)*
Set of four swivel polyurethane 5" x 1-1/4" casters, two with brakes. Can be used with all units shown. 1,200 lb. load capacity. *Mobile kits recommended only for shelves 18" and wider.



WR8-463
18"W x 36"L x 74"H
8 shelves and 28 SSB463
18"L x 8-1/4"W x 7"H bins

Stackable Shelf Bin Wire Shelving Systems - Complete Packages

NEW

Available in: ● Blue ● Gray ● Ivory ● Black ● Orange

MODEL NO.	OUTSIDE DIMENSIONS W" x L" x H"	NO. OF SHELVES	NO. OF BINS	BIN DIMENSIONS L" x W" x H"	SHIP WGT
WR8-423	12" x 36" x 74"	8	28 SSB423	12" x 8-1/4" x 7"	114 lbs
WR8-425	12" x 36" x 74"	8	21 SSB425	12" x 11" x 7"	107 lbs
WR8-441	14" x 36" x 74"	8	35 SSB441	14" x 6" x 7"	136 lbs
WR8-443	14" x 36" x 74"	8	28 SSB443	14" x 8-1/4" x 7"	129 lbs
WR8-445	14" x 36" x 74"	8	21 SSB445	14" x 11" x 7"	122 lbs
WR8-461	18" x 36" x 74"	8	35 SSB461	18" x 6" x 7"	190 lbs
WR8-463	18" x 36" x 74"	8	28 SSB463	18" x 8-1/4" x 7"	180 lbs
WR8-465	18" x 36" x 74"	8	21 SSB465	18" x 11" x 7"	184 lbs
WR8-483	21" x 36" x 74"	8	28 SSB483	20-1/2" x 8-1/4" x 7"	198 lbs
WR8-483485	21" x 36" x 74"	8	12 SSB483	20-1/2" x 8-1/4" x 7"	199 lbs
			12 SSB485	20-1/2" x 11" x 7"	
WR8-485	21" x 36" x 74"	8	21 SSB485	20-1/2" x 11" x 7"	198 lbs

8 SIZES AND 4 COLORS AVAILABLE



AVAILABLE on pg. 24



QUS952

QUS951

QUS954

QUS955

QUS953

QUS950

HULK containers



POLYMER MOBILE DOLLY
DLY-3018 Dolly with Padded Rubber Trim, available in Blue. 1,000 lb. capacity. Dimensions 30" L x 18" W

ATTACHED PULL RING
allows dolly to be pulled with ease



AL-23
2" x 3-1/2"
Adhesive clear label holder & inserts. Package of 24 (Sold separately)

HULK CONTAINER
Shown with optional divider, window front, adhesive label holder and insert



MOBILE HULK CONTAINER
Ideal for transport of heavy and bulky parts. Bin comes with 4 swivel, 3" casters, all with brakes, allowing up to 250 lb. mobile load capacity

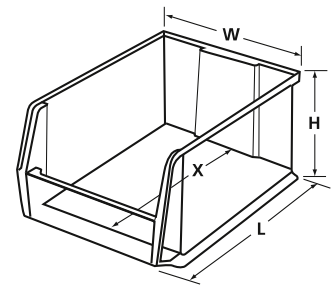

Bin Dimensions Guide
L (length) W (width)
H (height) X (inside length)

HULK 24" Containers



Organize and store your large and bulky items with these strong injection molded polypropylene, stackable containers. These extra large stacking containers offer a generous 2 feet in length to store your larger items. These huge stack bins are ideal for heavy-duty, extra deep shelving and are available in a variety of widths and heights. Heavy-duty front, back and side grips allow for easy handling. Optional clear styrene plastic window increases bin capacity and provides a quick view of the bin contents. Optional dividers maximize flexibility and keep contents organized. Wide stacking ledge and anti-slide lock keep stacked bins steady and prevent forward shifting. Waterproof bins are corrosion free. Bins are autoclavable up to 250°F and are resistant to extreme cold. Available in 4 colors. See **pg. 24** to order Clear bins.

Available in: ● Blue ● Red ● Yellow ● Clear

MODEL NO.	OUTSIDE DIMENSIONS L" x W" x H"	INSIDE DIMENSIONS L" x W" x H"	X"	CTN QTY	CTN WGT	CLEAR WINDOW	CTN QTY	DIVIDER	CTN QTY	CLEAR LABEL HOLDER & INSERT	CTN QTY
QUS950	23-7/8" x 8-1/4" x 7"	21-7/8" x 6-1/4" x 6-5/8"	19"	6	18 lbs	WUS950/970	6	DUS950	6	-	-
QUS951	23-7/8" x 8-1/4" x 9"	21-7/8" x 6-1/4" x 8-3/4"	18-3/4"	6	21 lbs	WUS951	6	DUS951	6	-	-
QUS952	23-7/8" x 11" x 7"	21-7/8" x 9" x 6-7/8"	19"	4	14 lbs	WUS952	4	DUS952	6	-	-
QUS953	23-7/8" x 11" x 10"	21-1/2" x 8-7/8" x 9-3/4"	18-3/4"	4	18 lbs	WUS953/973	4	DUS953	6	-	-
QUS954	23-7/8" x 16-1/2" x 11"	21-7/8" x 14-1/4" x 10-3/4"	18-3/4"	1	7 lbs	WUS954/974	1	DUS954	6	AL-23	24
QUS964MOB	23-7/8" x 16-1/2" x 11"*	21-7/8" x 14-1/4" x 10-3/4"	18-3/4"	1	9 lbs	WUS954/974	1	DUS954	6	AL-23	24
QUS955	23-7/8" x 18-1/4" x 12"	21-1/2" x 16" x 11-3/4"	17-3/4"	1	8 lbs	WUS955/975	1	DUS955	6	AL-23	24
QUS965MOB	23-7/8" x 18-1/4" x 12"*	21-1/2" x 16" x 11-3/4"	17-3/4"	1	10 lbs	WUS955/975	1	DUS955	6	AL-23	24

* With caster, overall height for mobile container will be increased by 3"



LOWEST PRICE GUARANTEED!

HULK 24" Container Steel Shelving Systems - Complete Packages



2475-950
24"D x 36"W x 75"H
8 shelves and 28 QUS950
23-7/8"L x 8-1/4"W x 7"H bins



2475-951
24"D x 36"W x 75"H
7 shelves and 24 QUS951
23-7/8"L x 8-1/4"W x 9"H bins



2475-952
24"D x 36"W x 75"H
8 shelves and 21 QUS952
23-7/8"L x 11"W x 7"H bins



2475-953
24"D x 36"W x 75"H
6 shelves and 15 QUS953
23-7/8"L x 11"W x 10"H bins



2475-954
24"D x 36"W x 75"H
6 shelves and 10 QUS954
23-7/8"L x 16-1/2"W x 11"H bins



2475-950952
24"D x 36"W x 75"H
8 shelves and 12 QUS950
23-7/8"L x 8-1/4"W x 7"H bins
and **12 QUS952**
23-7/8"L x 11"W x 7"H bins



2475-953954
24"D x 36"W x 75"H
6 shelves and 9 QUS953
23-7/8"L x 11"W x 10"H bins
and **4 QUS954**
23-7/8"L x 16-1/2"W x 11"H bins



2475-20-MIX
24"D x 36"W x 75"H
7 shelves and 8 QUS950
23-7/8"L x 8-1/4"W x 7"H bins
and **3 QUS952**
23-7/8"L x 11"W x 7"H bins
and **4 QUS951**
23-7/8"L x 8-1/4"W x 9"H bins
and **3 QUS953**
23-7/8"L x 11"W x 10"H bins
and **2 QUS954**
23-7/8"L x 16-1/2"W x 11"H bins

CLEAR VIEW
BINNS
AVAILABLE on pg. 24

COMPLETE PACKAGES WITH BINS

HULK
containers

HULK 24" Container Wire Shelving Systems - Complete Packages

800 lb. CAPACITY PER SHELF



WR8-950
24"W x 36"L x 74"H
8 shelves and 28 QUS950
23-7/8"L x 8-1/4"W x 7"H bins



WR7-951
24"W x 36"L x 74"H
7 shelves and 24 QUS951
23-7/8"L x 8-1/4"W x 9"H bins



WR8-952
24"W x 36"L x 74"H
8 shelves and 21 QUS952
23-7/8"L x 11"W x 7"H bins



WR6-953
24"W x 36"L x 74"H
6 shelves and 15 QUS953
23-7/8"L x 11"W x 10"H bins



WR6-954
24"W x 36"L x 74"H
6 shelves and 10 QUS954
23-7/8"L x 16-1/2"W x 11"H bins

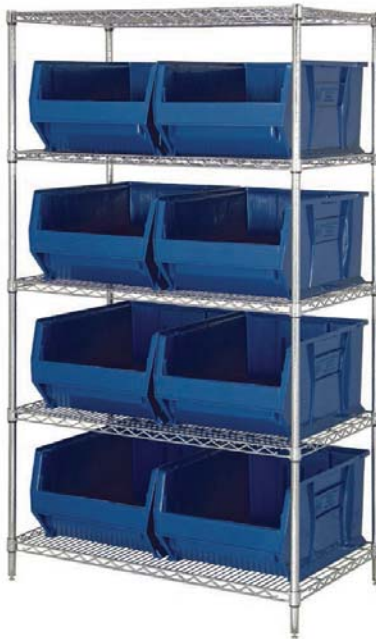

WR5-955
24"W x 42"L x 74"H
5 shelves and 8 QUS955
23-7/8"L x 18-1/4"W x 12"H bins



WR8-950952
24"W x 36"L x 74"H
8 shelves and 12 QUS950
23-7/8"L x 8-1/4"W x 7"H bins
and 12 QUS952
23-7/8"L x 11"W x 7"H bins



WR7-20-MIX
24"W x 36"L x 74"H
7 shelves and 8 QUS950
23-7/8"L x 8-1/4"W x 7"H bins
and 3 QUS952
23-7/8"L x 11"W x 7"H bins
and 4 QUS951
23-7/8"L x 8-1/4"W x 9"H bins
and 3 QUS953
23-7/8"L x 11"W x 10"H bins
and 2 QUS954 bins
23-7/8"L x 16-1/2"W x 11"H bins



MOBILIZE YOUR WIRE SHELVING

DB - Donut Bumper
Non-marking donut bumper used to protect walls and help cushion impact.

WR-00H (Mobile Kit)
Set of four swivel polyurethane 5" x 1-1/4" casters, two with brakes. Can be used with all units shown. 1,200 lb. load capacity.

CLEAR VIEW
AVAILABLE on pg. 24

HULK
containers



14 SIZES AND 3 COLORS AVAILABLE SIZE DOES MATTER

QUS974

HULK containers

QUS973

QUS975

QUS970

QUS976

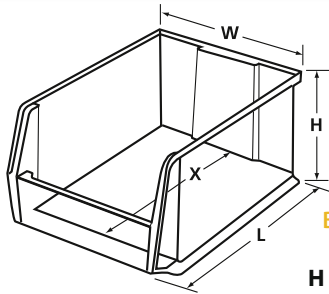

Clear Plastic Window Front
Increases bin capacity and provides a quick view of the bin contents.
(Sold separately)



Bin Dimensions Guide
L (length) W (width)
H (height) X (inside length)

Adhesive clear label holder & inserts.
AL-23
2" x 3-1/2" (Fits bins 12"H and shorter)
AL-35
3" x 5" (Fits bins 15"H and taller)
(Sold separately)



QUS997

HULK 30" & 36" Containers



Organize and store your large and bulky items with these strong injection molded high impact polypropylene, stackable containers. These extra large stacking containers offer a generous 2-1/2 - 3 feet in length to store your larger items. These huge stack bins are ideal for heavy-duty, extra deep shelving and are available in a variety of widths and heights. Heavy-duty front, back and side grips allow for easy handling. Wide stacking ledge and anti-slide lock keep stacked bins steady and prevent forward shifting. Waterproof bins are corrosion-free. Bins are autoclavable up to 250°F and are resistant to extreme cold. Available in 3 colors.

Available in: ● Blue ● Red ● Yellow

MODEL NO.	OUTSIDE DIMENSIONS L" x W" x H"	INSIDE DIMENSIONS L" x W" x H"	X"	CTN QTY	CTN WGT	CLEAR WINDOW	CTN QTY	DIVIDER	CTN QTY
HULK 30" Containers									
QUS970	29-7/8" x 8-1/4" x 7"	27-7/8" x 6-1/4" x 6-3/4"	25"	6	23 lbs	WUS950/970	6	DUS970	6
QUS973	29-7/8" x 11" x 10"	27-7/8" x 8-7/8" x 9-5/8"	24-3/4"	4	22 lbs	WUS953/973	4	DUS973	4
QUS974	29-7/8" x 16-1/2" x 11"	27-5/8" x 14-1/4" x 10-5/8"	24-3/4"	1	8 lbs	WUS954/974	1	DUS974	1
QUS984MOB	29-7/8" x 16-1/2" x 11"	27-5/8" x 14-1/4" x 10-5/8"	24-3/4"	1	10 lbs	WUS954/974	1	DUS974	1
QUS975	29-7/8" x 18-1/4" x 12"	27-1/2" x 16" x 11-3/4"	23-3/4"	1	9 lbs	WUS955/975	1	DUS975	1
QUS985MOB	29-7/8" x 18-1/4" x 12"	27-1/2" x 16" x 11-3/4"	23-3/4"	1	11 lbs	WUS955/975	1	DUS975	1
QUS976	29-7/8" x 16-1/2" x 15"	27-3/8" x 14" x 14-3/4"	23-1/2"	1	10 lbs	WUS976	1	DUS976	1
QUS986MOB	29-7/8" x 16-1/2" x 15"	27-3/8" x 14" x 14-3/4"	23-1/2"	1	12 lbs	WUS976	1	DUS976	1
HULK 36" Containers									
QUS993	35-7/8" x 16-1/2" x 17-1/2"	33-1/8" x 14" x 17-1/4"	28-1/4"	1	14 lbs	-	-	DUS993	1
QUS994MOB	35-7/8" x 16-1/2" x 17-1/2"	33-1/8" x 14" x 17-1/4"	28-1/4"	1	17 lbs	-	-	DUS993	1
QUS995	35-7/8" x 19-7/8" x 17-1/2"	33-1/8" x 17-3/8" x 17-1/4"	28-1/4"	1	15 lbs	-	-	DUS995	1
QUS996MOB	35-7/8" x 19-7/8" x 17-1/2"	33-1/8" x 17-3/8" x 17-1/4"	28-1/4"	1	17 lbs	-	-	DUS995	1
QUS997	35-7/8" x 23-7/8" x 17-1/2"	33-1/4" x 21-3/8" x 17-1/4"	28-1/4"	1	18 lbs	-	-	DUS997	1
QUS998MOB	35-7/8" x 23-7/8" x 17-1/2"	33-1/4" x 21-3/8" x 17-1/4"	28-1/4"	1	20 lbs	-	-	DUS997	1

* With casters, overall height for mobile container will be increased by 3"



HULK 30" Container Wire Shelving Systems - Complete Packages

700 lb. CAPACITY PER SHELF



WR8-970
30"W x 36"L x 74"H
8 shelves and 28 QUS970
29-7/8"L x 8-1/4"W x 7"H bins



WR6-973
30"W x 36"L x 74"H
6 shelves and 15 QUS973
29-7/8"L x 11"W x 10"H bins



WR6-974
30"W x 36"L x 74"H
6 shelves and 10 QUS974
29-7/8"L x 16-1/2"W x 11"H bins



WR6-973974
30"W x 36"L x 74"H
6 shelves and 9 QUS973
29-7/8"L x 11"W x 10"H bins
and **4 QUS974**
29-7/8"L x 16-1/2"W x 11"H bins

HULK
containers

QUANTUM CHROME WIRE SHELVING SYSTEMS COMPLETE WITH BINS



MOBILIZE YOUR WIRE SHELVING

DB - Donut Bumper
Non-marking donut bumper used to protect walls and help cushion impact.

WR-00H (Mobile Kit)
Set of four swivel polyurethane 5" x 1-1/4" casters, two with brakes. Can be used with all units shown. 1,200 lb. load capacity.



WR5-975
30"W x 42"L x 74"H
5 shelves and 8 QUS975
29-7/8"L x 18-1/4"W x 12"H bins



LOWEST PRICE GUARANTEED!

HULK 36" Container Wire Shelving Systems - Complete Packages



WR5-993
36"W x 36"L x 86"H
5 shelves and 8 QUS993
35-7/8"L x 16-1/2"W x 17-1/2"H bins



WR5-995
36"W x 48"L x 86"H
5 shelves and 8 QUS995
35-7/8"L x 19-7/8"W x 17-1/2"H bins

HULK
containers

SIZE
DOES MATTER

600 lb.
CAPACITY PER SHELF



WR5-997
36"W x 60"L x 86"H
5 shelves and 8 QUS997
35-7/8"L x 23-7/8"W x 17-1/2"H bins

QUANTUM CHROME
WIRE SHELVING
SYSTEMS COMPLETE
WITH BINS



MOBILIZE YOUR WIRE SHELVING

DB - Donut Bumper

Non-marking donut bumper used to protect walls and help cushion impact.

WR-00H (Mobile Kit)

Set of four swivel polyurethane 5" x 1-1/4" casters, two with brakes. Can be used with all units shown. 1,200 lb. load capacity.

RackBin 42" Containers



- These extra large bins offer a generous 42" (3-1/2 Feet) in length to store your larger items
- 42" length ensures no wasted space on 42" deep rack
- Heavy-duty front, back and side grips allow for easy handling
- Wide stacking ledge and anti-slide lock keep stack bins steady and prevent forward shifting
- Have eight 1/4" drill hole pattern on bottom of bin for easy hole insertion for drainage and air circulation if needed
- Waterproof bins are corrosion free
- Available in 2 colors

Available in: ● Blue ● Gray

MODEL NO.	OUTSIDE DIMENSIONS L" x W" x H"	INSIDE DIMENSIONS L" x W" x H"	X	CTN QTY	CTN WGT
QRB166	41-7/8" x 16-1/2" x 17-1/2"	40-1/8" x 14" x 16-1/2"	35"	1	16 lbs
QRB176MOB	41-7/8" x 16-1/2" x 17-1/2"*	40-1/8" x 14" x 16-1/2"	35"	1	18 lbs
QRB206	41-7/8" x 19-7/8" x 17-1/2"	40-1/8" x 17-3/8" x 16-1/2"	35"	1	17 lbs
QRB216MOB	41-7/8" x 19-7/8" x 17-1/2"*	40-1/8" x 17-3/8" x 16-1/2"	35"	1	19 lbs
QRB246	41-7/8" x 23-7/8" x 17-1/2"	40-1/8" x 21-1/2" x 16-1/2"	35"	1	19 lbs
QRB256MOB	41-7/8" x 23-7/8" x 17-1/2"*	40-1/8" x 21-1/2" x 16-1/2"	35"	1	21 lbs

* With casters, overall height for mobile container will be increased by 3"



AL-35
3" x 5"
Adhesive clear label holder & inserts. Package of 24 (Sold separately)

Smooth label area

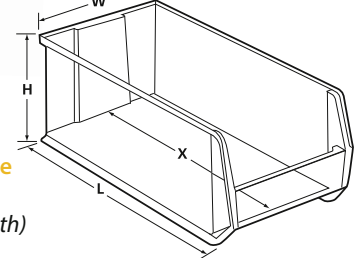

Bin Dimensions Guide
L (length) W (width)
H (height) X (inside length)

3 SIZES AND 2 COLORS AVAILABLE



THE FIRST & ONLY BIN DESIGNED SPECIFICALLY TO FIT PALLET RACK



**LOWEST PRICE
GUARANTEED!**

RackBin 42" Container Wire Shelving Systems - Complete Packages



WRA86-2142C-206

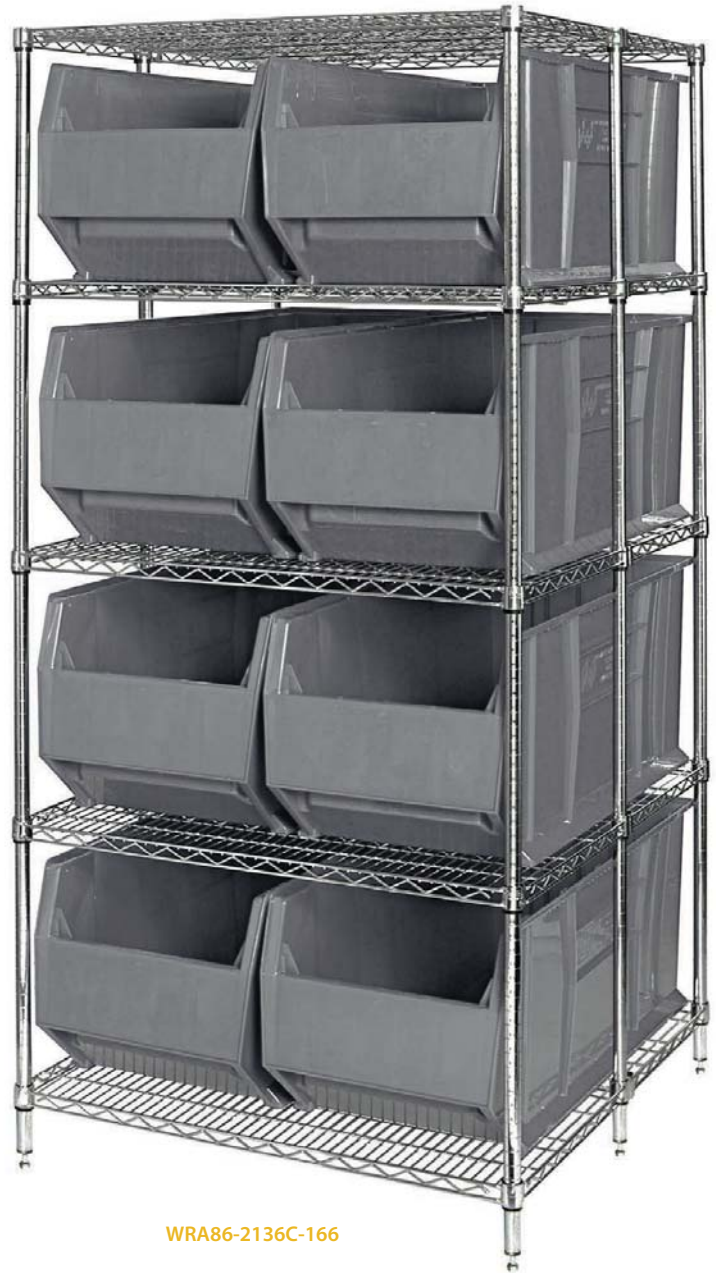

WRA86-2136C-166



**COMPLETE PACKAGES
WITH BINS**

Available in: ● Blue ● Gray

MODEL NO.	DIMENSIONS W" x L" x H"	NO. OF CONTAINERS	CONTAINER SIZE L" x W" x H"	SHIP WGT
WRA86-2136C-166	42" x 36" x 86"	8 QRB166	41-7/8" x 16-1/2" x 17-1/2"	272 lbs
WRA86-2142C-206	42" x 42" x 86"	8 QRB206	41-7/8" x 19-7/8" x 17-1/2"	290 lbs
WRA86-2148C-246	42" x 48" x 86"	8 QRB246	41-7/8" x 23-7/8" x 17-1/2"	326 lbs
WRA86-2154C-166	42" x 54" x 86"	12 QRB166	41-7/8" x 16-1/2" x 17-1/2"	386 lbs
WRA86-2172C-246	42" x 72" x 86"	12 QRB246	41-7/8" x 23-7/8" x 17-1/2"	502 lbs



5 SIZES AND 6 COLORS AVAILABLE



AVAILABLE on pg. 25



QGH600



QGH700



QGH800



AL-23
2" x 3-1/2"
Adhesive clear label
holder & inserts.
Package of 24
(Sold separately)



Curved lip and
corners provide added
strength

Large label holder
allows for quick
part identification
LGH700
(Precut labels sold
separately)

Smooth
label area

Large and comfortable
grip side handles allow
for easy carrying
and handling

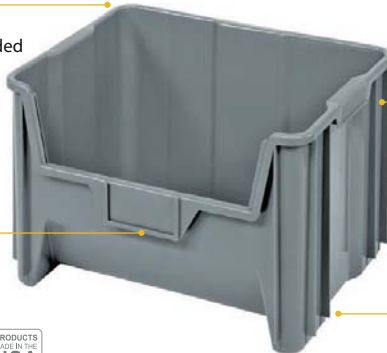

Ribs on side of bin
provide added
stability when
stacked

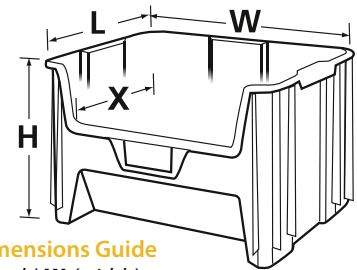

Bin Dimensions Guide

L (length) W (width)
H (height) X (inside length)

Giant Stack Containers



Multipurpose, wide open hopper front provides easy access for large part storage. Ideal for multiple applications in recycling, storing parts and components. This bin will stack up to 6 bins high creating a sturdy, tall storage system. Bins are injection molded from high density polypropylene, easy to clean, resist corrosion and are impervious to most chemicals. Large label holder allows for quick identification. Optional clear window front increases storage capacity and allows for quick identification of parts. Six 1/4" drill hole pattern on bottom of bin allow for easy hole insertion for drainage and air circulation. See **pg. 25** to order Clear Bins.

QGH700 available in: ● Blue ● Ivory ● Red ● Black ● Gray ● Clear

QGH600 and QGH800 available in: ● Blue ● Red ● Gray ● Clear

MODEL NO.	OUTSIDE DIMENSIONS L" x W" x H"	INSIDE DIMENSIONS L" x W" x H"	X"	CAP CU FT	CTN QTY	CTN WGT	WINDOW	CTN QTY
QGH600	17-1/2" x 10-7/8" x 12-1/2"	15-5/8" x 8" x 12-1/4"	13-1/2"	0.98	4	12 lbs	WGH600	4
QGH700*	15-1/4" x 19-7/8" x 12-7/16"	13-5/8" x 17-1/2" x 12-1/4"	11-1/2"	1.7	3	13 lbs	WGH700	3
QGH800	17-1/2" x 16-1/2" x 12-1/2"	15-5/8" x 13-3/4" x 12-1/4"	13-1/2"	1.6	2	8 lbs	WGH800	2

* Optional label for QGH700 is available, LGH700 (3 per package)

PERFORMANCE FEATURES:

- Extra thick side walls with reinforced rib designed for strength, allowing for 100 lb. stack capacity per bin
- Large grip side handles
- Stacks 6 bins high
- Six 1/4" drill hole pattern on bottom of bin allows for easy hole insertion for drainage

Mobile Giant Stack Containers



- Ideal for transport of heavy and bulky parts
- Container comes with 4 swivel, 3" casters, all with brakes, allowing for up to 250 lb. mobile load capacity
- Containers can stack with casters in place

QGH705MOB available in: ● Blue ● Ivory ● Red ● Black ● Gray ● Clear

QGH805MOB available in: ● Blue ● Red ● Gray ● Clear

MODEL NO.	OUTSIDE DIMENSIONS L" x W" x H"	INSIDE DIMENSIONS L" x W" x H"	X"	CAP CU FT	CTN QTY	CTN WGT	WINDOW	CTN QTY
QGH705MOB	15-1/4" x 19-7/8" x 12-7/16"	13-5/8" x 17-1/2" x 12-1/4"	11-1/2"	1.7	3	22 lbs	WGH700	3
QGH805MOB	17-1/2" x 16-1/2" x 12-1/2"	15-5/8" x 13-3/4" x 12-1/4"	13-1/2"	1.6	2	17 lbs	WGH800	2

* With casters, overall height for mobile container will be increased by 3"



QGH705MOB



QGH805MOB



Clear Plastic Window Front
Increases bin capacity and
provides a quick view of
the bin contents.
(Sold separately)



LOWEST PRICE GUARANTEED!

Giant Stack Container Storage Center - Complete Packages

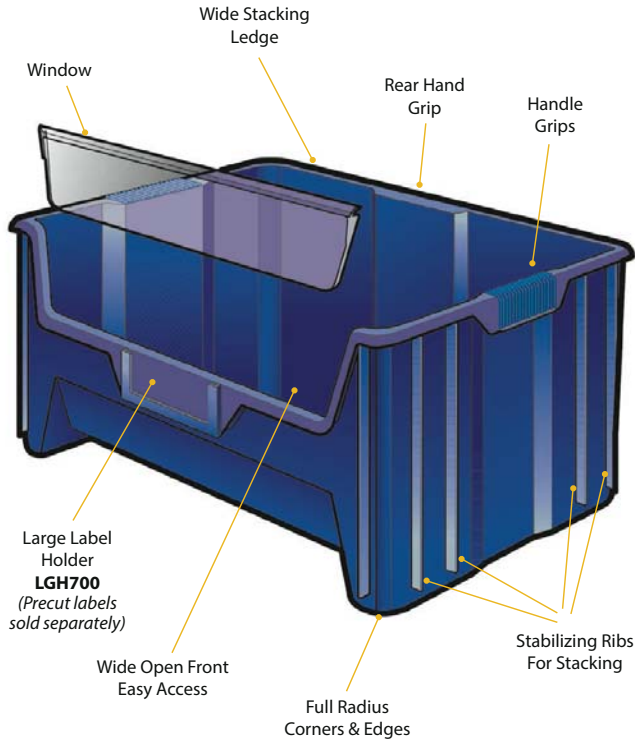

Organize, store and access your medium or large parts with this high capacity bin center. 400 lb. capacity per shelf and over 21 cubic feet of storage space. Smooth powder coat finish and cross bracing for increased stability. Easy assembly. **QSBU-700** is available in Red, Gray, Blue, Ivory and Black. **QSBU-600**, **QSBU-600800** and **QSBU-800** are available in Gray, Blue and Red. Please specify color. One color per unit.



AVAILABLE on pg. 25



QGH700CL



QSBU-700
18"D x 42"W x 75"H
6 shelves & 10 QGH700 bins

400 lb.
CAPACITY PER SHELF

COMPLETE PACKAGES WITH BINS



QSBU-600
18"D x 36"W x 75"H
6 shelves & 15 QGH600 bins



QSBU-600800
18"D x 36"W x 75"H
6 shelves, 6 QGH600 bins and 6 QGH800 bins



QSBU-800
18"D x 36"W x 75"H
6 shelves & 10 QGH800 bins

Giant Stack Container Wire Shelving Systems - Complete Packages



WR5-600
18"W x 36"L x 74"H
5 shelves and 12 QGH600
17-1/2"L x 10-7/8"W x 12-1/2"H bins



WR5-600800
18"W x 36"L x 74"H
5 shelves and 6 QGH600 17-1/2"L x 10-7/8"W x 12-1/2"H bins
and 4 QGH800 17-1/2"L x 16-1/2"W x 12-1/2"H bins

**COMPLETE
PACKAGES
WITH BINS**

CLEAR VIEW
AVAILABLE on pg. 25

**800 lb.
CAPACITY PER SHELF**

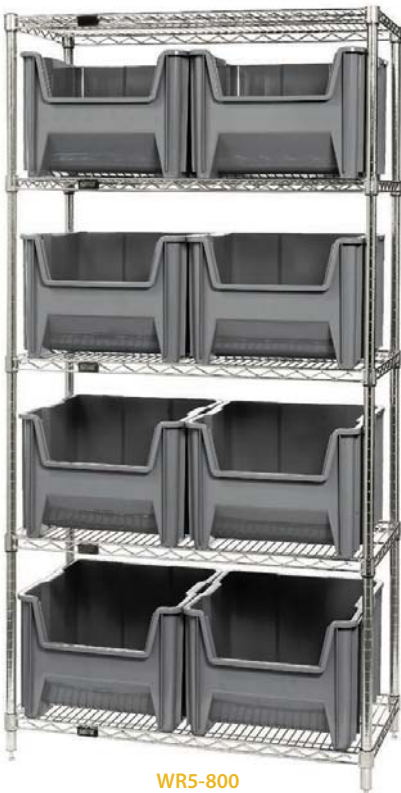

WR5-800
18"W x 36"L x 74"H
5 shelves and 8 QGH800
17-1/2"L x 16-1/2"W x 12-1/2"H bins



WR5-700
18"W x 42"L x 74"H
5 shelves and 8 QGH700
15-1/4"L x 19-7/8"W x 12-7/16"H bins



MOBILIZE YOUR WIRE SHELVING

DB - Donut Bumper
Non-marking donut bumper used to protect walls and help cushion impact.

WR-00H (Mobile Kit)
Set of four swivel polyurethane 5" x 1-1/4" casters, two with brakes. Can be used with all units shown. 1,200 lb. load capacity.



LOWEST PRICE GUARANTEED!

6 SIZES AND 5 COLORS AVAILABLE



MAGNUM

- PERFORMANCE FEATURES:**
- Available in 5 sizes and 5 colors (Blue, Green, Red, Yellow and Black) for inventory control and color code efficiency
 - These heavy-duty containers are injection molded from high density polypropylene and are ideal for storage and transport of large parts
 - Extra heavy, double wall thickness allow containers to stack securely

MAGNUM Bins - Super Strong and Durable

Heavy-duty, extra strong injection molded, high density polypropylene bins are ideal for transportation and storage of large and heavy components. Open hopper front allows immediate access and visibility. Ribbed reinforced walls ensure extra strength. Double wall thickness with preformed lip allows bin to interlock and provides up to 150 lb. stack capacity. Transport these bins easily with rear molded handle. Molded in label slot. Impervious to most solvents, corrosion, rust and rot resistant. Resists temperatures from -40°F to 250°F. Optional window front maximizes storage and prevents spillage. Optional dividers maximize flexibility and keeps contents organized. Available in 5 colors.

Available in: ● Blue ● Green ● Red ● Yellow ● Black

MODEL NO.	OUTSIDE DIMENSIONS L" x W" x H"	INSIDE DIMENSIONS L" x W" x H"	CTN QTY	CTN WGT	DIVIDERS	CTN QTY	WINDOWS	CTN QTY
QMS531	19-3/4" x 12-3/8" x 5-7/8"	17-3/4" x 11-1/4" x 5-1/8"	6	19 lbs	DMS531	6	WMS531	6
QMS532	19-3/4" x 12-3/8" x 7-7/8"	17-3/4" x 11-1/4" x 7-1/4"	6	23 lbs	DMS532	6	WMS532	6
QMS533	19-3/4" x 12-3/8" x 11-7/8"	17-3/4" x 11-1/4" x 11"	3	15 lbs	DMS533	3	WMS533	3
QMS543	19-3/4" x 18-3/8" x 11-7/8"	17-3/4" x 17-1/4" x 11"	1	8 lbs	DMS543	1	WMS543	1
QMS743*	29" x 18-3/8" x 11-7/8"	26-3/4" x 17-1/4" x 11"	1	10 lbs	-	-	-	-
QMS843MOB*	29" x 18-3/8" x 14-7/8"	26-3/4" x 17-1/4" x 11"	1	14 lbs	-	-	-	-

Individual labels are available for all MAGNUM Bins. For label Model No. substitute "L" for "Q" in bin Model No. Ctn Qty: 50 Individual Labels
* Includes Heavy-Duty spread bar for extra strength and support.



LTR-1754
Clear Label Holder & Insert
Fits all Magnum bin sizes.
Package of 25.



ATTACHED PULL RING
allows dolly to be pulled with ease



QMS743 and QMS843MOB
Includes heavy-duty spread bar for extra strength and support

Polymer Mobile Dolly

DLY-3018 Dolly with Padded Rubber Trim available in Blue. 1,000 lb. capacity. Dimensions 30"L x 18"W

MODEL NO.	DESCRIPTION	CTN WGT
DLY-3018	Dolly with Padded Rubber Trim	19 lbs
HANDLE-DLY	32" Dolly Pull Rod with Handle	2 lbs

Bins sold separately.



Clear Window Front
Increases bin capacity and provides a quick view of the bin contents. (Optional)



MAGNUM BIN
Shown with optional divider

Mobile MAGNUM Bins

- Bin comes with 4 swivel 3" casters, all with brakes, allowing for 250 lb. mobile capacity
- Bins can stack on each other with casters in place
- **QMS843MOB** includes heavy-duty spread bar

MAGNUM Bin Steel Shelving Systems - Complete Packages



These ultra heavy-duty shelving systems incorporate Quantum's Giant MAGNUM bins. Five combinations allow you a wide selection to choose from. Bins offer optional clear window fronts as well as dividers for maximum storage capacity. Shelving is tough 42" wide with a 400 lb. load capacity per shelf. Smooth powder coat finish which will not rust or corrode. Bins are available in Blue, Yellow, Green, Red and Black.

**COMPLETE
PACKAGES
WITH BINS**



18" Deep Units

18"D x 42"W x 75"H Shelving



MSU-531
10 shelves and 27 QMS531
19-3/4"L x 12-3/8"W x 5-7/8"H bins



MSU-16-MIX
7 shelves and 4 QMS543
19-3/4"L x 18-3/8"W x 11-7/8"H bins,
3 QMS533
19-3/4"L x 12-3/8"W x 11-7/8"H bins,
6 QMS532
19-3/4"L x 12-3/8"W x 7-7/8"H bins,
3 QMS531
19-3/4"L x 12-3/8"W x 5-7/8"H bins

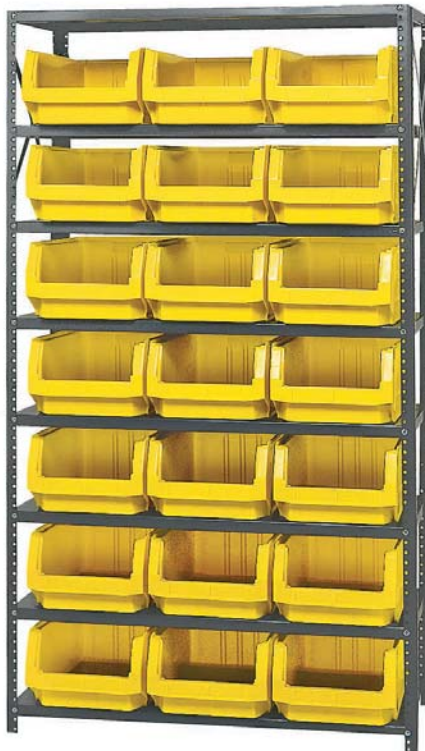

MSU-532
8 shelves and 21 QMS532
19-3/4"L x 12-3/8"W x 7-7/8"H bins



MSU-533
6 shelves and 15 QMS533
19-3/4"L x 12-3/8"W x 11-7/8"H bins



MSU-543
6 shelves and 10 QMS543
19-3/4"L x 18-3/8"W x 11-7/8"H bins



LOWEST PRICE GUARANTEED!

MAGNUM Bin Wire Shelving Systems - Complete Packages



WR9-531
18"W x 42"L x 74"H
9 shelves and 24 QMS531
19-3/4"L x 12-3/8"W x 5-7/8"H bins



WR7-532
18"W x 42"L x 74"H
7 shelves and 18 QMS532
19-3/4"L x 12-3/8"W x 7-7/8"H bins



WR5-533
18"W x 42"L x 74"H
5 shelves and 12 QMS533
19-3/4"L x 12-3/8"W x 11-7/8"H bins



WR5-543
18"W x 42"L x 74"H
5 shelves and 8 QMS543
19-3/4"L x 18-3/8"W x 11-7/8"H bins



800 lb.
CAPACITY PER SHELF

COMPLETE PACKAGES WITH BINS



MOBILIZE YOUR WIRE SHELVING

DB - Donut Bumper
Non-marking donut bumper used to protect walls and help cushion impact.

WR-00H (Mobile Kit)
Set of four swivel polyurethane 5" x 1-1/4" casters, two with brakes. Can be used with all units shown. 1,200 lb. load capacity.



WR6-13-MIX
18"W x 42"L x 74"H,
6 shelves and 4 QMS543 19-3/4"L x 18-3/8"W x 11-7/8"H bins
3 QMS533 19-3/4"L x 12-3/8"W x 11-7/8"H bins
3 QMS532 19-3/4"L x 12-3/8"W x 7-7/8"H bins
3 QMS531 19-3/4"L x 12-3/8"W x 5-7/8"H bins



AVAILABLE on pg. 26

13 SIZES AND 8 COLORS AVAILABLE

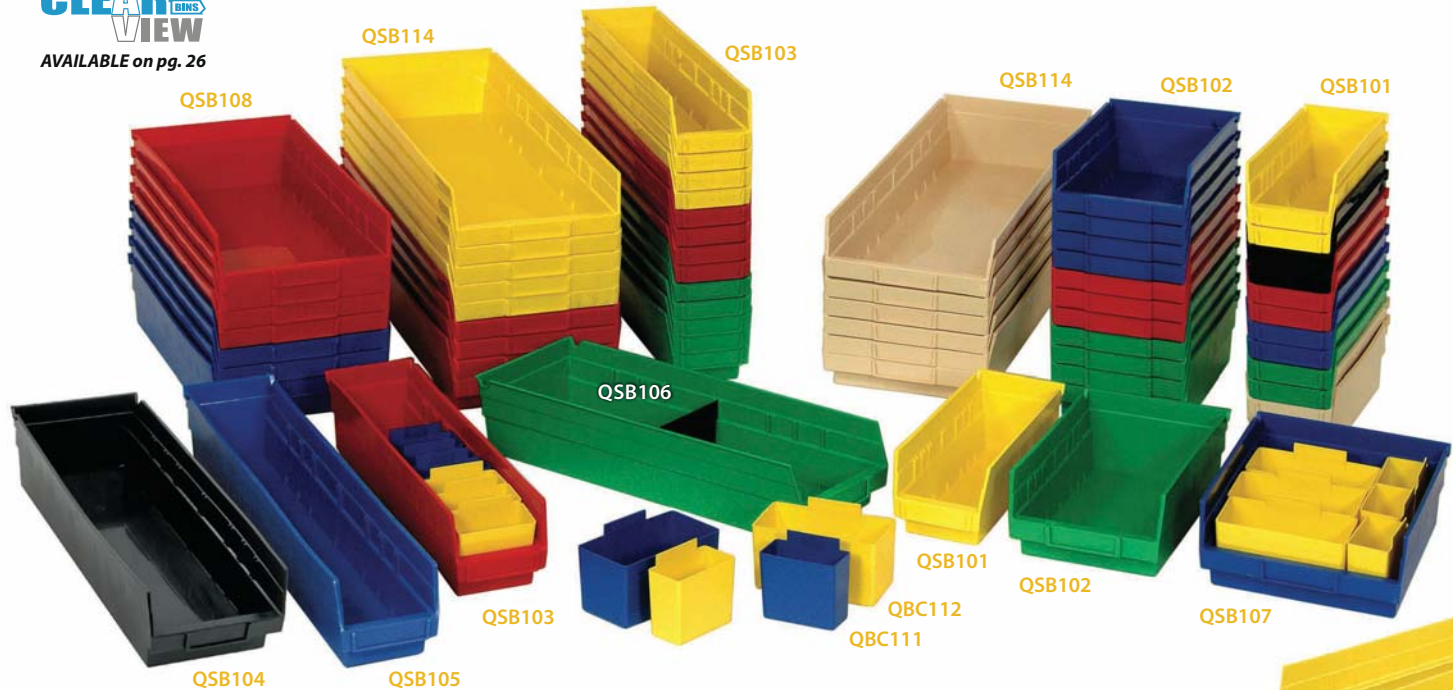

NEW

Pink color in select sizes

LOW COST, LONG LASTING, UNBREAKABLE, REUSABLE 4" HIGH BINS



LTR-0813
Clear Label Holder & Insert
Clear label holders and laser label inserts. Package of 25. Label holders fit all bins (except QSB100).

Divider Label Tab

NEW

Divider Label Tabs attach to existing dividers to improve the visibility of bin labels and scanning of barcodes. Package of 6.



DLT-6

10° Angle
45° Angle

Extended Label Holders *simplify identification*



Optional extended label holders are designed for larger bar code scanning. Label holders fit all Shelf Bins (except QSB100).

MODEL NO.	DESCRIPTION	DIMENSIONS W" x H"	CTN QTY
ELH410	10° Angle	4" x 2-1/4"	24
ELH445	45° Angle	4" x 2-1/4"	24

Economy 4" Shelf Bins



Quantum's tough, durable, high density Economy Shelf Bins are the industry standard for quality. These durable polypropylene bins feature a molded-in label holder, built-in rear hanglock which allows bins to tilt out for complete access when on shelving. A wide hopper front allows complete access to the contents of the bin. Edges are reinforced for added strength. They are designed for 12", 18" and 24" deep shelf units, racks or standard shelving. Bins are impervious to most chemicals. Available in 8 colors. See pg. 26 to order Clear Bins.

Available in: ● Blue ● Green ● Ivory ● Red ● Yellow ● Black ● Clear

QSB101, QSB102, QSB103, QSB104 also available in: ● Pink

MODEL NO.	OUTSIDE DIMENSIONS L" x W" x H"	INSIDE DIMENSIONS L" x W" x H"	CTN QTY	CTN WGT	DIVIDER	CTN QTY	NO. OF BIN CUPS PER BIN QBC111	QBC112
QSB100	11-5/8" x 2-3/4" x 4"	10-1/4" x 1-5/8" x 4"	36	13 lbs	-	-	3	0
QSB101	11-5/8" x 4-1/8" x 4"	10-1/4" x 3" x 4"	36	17 lbs	DSB101	50	6	2
QSB102	11-5/8" x 6-5/8" x 4"	10-1/4" x 5-1/2" x 4"	30	18 lbs	DSB102	50	9	4
QSB107	11-5/8" x 8-3/8" x 4"	10-1/4" x 7-1/8" x 4"	20	15 lbs	DSB107	50	12	4
QSB109	11-5/8" x 11-1/8" x 4"	10-1/4" x 10" x 4"	8	7 lbs	DSB109	50	18	6
QSB103	17-7/8" x 4-1/8" x 4"	16-1/2" x 3" x 4"	20	13 lbs	DSB103	50	9	3
QSB104	17-7/8" x 6-5/8" x 4"	16-1/2" x 5-1/2" x 4"	20	16 lbs	DSB104	50	15	6
QSB108	17-7/8" x 8-3/8" x 4"	16-1/2" x 7-1/8" x 4"	10	11 lbs	DSB108	50	19	6
QSB110	17-7/8" x 11-1/8" x 4"	16-1/2" x 10" x 4"	8	11 lbs	DSB110	50	29	8
QSB105	23-5/8" x 4-1/8" x 4"	22-1/8" x 3" x 4"	16	13 lbs	DSB105	50	13	4
QSB106	23-5/8" x 6-5/8" x 4"	22-1/8" x 5-1/2" x 4"	8	9 lbs	DSB106	50	21	8
QSB114	23-5/8" x 8-3/8" x 4"	22-1/8" x 7-1/8" x 4"	6	9 lbs	DSB114	50	24	8
QSB116	23-5/8" x 11-1/8" x 4"	22-1/8" x 10" x 4"	6	10 lbs	DSB116	50	35	16

Individual labels are available for all Shelf Bins. For label Model No. substitute "L" for "Q" in bin Model No. Ctn Qty: 50 Individual Labels



Dividers and Bin Cups



Optional dividers fit snugly, horizontally across bins and are uniquely designed to allow for easy part labeling via individual label slots. All bins can accommodate up to 7 dividers. Bin cups have a raised, slotted label holder for easy parts identification. The entire bin cup may be removed for easy part retrieval. Available in 2 sizes and 2 colors.

Available in: ● Blue ● Yellow

MODEL NO.	OUTSIDE DIMENSIONS L" x W" x H"	CTN QTY	CTN WGT
QBC111	3-1/4" x 1-3/4" x 3"	48	4 lbs
QBC112	5-1/8" x 2-3/4" x 3"	48	7 lbs



LOWEST PRICE GUARANTEED!

Economy 4" Shelf Bin Steel Shelving Systems Complete Packages

Economical small parts storage steel systems keep parts easily accessible. Open hopper front bins with label area provide fast access to stored items. This all-in-one unit is easy to clean and will not rust or corrode. Heavy-duty, high grade shelving offers a 400 lb. capacity per shelf. 36" wide shelving has a smooth powder coat finish. Bins are available in 7 colors.



1839-104



1275-102



REAR 'V' LOCK enables bins to be hung from shelf above when in use



AVAILABLE on pg. 27

ECONOMICAL SMALL PARTS STORAGE SYSTEMS KEEP PARTS EASILY ACCESSIBLE

Available in: ● Blue ● Green ● Ivory ● Red ● Yellow ● Black ● Clear

MODEL NO.	NO. OF BINS	BIN SIZE L" x W" x H"	SHIP WGT
12" x 36" x 75" 13 Shelf Systems			
1275-100	144 QSB100	11-5/8" x 2-3/4" x 4"	139 lbs
1275-101	96 QSB101	11-5/8" x 4-1/8" x 4"	117 lbs
1275-102	60 QSB102	11-5/8" x 6-5/8" x 4"	115 lbs
1275-107	48 QSB107	11-5/8" x 8-3/8" x 4"	120 lbs
1275-109	36 QSB109	11-5/8" x 11-1/8" x 4"	119 lbs
1275-000	Shelving Unit - No Bins		87 lbs
12" x 36" x 39" 7 Shelf Systems			
1239-100	72 QSB100	11-5/8" x 2-3/4" x 4"	75 lbs
1239-101	48 QSB101	11-5/8" x 4-1/8" x 4"	67 lbs
1239-102	30 QSB102	11-5/8" x 6-5/8" x 4"	63 lbs
1239-107	24 QSB107	11-5/8" x 8-3/8" x 4"	64 lbs
1239-109	18 QSB109	11-5/8" x 11-1/8" x 4"	65 lbs
1239-000	Shelving Unit - No Bins		49 lbs
18" x 36" x 75" 13 Shelf Systems			
1875-103	96 QSB103	17-7/8" x 4-1/8" x 4"	161 lbs
1875-104	60 QSB104	17-7/8" x 6-5/8" x 4"	155 lbs
1875-108	48 QSB108	17-7/8" x 8-3/8" x 4"	161 lbs
1875-110	36 QSB110	17-7/8" x 11-1/8" x 4"	158 lbs
1875-000	Shelving Unit - No Bins		113 lbs
18" x 36" x 39" 7 Shelf Systems			
1839-103	48 QSB103	17-7/8" x 4-1/8" x 4"	87 lbs
1839-104	30 QSB104	17-7/8" x 6-5/8" x 4"	84 lbs
1839-108	24 QSB108	17-7/8" x 8-3/8" x 4"	87 lbs
1839-110	18 QSB110	17-7/8" x 11-1/8" x 4"	86 lbs
1839-000	Shelving Unit - No Bins		63 lbs

COMPLETE PACKAGES WITH BINS

COLOR CODE PRODUCTS TO SIMPLIFY ORDER PICKING AND INVENTORY CONTROL





Economy 4" Shelf Bin Sloped Shelving Systems
Complete Packages



AVAILABLE on pg. 27

Pick Racks provide a convenient high density, easy access, sloped shelving system, available as bench units, single and double sided free standing and mobile units. Unit comes complete with Economical Shelf Bins. Sloped shelving unit keeps small and medium sized parts easily accessible. Open hopper front bins with label area, provide fast access to stored items. This all-in-one unit is easy to clean and will not rust or corrode. See chart for configurations. Bins are available in 7 colors. One bin color per unit.



QPRHA-102
Bench Pick Rack
250 lb. capacity.

**SLOPED SHELVES, EASY ACCESS,
MOST POPULAR & VERSATILE STORAGE
SYSTEMS SOLD**



QPRD-102 + QDU-00
Mobile, Double Sided Pick Rack
1,000 lb. capacity.



QPRD-107
Double Sided Pick Rack
800 lb. capacity.



QPRS-101
Single Sided Pick Rack
400 lb. capacity.

Available in: ● Blue ● Green ● Ivory ● Red ● Yellow ● Black ● Clear

MODEL NO.	NO. OF BINS	BIN SIZE L" x W" x H"	SHIP WGT
12-1/2" x 36" x 23" 3 Shelf Bench Rack Systems			
QPRHA-100	36 QSB100	11-5/8" x 2-3/4" x 4"	41 lbs
QPRHA-101	24 QSB101	11-5/8" x 4-1/8" x 4"	38 lbs
QPRHA-102	15 QSB102	11-5/8" x 6-5/8" x 4"	36 lbs
QPRHA-107	12 QSB107	11-5/8" x 8-3/8" x 4"	36 lbs
QPRHA-109	9 QSB109	11-5/8" x 11-1/8" x 4"	37 lbs
QPRHA-000	Bench Rack Only - No Bins		
12" x 36" x 60" Single Sided 8 Shelf Rack Systems			
QPRS-100	96 QSB100	11-5/8" x 2-3/4" x 4"	99 lbs
QPRS-101	64 QSB101	11-5/8" x 4-1/8" x 4"	85 lbs
QPRS-102	40 QSB102	11-5/8" x 6-5/8" x 4"	80 lbs
QPRS-107	32 QSB107	11-5/8" x 8-3/8" x 4"	81 lbs
QPRS-109	24 QSB109	11-5/8" x 11-1/8" x 4"	83 lbs
QPRS-000	12" x 36" x 60" Rack Only - No Bins		
NEW 18" x 36" x 60" Single Sided 8 Shelf Rack Systems			
QPRS-103	64 QSB103	17-7/8" x 4-1/8" x 4"	124 lbs
QPRS-104	40 QSB104	17-7/8" x 6-5/8" x 4"	110 lbs
QPRS-108	32 QSB108	17-7/8" x 8-3/8" x 4"	115 lbs
QPRS-110	24 QSB110	17-7/8" x 11-1/8" x 4"	111 lbs
QPRS18-000	18" x 36" x 60" Rack Only - No Bins		
24" x 36" x 60" Double Sided 16 Shelf Rack Systems			
QPRD-100	192 QSB100	11-5/8" x 2-3/4" x 4"	195 lbs
QPRD-101	128 QSB101	11-5/8" x 4-1/8" x 4"	169 lbs
QPRD-102	80 QSB102	11-5/8" x 6-5/8" x 4"	158 lbs
QPRD-107	64 QSB107	11-5/8" x 8-3/8" x 4"	160 lbs
QPRD-109	48 QSB109	11-5/8" x 11-1/8" x 4"	163 lbs
QPRD-000	24" x 36" x 60" Rack Only - No Bins		
QDU-00	Mobile Kit - Mobilizes All 24" Deep Double Sided Units		
NEW 36" x 36" x 60" Double Sided 16 Shelf Rack Systems			
QPRD-103	128 QSB103	17-7/8" x 4-1/8" x 4"	241 lbs
QPRD-104	80 QSB104	17-7/8" x 6-5/8" x 4"	220 lbs
QPRD-108	64 QSB108	17-7/8" x 8-3/8" x 4"	226 lbs
QPRD-110	48 QSB110	17-7/8" x 11-1/8" x 4"	222 lbs
QPRD18-000	36" x 36" x 60" Rack Only - No Bins		
QDU-18	Mobile Kit - Mobilizes All 36" Deep Double Sided Units		



LOWEST PRICE GUARANTEED!



WR12-101

COMPLETE PACKAGES WITH BINS



AVAILABLE on pg. 26

800 lb. CAPACITY PER SHELF



MOBILIZE YOUR WIRE SHELVING

DB - Donut Bumper

Non-marking donut bumper used to protect walls and help cushion impact.

WR-00H (Mobile Kit)*

Set of four swivel polyurethane 5" x 1-1/4" casters, two with brakes. Can be used with all units shown. 1,200 lb. load capacity. *Mobile kits recommended only for shelves 18" and wider.

Economy 4" Shelf Bin Wire Shelving Systems Complete Packages

Available in: ● Blue ● Green ● Ivory ● Red ● Yellow ● Black ● Clear

MODEL NO.	NO. OF BINS	BIN SIZE L" x W" x H"	SHIP WGT
12" x 36" x 74" 12 Shelf Systems			
WR12-101	88 QSB101	11-5/8" x 4-1/8" x 4"	120 lbs
WR12-102	55 QSB102	11-5/8" x 6-5/8" x 4"	116 lbs
WR12-107	44 QSB107	11-5/8" x 8-3/8" x 4"	117 lbs
WR12-109	33 QSB109	11-5/8" x 11-1/8" x 4"	119 lbs
18" x 36" x 74" 12 Shelf Systems			
WR12-103	88 QSB103	17-7/8" x 4-1/8" x 4"	176 lbs
WR12-104	55 QSB104	17-7/8" x 6-5/8" x 4"	165 lbs
WR12-108	44 QSB108	17-7/8" x 8-3/8" x 4"	170 lbs
WR12-110	33 QSB110	17-7/8" x 11-1/8" x 4"	168 lbs
24" x 36" x 74" 12 Shelf Systems			
WR12-105	88 QSB105	23-5/8" x 4-1/8" x 4"	228 lbs
WR12-106	55 QSB106	23-5/8" x 6-5/8" x 4"	218 lbs
WR12-114	44 QSB114	23-5/8" x 8-3/8" x 4"	222 lbs
WR12-116	33 QSB116	23-5/8" x 11-1/8" x 4"	206 lbs

Economy 4" Complete Bin Center

Complete bin systems are available with 4 different size bins on a 12"W x 36"L x 36"H unit. This all-purpose bin center is an economical high density storage system that provides easy visibility to stored contents.

- Easy boltless assembly
- Wire allows air to circulate as well as provides ideal product visibility
- Durable chrome finish ensures years of heavy-duty dependability and service
- Bins are available in 7 colors

Available in: ● Blue ● Green ● Ivory ● Red ● Yellow ● Black ● Clear

MODEL NO.	NO. OF BINS	BIN SIZE L" x W" x H"	SHIP WGT
12" x 36" x 36" 6 Shelf Systems			
WR6-36-1236-101	40 QSB101	11-5/8" x 4-1/8" x 4"	63 lbs
WR6-36-1236-102	25 QSB102	11-5/8" x 6-5/8" x 4"	50 lbs
WR6-36-1236-107	20 QSB107	11-5/8" x 8-3/8" x 4"	62 lbs
WR6-36-1236-109	15 QSB109	11-5/8" x 11-1/8" x 4"	64 lbs



WR12-102



WR12-107



WR6-36-1236-102



High Density Wire Shelving Systems

- Wire Storage Systems with bins available in 48", 60" and 72" lengths
- All units in chart below utilize 74" posts and include 12 shelves
- Non-marring caster kit **WR-00H** sold separately
- Bins are available in 7 colors



WR74-2448-66106 + WR-00H + 4 DB



MOBILIZE YOUR WIRE SHELVING

DB - Donut Bumper

Non-marking donut bumper used to protect walls and help cushion impact.

WR-00H (Mobile Kit)*

Set of four swivel polyurethane 5" x 1-1/4" casters, two with brakes. Can be used with all units shown. 1,200 lb. load capacity. *Mobile kits recommended only for shelves 18" and wider.

600-800 lb.
CAPACITY PER SHELF

Available in: ● Blue ● Green ● Ivory ● Red ● Yellow ● Black ● Clear

BIN DIMENSIONS L" x W" x H"	HIGH DENSITY WIRE SYSTEMS								
	48"L SYSTEMS			60"L SYSTEMS			72"L SYSTEMS		
MODEL NO.	NO. OF BINS	SHIP WGT	MODEL NO.	NO. OF BINS	SHIP WGT	MODEL NO.	NO. OF BINS	SHIP WGT	
12"W x 48"L Systems			12"W x 60"L Systems			12"W x 72"L Systems			
11-5/8" x 4-1/8" x 4"	WR74-1248-110101	110 QSB101	152 lbs	WR74-1260-143101	143 QSB101	208 lbs	WR74-1272-176101	176 QSB101	248 lbs
11-5/8" x 4-1/8" x 4"	WR74-1248-101102	55 QSB101	148 lbs	WR74-1260-101102	78 QSB101	213 lbs	WR74-1272-101102	80 QSB101	240 lbs
11-5/8" x 6-5/8" x 4"		36 QSB102			40 QSB102			60 QSB102	
11-5/8" x 6-5/8" x 4"	WR74-1248-66102	66 QSB102	140 lbs	WR74-1260-88102	88 QSB102	193 lbs	WR74-1272-110102	110 QSB102	230 lbs
18"W x 48"L Systems			18"W x 60"L Systems			18"W x 72"L Systems			
17-7/8" x 4-1/8" x 4"	WR74-1848-110103	110 QSB103	168 lbs	WR74-1860-143103	143 QSB103	224 lbs	WR74-1872-176103	176 QSB103	264 lbs
17-7/8" x 4-1/8" x 4"	WR74-1848-103104	55 QSB103	164 lbs	WR74-1860-103104	78 QSB103	229 lbs	WR74-1872-103104	80 QSB103	256 lbs
17-7/8" x 6-5/8" x 4"		36 QSB104			40 QSB104			60 QSB104	
17-7/8" x 6-5/8" x 4"	WR74-1848-66104	66 QSB104	156 lbs	WR74-1860-88104	88 QSB104	209 lbs	WR74-1872-110104	110 QSB104	246 lbs
24"W x 48"L Systems			24"W x 60"L Systems			24"W x 72"L Systems			
23-5/8" x 4-1/8" x 4"	WR74-2448-110105	110 QSB105	180 lbs	WR74-2460-143105	143 QSB105	256 lbs	WR74-2472-176105	176 QSB105	312 lbs
23-5/8" x 4-1/8" x 4"	WR74-2448-105106	55 QSB105	176 lbs	WR74-2460-105106	78 QSB105	261 lbs	WR74-2472-105106	80 QSB105	304 lbs
23-5/8" x 6-5/8" x 4"		36 QSB106			40 QSB106			60 QSB106	
23-5/8" x 6-5/8" x 4"	WR74-2448-66106	66 QSB106	168 lbs	WR74-2460-88106	88 QSB106	241 lbs	WR74-2472-110106	110 QSB106	294 lbs

48"L - 800 lb. Capacity/Shelf

60"L - 600 lb. Capacity/Shelf

72"L - 600 lb. Capacity/Shelf



LOWEST PRICE GUARANTEED!



AVAILABLE on pg. 28

LOW COST, LONG LASTING, UNBREAKABLE, REUSABLE, 6" HIGH BINS



12 SIZES AND 4 COLORS AVAILABLE

10° Angle

45° Angle



with **68%** more storage capacity over standard 4" shelf bins, Quantum's **Store-More 6"** Shelf Bins are an industry first and now an industry standard.

Divider Label Tab

Divider Label Tabs attach to existing dividers to improve the visibility of bin labels and scanning of barcodes. Package of 6.



DLT-6

LTR-0813

Clear Label Holder & Insert
Clear label holders and laser label inserts. Clear label holders fit all 6" Shelf Bins. Package of 25.



Extended Label Holders *simplify identification*



Optional extended label holders are designed for larger bar code scanning. Label holders fit all 6" Shelf Bins.

MODEL NO.	DESCRIPTION	DIMENSIONS W" x H"	CTN QTY
ELH410	10° Angle	4" x 2-1/4"	24
ELH445	45° Angle	4" x 2-1/4"	24

STORE-MORE 6" Shelf Bins



Maximize your storage space with durable, high density polypropylene bins. Quantum's STORE-MORE 6"H Shelf Bins are the industry standard for quality. These bins feature a molded-in label holder, built-in rear hang-lock which allows bins to tilt out for complete access when on shelving. A wide hopper front allows complete access to the contents of the bin. Edges are reinforced for added strength. They are designed for 12", 18" and 24" deep shelf units, racks or standard shelving. Optional dividers are a perfect accessory to subdivide and keep parts separated as needed. Bins are waterproof and corrosion-free. Available in 4 colors. See **pg. 28** to order Clear Bins.

Available in: ● Blue ● Red ● Yellow ● Clear

MODEL NO.	OUTSIDE DIMENSIONS L" x W" x H"	INSIDE DIMENSIONS L" x W" x H"	CTN QTY	CTN WGT	DIVIDER	CTN QTY	NO. OF BIN CUPS PER BIN	
							QBC111	QBC112
QSB201	11-5/8" x 4-1/8" x 6"	10-1/6" x 3" x 6"	36	19 lbs	DSB201	50	6	2
QSB202	11-5/8" x 6-5/8" x 6"	10-1/6" x 5-1/2" x 6"	30	20 lbs	DSB202	50	9	4
QSB207	11-5/8" x 8-3/8" x 6"	10-1/6" x 7-1/8" x 6"	20	17 lbs	DSB207	50	12	4
QSB209	11-5/8" x 11-1/8" x 6"	10-1/6" x 10" x 6"	8	9 lbs	DSB209	50	18	6
QSB203	17-7/8" x 4-1/8" x 6"	16-1/2" x 3" x 6"	20	15 lbs	DSB203	50	9	3
QSB204	17-7/8" x 6-5/8" x 6"	16-1/2" x 5-1/2" x 6"	20	18 lbs	DSB204	50	15	6
QSB208	17-7/8" x 8-3/8" x 6"	16-1/2" x 7-1/8" x 6"	10	13 lbs	DSB208	50	19	6
QSB210	17-7/8" x 11-1/8" x 6"	16-1/2" x 10" x 6"	8	13 lbs	DSB210	50	29	8
QSB205	23-5/8" x 4-1/8" x 6"	22-1/8" x 3" x 6"	16	15 lbs	DSB205	50	13	4
QSB206	23-5/8" x 6-5/8" x 6"	22-1/8" x 5-1/2" x 6"	8	11 lbs	DSB206	50	21	8
QSB214	23-5/8" x 8-3/8" x 6"	22-1/8" x 7-1/8" x 6"	6	11 lbs	DSB214	50	24	8
QSB216	23-5/8" x 11-1/8" x 6"	22-1/8" x 10" x 6"	6	12 lbs	DSB216	50	35	16

Individual labels are available for all STORE-MORE 6" Shelf Bins. For label Model No. substitute "L" for "Q" in bin Model No. Ctn Qty: 50 Individual Labels



Dividers and Bin Cups

Optional black dividers fit snugly, horizontally across bins to create compartments. Each bin accepts up to 8 dividers. Bins have a slot at the very front allowing the open hopper to be closed off creating even more storage. Bin cups have a raised, slotted label holder for easy parts identification. The entire bin cup may be removed for easy part retrieval. Available in 2 sizes and 2 colors.

Available in: ● Blue ● Yellow

MODEL NO.	OUTSIDE DIMENSIONS L" x W" x H"	CTN QTY	CTN WGT
QBC111	3-1/4" x 1-3/4" x 3"	48	4 lbs
QBC112	5-1/8" x 2-3/4" x 3"	48	7 lbs



STORE-MORE 6" Shelf Bin Steel Shelving Systems - Complete Packages

- Economical small parts storage systems keep parts easily accessible
- Open hopper front bins with label area, provide fast access to stored items
- This all-in-one unit is easy to clean and will not rust or corrode
- Heavy-duty, high grade shelving offers a 400 lb. capacity per shelf
- 36" wide shelving has a smooth powder coat finish
- Bins are available in 4 colors

Available in: ● Blue ● Red ● Yellow ● Clear

MODEL NO.	NO. OF BINS	BIN SIZE L" x W" x H"	SHIP WGT
12" x 36" x 75" 10 Shelf Systems			
1275-201	72 QSB201	11-5/8" x 4-1/8" x 6"	111 lbs
1275-202	45 QSB202	11-5/8" x 6-5/8" x 6"	103 lbs
1275-207	36 QSB207	11-5/8" x 8-3/8" x 6"	100 lbs
1275-209	27 QSB209	11-5/8" x 11-1/8" x 6"	98 lbs
12" x 36" x 39" 5 Shelf Systems			
1239-201	32 QSB201	11-5/8" x 4-1/8" x 6"	56 lbs
1239-202	20 QSB202	11-5/8" x 6-5/8" x 6"	52 lbs
1239-207	16 QSB207	11-5/8" x 8-3/8" x 6"	51 lbs
1239-209	12 QSB209	11-5/8" x 11-1/8" x 6"	50 lbs
18" x 36" x 75" 10 Shelf Systems			
1875-203	72 QSB203	17-7/8" x 4-1/8" x 6"	156 lbs
1875-204	45 QSB204	17-7/8" x 6-5/8" x 6"	141 lbs
1875-208	36 QSB208	17-7/8" x 8-3/8" x 6"	142 lbs
1875-210	27 QSB210	17-7/8" x 11-1/8" x 6"	139 lbs
18" x 36" x 39" 5 Shelf Systems			
1839-203	32 QSB203	17-7/8" x 4-1/8" x 6"	77 lbs
1839-204	20 QSB204	17-7/8" x 6-5/8" x 6"	70 lbs
1839-208	16 QSB208	17-7/8" x 8-3/8" x 6"	71 lbs
1839-210	12 QSB210	17-7/8" x 11-1/8" x 6"	69 lbs

COMPLETE PACKAGES WITH BINS



1839-208



1275-201



1275-202



1875-210



LOWEST PRICE GUARANTEED!

Available in: ● Blue ● Red ● Yellow ● Clear

MODEL NO.	NO. OF BINS	BIN SIZE L" x W" x H"	SHIP WGT
12" x 36" x 26-1/2" 3 Shelf Bench Rack Systems			
QPRHA-201	24 QSB201	11-5/8" x 4-1/8" x 6"	40 lbs
QPRHA-202	15 QSB202	11-5/8" x 6-5/8" x 6"	37 lbs
QPRHA-207	12 QSB207	11-5/8" x 8-3/8" x 6"	36 lbs
QPRHA-209	9 QSB209	11-5/8" x 11-1/8" x 6"	35 lbs
QPRHA-6	Bench Rack Only - No Bins		
12" x 36" x 63-1/2" Single Sided 8 Shelf Rack Systems			
QPRS-201	64 QSB201	11-5/8" x 4-1/8" x 6"	89 lbs
QPRS-202	40 QSB202	11-5/8" x 6-5/8" x 6"	81 lbs
QPRS-207	32 QSB207	11-5/8" x 8-3/8" x 6"	79 lbs
QPRS-209	24 QSB209	11-5/8" x 11-1/8" x 6"	77 lbs
QPRS-6	12" x 36" x 63-1/2" Rack Only - No Bins		
NEW	18" x 36" x 63-1/2" Single Sided 8 Shelf Rack Systems		
QPRS-203	64 QSB203	17-7/8" x 4-1/8" x 6"	126 lbs
QPRS-204	40 QSB204	17-7/8" x 6-5/8" x 6"	114 lbs
QPRS-208	32 QSB208	17-7/8" x 8-3/8" x 6"	120 lbs
QPRS-210	24 QSB210	17-7/8" x 11-1/8" x 6"	117 lbs
QPRS18-6	18" x 36" x 63-1/2" Rack Only - No Bins		
24" x 36" x 63-1/2" Double Sided 16 Shelf Rack Systems			
QPRD-201	128 QSB201	11-5/8" x 4-1/8" x 6"	178 lbs
QPRD-202	80 QSB202	11-5/8" x 6-5/8" x 6"	162 lbs
QPRD-207	64 QSB207	11-5/8" x 8-3/8" x 6"	158 lbs
QPRD-209	48 QSB209	11-5/8" x 11-1/8" x 6"	154 lbs
QPRD-6	24" x 36" x 63-1/2" Rack Only - No Bins		
QDU-00	Mobile Kit - Mobilizes All 24" Deep Double Sided Units		
NEW	36" x 36" x 63-1/2" Double Sided 16 Shelf Rack Systems		
QPRD-203	128 QSB203	17-7/8" x 4-1/8" x 6"	252 lbs
QPRD-204	80 QSB204	17-7/8" x 6-5/8" x 6"	228 lbs
QPRD-208	64 QSB208	17-7/8" x 8-3/8" x 6"	239 lbs
QPRD-210	48 QSB210	17-7/8" x 11-1/8" x 6"	234 lbs
QPRD18-6	36" x 36" x 63-1/2" Rack Only - No Bins		
QDU-18	Mobile Kit - Mobilizes All 36" Deep Double Sided Units		

STORE-MORE 6" Shelf Bin Sloped Shelving Systems - Complete Packages

CLEAR VIEW
AVAILABLE on pg. 29

Pick Racks provide a convenient high density, easy access, sloped shelving system, available as bench units, single and double sided free standing and mobile units. Unit comes complete with STORE-MORE 6"H Shelf Bins. Sloped shelving unit keeps small and medium sized parts easily accessible. Open hopper front bins with label area, provide fast access to stored items. This all-in-one unit is easy to clean and will not rust or corrode. See chart for configurations. Bins are available in 4 colors. One bin color per unit.



QPRHA-209
Bench Pick Rack
250 lb. capacity.

**SLOPED SHELVES, EASY ACCESS,
MOST POPULAR & VERSATILE STORAGE
SYSTEMS SOLD**



QPRD-202 + QDU-00
Mobile, Double Sided Pick Rack
1,000 lb. capacity.



QPRD-207
Double Sided Pick Rack
800 lb. capacity.



QPRS-201
Single Sided Pick Rack
400 lb. capacity.



STORE-MORE 6" Shelf Bin Wire Shelving Systems - Complete Packages

- Easy boltless assembly
- Wire allows air to circulate as well as provides ideal product visibility
- Durable chrome finish ensures years of heavy-duty dependability and service
- All welded shelf construction is supported with architectural wire trusses to provide 800 lb. capacity per shelf
- Bins available in 4 colors

Available in: ● Blue ● Red ● Yellow ● Clear

MODEL NO.	NO. OF BINS	BIN SIZE L" x W" x H"	SHIP WGT
12" x 36" x 74" 9 Shelf Systems			
WR9-201	64 QSB201	11-5/8" x 4-1/8" x 6"	108 lbs
WR9-202	40 QSB202	11-5/8" x 6-5/8" x 6"	100 lbs
WR9-207	32 QSB207	11-5/8" x 8-3/8" x 6"	98 lbs
WR9-209	24 QSB209	11-5/8" x 11-1/8" x 6"	96 lbs
18" x 36" x 74" 9 Shelf Systems			
WR9-203	64 QSB203	17-7/8" x 4-1/8" x 6"	156 lbs
WR9-204	40 QSB204	17-7/8" x 6-5/8" x 6"	142 lbs
WR9-208	32 QSB208	17-7/8" x 8-3/8" x 6"	143 lbs
WR9-210	24 QSB210	17-7/8" x 11-1/8" x 6"	140 lbs
24" x 36" x 74" 9 Shelf Systems			
WR9-205	64 QSB205	23-5/8" x 4-1/8" x 6"	182 lbs
WR9-206	40 QSB206	23-5/8" x 6-5/8" x 6"	171 lbs
WR9-214	32 QSB214	23-5/8" x 8-3/8" x 6"	165 lbs
WR9-216	24 QSB216	23-5/8" x 11-1/8" x 6"	154 lbs

COMPLETE PACKAGES WITH BINS



AVAILABLE on pg. 28

800 lb. CAPACITY PER SHELF



MOBILIZE YOUR WIRE SHELVING

DB - Donut Bumper
Non-marking donut bumper used to protect walls and help cushion impact.

WR-00H (Mobile Kit)*
Set of four swivel polyurethane 5" x 1-1/4" casters, two with brakes. Can be used with all units shown. 1,200 lb. load capacity. *Mobile kits recommended only for shelves 18" and wider.



WR9-202

STORE-MORE 6" Complete Bin Center

Complete bin systems are available with 4 different size bins on a 12"W x 36"L x 39"H unit. This all-purpose bin center is an economical high density storage system that provides easy visibility to stored contents. Bins available in 4 colors.

Available in: ● Blue ● Red ● Yellow ● Clear

MODEL NO.	NO. OF BINS	BIN SIZE L" x W" x H"	SHIP WGT
12" x 36" x 39" 5 Shelf Systems			
WR5-39-1236-201	32 QSB201	11-5/8" x 4-3/8" x 6"	61 lbs
WR5-39-1236-202	20 QSB202	11-5/8" x 6-5/8" x 6"	57 lbs
WR5-39-1236-207	16 QSB207	11-5/8" x 8-3/8" x 6"	56 lbs
WR5-39-1236-209	12 QSB209	11-5/8" x 11-1/8" x 6"	55 lbs



WR5-39-1236-201



WR9-207



WR9-209



LOWEST PRICE GUARANTEED!

12 SIZES AND 4 COLORS AVAILABLE

CLEAR VIEW
AVAILABLE on pg. 30



QSB809

QSB807

QSB802

QSB801

LOW COST, LONG LASTING, UNBREAKABLE, REUSABLE, 8" HIGH BINS

45° Angle

10° Angle



LTR-1253
Clear Label Holder & Insert
Clear label holders and laser label inserts. Clear label holders fit all 8" Shelf Bins. Package of 25.

Divider Label Tab

Divider Label Tabs attach to existing dividers to improve the visibility of bin labels and scanning of barcodes. Package of 6.



DLT-6

Extended Label Holders *simplify identification*

Optional extended label holders are designed for larger bar code scanning. Label holders fit all 8" Shelf Bins.

MODEL NO.	DESCRIPTION	DIMENSIONS W" x H"	CTN QTY
ELH410	10° Angle	4" x 2-1/4"	24
ELH445	45° Angle	4" x 2-1/4"	24

STORE-MAX 8" Shelf Bins

NEW



Our new 8" high bins offer 95% more storage capacity when compared to the standard 4" high bins and 65% more than the 6" high bins. The new STORE-MAX 8"H Bins will truly maximize and organize your space. Manufactured from high density polypropylene, STORE-MAX 8"H Shelf Bins are the industry standard for quality. These bins feature a molded-in label holder, built-in rear hang-lock which allows bins to tilt out for complete access when on shelving. A wide hopper front allows complete access to the contents of the bin. Edges are reinforced for added strength. They are designed for 12", 18" and 24" deep shelf units, racks or standard shelving. Optional dividers are a perfect accessory to subdivide and keep parts separated as needed. Available in 4 colors. See **pg. 30** to order Clear Bins.

Available in: ● Blue ● Red ● Yellow ● Clear

MODEL NO.	OUTSIDE DIMENSIONS L" x W" x H"	INSIDE DIMENSIONS L" x W" x H"	CTN QTY	CTN WGT	DIVIDER	CTN QTY	NO. OF BIN CUPS PER BIN QBC111	CTN QTY
QSB801	11-5/8" x 4-3/8" x 8"	10-1/6" x 3" x 8"	36	27 lbs	DSB801	50	6	2
QSB802	11-5/8" x 6-5/8" x 8"	10-1/6" x 5-1/2" x 8"	30	26 lbs	DSB802	50	9	4
QSB807	11-5/8" x 8-3/8" x 8"	10-1/6" x 7-1/8" x 8"	20	21 lbs	DSB807	50	12	4
QSB809	11-5/8" x 11-1/8" x 8"	10-1/6" x 10" x 8"	8	11 lbs	DSB809	50	18	6
QSB803	17-7/8" x 4-3/8" x 8"	16-1/2" x 3" x 8"	20	22 lbs	DSB803	50	9	3
QSB804	17-7/8" x 6-5/8" x 8"	16-1/2" x 5-1/2" x 8"	20	26 lbs	DSB804	50	15	6
QSB808	17-7/8" x 8-3/8" x 8"	16-1/2" x 7-1/8" x 8"	10	15 lbs	DSB808	50	19	6
QSB810	17-7/8" x 11-1/8" x 8"	16-1/2" x 10" x 8"	8	17 lbs	DSB810	50	29	8
QSB805	23-5/8" x 4-3/8" x 8"	22-1/8" x 3" x 8"	16	24 lbs	DSB805	50	13	4
QSB806	23-5/8" x 6-5/8" x 8"	22-1/8" x 5-1/2" x 8"	8	13 lbs	DSB806	50	21	8
QSB814	23-5/8" x 8-3/8" x 8"	22-1/8" x 7-1/8" x 8"	6	12 lbs	DSB814	50	24	8
QSB816	23-5/8" x 11-1/8" x 8"	22-1/8" x 10" x 8"	6	14 lbs	DSB816	50	35	16

Individual labels are available for all STORE-MAX 8" Shelf Bins. For label Model No. substitute "L" for "Q" in bin Model No. Ctn Qty: 50 Individual Labels



Dividers and Bin Cups

Optional black dividers fit snugly, horizontally across bins to create compartments. Each bin accepts up to 7 dividers.

Bin cups have a raised, slotted label holder for easy parts identification. The entire bin cup may be removed for easy part retrieval. Available in 2 sizes and 2 colors.

Available in: ● Blue ● Yellow

MODEL NO.	OUTSIDE DIMENSIONS L" x W" x H"	CTN QTY	CTN WGT
QBC111	3-1/4" x 1-3/4" x 3"	48	4 lbs
QBC112	5-1/8" x 2-3/4" x 3"	48	7 lbs



STORE-MAX 8" Shelf Bin Steel Shelving Systems - Complete Packages



- Economical small parts storage systems keep parts easily accessible
- Open hopper front bins with label area, provide fast access to stored items
- This all-in-one unit is easy to clean and will not rust or corrode
- Heavy-duty, high grade shelving offers a 400 lb. capacity per shelf
- 36" wide shelving has a smooth powder coat finish
- Bins are available in 4 colors

Available in: ● Blue ● Red ● Yellow ● Clear

MODEL NO.	NO. OF BINS	BIN SIZE L" x W" x H"	SHIP WGT
12" x 36" x 75" 8 Shelf Systems			
1275-SB801	56 QSB801	11-5/8" x 4-3/8" x 8"	111 lbs
1275-SB802	35 QSB802	11-5/8" x 6-5/8" x 8"	103 lbs
1275-SB807	28 QSB807	11-5/8" x 8-3/8" x 8"	100 lbs
1275-SB809	21 QSB809	11-5/8" x 11-1/8" x 8"	98 lbs
12" x 36" x 39" 4 Shelf Systems			
1239-SB801	24 QSB801	11-5/8" x 4-3/8" x 8"	56 lbs
1239-SB802	15 QSB802	11-5/8" x 6-5/8" x 8"	52 lbs
1239-SB807	12 QSB807	11-5/8" x 8-3/8" x 8"	51 lbs
1239-SB809	9 QSB809	11-5/8" x 11-1/8" x 8"	50 lbs
16" x 36" x 75" 8 Shelf Systems			
1875-SB803	56 QSB803	17-7/8" x 4-3/8" x 8"	156 lbs
1875-SB804	35 QSB804	17-7/8" x 6-5/8" x 8"	141 lbs
1875-SB808	28 QSB808	17-7/8" x 8-3/8" x 8"	142 lbs
1875-SB810	21 QSB810	17-7/8" x 11-1/8" x 8"	139 lbs
18" x 36" x 39" 4 Shelf Systems			
1839-SB803	24 QSB803	17-7/8" x 4-3/8" x 8"	77 lbs
1839-SB804	15 QSB804	17-7/8" x 6-5/8" x 8"	70 lbs
1839-SB808	12 QSB808	17-7/8" x 8-3/8" x 8"	71 lbs
1839-SB810	9 QSB810	17-7/8" x 11-1/8" x 8"	69 lbs

COMPLETE PACKAGES WITH BINS



AVAILABLE on pg. 31



1275-SB801

400 lb. CAPACITY PER SHELF



1239-SB807



1275-SB802



1275-SB809



LOWEST PRICE GUARANTEED!



WR8-801

COMPLETE PACKAGES WITH BINS

NEW

STORE-MAX 8" Shelf Bin Wire Shelving Systems - Complete Packages

- Easy boltless assembly
- Wire allows air to circulate as well as provides ideal product visibility
- Durable chrome finish ensures years of heavy-duty dependability and service
- All welded shelf construction is supported with architectural wire trusses to provide 800 lb. capacity per shelf
- Bins are available in 4 colors



AVAILABLE on pg. 31

800 lb. CAPACITY PER SHELF



MOBILIZE YOUR WIRE SHELVING

DB - Donut Bumper

Non-marking donut bumper used to protect walls and help cushion impact.

WR-00H (Mobile Kit)*

Set of four swivel polyurethane 5" x 1-1/4" casters, two with brakes. Can be used with all units shown. 1,200 lb. load capacity. *Mobile kits recommended only for shelves 18" and wider.

Available in: ● Blue ● Red ● Yellow ● Clear

MODEL NO.	NO. OF BINS	BIN SIZE L" x W" x H"	SHIP WGT
12" x 36" x 74" 8 Shelf Systems			
WR8-801	49 QSB801	11-5/8" x 4-3/8" x 8"	100 lbs
WR8-802	35 QSB802	11-5/8" x 6-5/8" x 8"	103 lbs
WR8-807	28 QSB807	11-5/8" x 8-3/8" x 8"	102 lbs
WR8-809	21 QSB809	11-5/8" x 11-1/8" x 8"	101 lbs
18" x 36" x 74" 8 Shelf Systems			
WR8-803	49 QSB803	17-7/8" x 4-3/8" x 8"	150 lbs
WR8-804	35 QSB804	17-7/8" x 6-5/8" x 8"	142 lbs
WR8-808	28 QSB808	17-7/8" x 8-3/8" x 8"	138 lbs
WR8-810	21 QSB810	17-7/8" x 11-1/8" x 8"	141 lbs
24" x 36" x 74" 8 Shelf Systems			
WR8-805	49 QSB805	23-5/8" x 4-3/8" x 8"	194 lbs
WR8-806	35 QSB806	23-5/8" x 6-5/8" x 8"	177 lbs
WR8-814	28 QSB814	23-5/8" x 8-3/8" x 8"	176 lbs
WR8-816	21 QSB816	23-5/8" x 11-1/8" x 8"	169 lbs



WR8-802



WR8-809

NEW

STORE-MAX 8" Complete Bin Center

Complete bin systems are available with 4 different size bins on a 12"W x 36"L x 39"H unit. This all-purpose bin center is an economical high density storage system that provides easy visibility to stored contents. Bins are available in 4 colors.

Available in: ● Blue ● Red ● Yellow ● Clear

MODEL NO.	NO. OF BINS	BIN SIZE L" x W" x H"	SHIP WGT
12" x 36" x 39" 4 Shelf Systems			
WR4-39-1236-801	21 QSB801	11-5/8" x 4-3/8" x 8"	80 lbs
WR4-39-1236-802	15 QSB802	11-5/8" x 6-5/8" x 8"	78 lbs
WR4-39-1236-807	12 QSB807	11-5/8" x 8-3/8" x 8"	77 lbs
WR4-39-1236-809	9 QSB809	11-5/8" x 11-1/8" x 8"	77 lbs



WR4-39-1236-807



Super Tuff Euro Drawers



Super Tuff Euro Drawers are available in nine sizes and four colors and are designed for efficient organization of heavy parts, supplies, tools or equipment. Super Tuff Euro Drawers are injection molded from virgin grade high impact polystyrene and are virtually unbreakable. These heavy-duty drawers can be used on Quantum's open and closed shelf units and pick racks. Available in 4 colors.

Available in: ● Blue ● Red ● Yellow ● Gray

MODEL NO.	OUTSIDE DIMENSIONS L" x W" x H"*	CTN QTY	CTN WGT	NUMBER OF DIVIDER SLOTS	DIVIDER	CTN QTY
QED401	11-5/8" x 5-9/16" x 2-1/8"	24	17 lbs	8	DIV401	4
QED501	11-5/8" x 3-3/4" x 4-5/8"	24	19 lbs	8	DIV501/604	4
QED601	11-5/8" x 5-9/16" x 4-5/8"	24	24 lbs	8	DIV6123	4
QED701	11-5/8" x 8-3/8" x 4-5/8"	24	31 lbs	8	DIV701/606	4
QED801	11-5/8" x 11-1/8" x 4-5/8"	12	19 lbs	8	DIV801	4
QED604	17-5/8" x 3-3/4" x 4-5/8"	24	29 lbs	15	DIV501/604	4
QED602	17-5/8" x 5-9/16" x 4-5/8"	24	32 lbs	13	DIV6123	4
QED606	17-5/8" x 8-3/8" x 4-5/8"	24	46 lbs	13	DIV701/606	4
QED603	23-7/8" x 5-9/16" x 4-5/8"	12	25 lbs	18	DIV6123	4

* Rear tab adds an additional 3/8" to rear height.

PERFORMANCE FEATURES:

- Available in 9 sizes
- Bins are injection molded from a virgin grade high impact polystyrene and are virtually unbreakable
- Drawers are completely waterproof
- Drawers are oil and chemical resistant
- Smooth front curved pull handle has ample room for pressure sensitive identification labels or bar code
- Front handle has 3/4" opening for convenient easy gripping
- Full width back ledge ensures spill free use
- Optional dividers are full height for extra holding power and prevents mixing of parts
- Available in four colors ideal for color coding inventory: Blue, Yellow, Red and Gray

9 SIZES AND 4 COLORS AVAILABLE

Full width back ledge ensures spill free use when used on shelving



Multiple divider grooves allow for customized and optimal storage

Multiple molded-in divider slots

Smooth front curved pull handle has ample room for pressure sensitive identification labels or bar codes

Front handle has 3/4" opening for convenient easy gripping

Injection molded from virgin grade high impact polystyrene and are virtually unbreakable

AL-23
2" x 3-1/2"
Adhesive clear label holder & inserts. Fits all sizes of drawers 5-9/16" W and wider except QED401. Package of 24 (Sold separately)

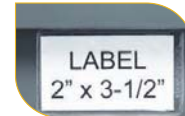

12" Deep Euro Drawers

HEAVY-DUTY DRAWERS VIRTUALLY UNBREAKABLE



18" Deep Euro Drawers

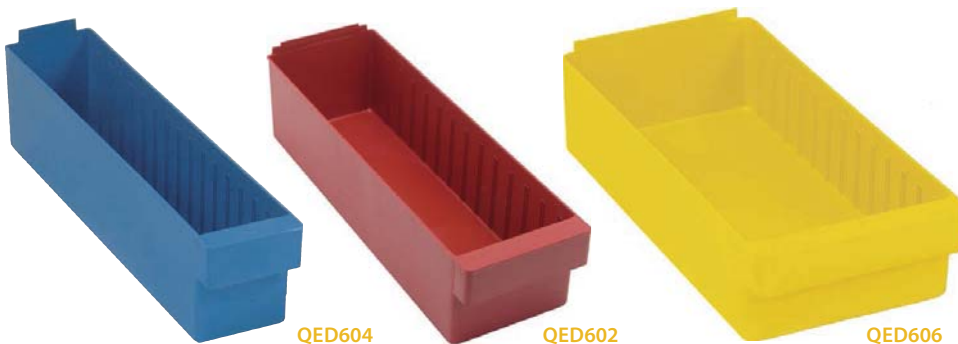

24" Deep Euro Drawer





LOWEST PRICE GUARANTEED!



CL1875-624
Closed Unit



1239-601
Open Unit
(No side or back panels)

Open and Closed Shelving Systems with Super Tuff Drawers
Complete Packages

Save time locating parts using our tough Euro Drawers with our sturdy open or closed steel shelving. 36" wide x 75" or 39" high units offer heavy-duty, high grade shelving with a 400 lb. capacity per shelf. Closed shelving provides a dust free environment for stored parts. Shelving is Gray, drawers are available in 4 colors.

Available in: ● Blue ● Yellow ● Red ● Gray

CLOSED UNITS		OPEN UNITS		
MODEL NO.	MODEL NO.	BIN SIZE L" x W" x H"	NO. OF BINS	SHIP WGT
12" x 36" x 75" 13 Shelf Systems				
CL1275-401*	1275-401*	11-5/8" x 5-9/16" x 2-5/8"	108 QED401	231 lbs
CL1275-501	1275-501	11-5/8" x 3-3/4" x 4-5/8"	108 QED501	215 lbs
CL1275-601	1275-601	11-5/8" x 5-9/16" x 4-5/8"	72 QED601	192 lbs
CL1275-701	1275-701	11-5/8" x 8-3/8" x 4-5/8"	48 QED701	171 lbs
CL1275-801	1275-801	11-5/8" x 11-1/8" x 4-5/8"	36 QED801	189 lbs
CL1275-000	1275-000	Steel Unit Only - No Bins		129 lbs
18" x 36" x 75" 13 Shelf Systems				
CL1875-602	1875-602	17-7/8" x 5-9/16" x 4-5/8"	72 QED602	266 lbs
CL1875-604	1875-604	17-7/8" x 3-3/4" x 4-5/8"	108 QED604	287 lbs
CL1875-624	1875-624	17-7/8" x 5-9/16" x 4-5/8"	36 QED602	276 lbs
		17-7/8" x 3-3/4" x 4-5/8"	54 QED604	
CL1875-606	1875-606	17-7/8" x 8-3/8" x 4-5/8"	48 QED606	237 lbs
CL1875-000	1875-000	Steel Unit Only - No Bins		167 lbs
24" x 36" x 75" 13 Shelf Systems				
CL2475-603	2475-603	23-7/8" x 5-9/16" x 4-5/8"	72 QED603	360 lbs
12" x 36" x 39" 7 Shelf Systems				
CL1239-401**	1239-401**	11-5/8" x 5-9/16" x 2-5/8"	54 QED401	121 lbs
CL1239-601	1239-601	11-5/8" x 5-9/16" x 4-5/8"	36 QED601	99 lbs
CL1239-000	1239-000	Steel Unit Only - No Bins		70 lbs
18" x 36" x 39" 7 Shelf Systems				
CL1839-602	1839-602	17-7/8" x 5-9/16" x 4-5/8"	36 QED602	139 lbs
CL1839-604	1839-604	17-7/8" x 3-3/4" x 4-5/8"	54 QED604	155 lbs
CL1839-624	1839-624	17-7/8" x 5-9/16" x 4-5/8"	18 QED602	147 lbs
		3-3/4" x 4-5/8"	27 QED604	
CL1839-000	1839-000	Steel Unit Only - No Bins		89 lbs
24" x 36" x 39" 7 Shelf Systems				
CL2439-603	2439-603	23-7/8" x 5-9/16" x 4-5/8"	36 QED603	198 lbs

* Unit includes 19 shelves. ** Unit includes 10 shelves.

**HIGH DENSITY, HEAVY-DUTY,
DUST FREE & SECURE STORAGE**

**COMPLETE PACKAGES
WITH BINS**

**MORE ECONOMICAL SOLUTION
COMPARED TO HIGHER COST STEEL
DRAWER UNITS**



Euro Drawer Sloped Shelving Systems - Complete Packages

COMPLETE PACKAGES WITH BINS

Sturdy steel racks with Super Tuff Euro Drawers create an efficient flow rack. Sloped shelving provides easy access to stored items. Drawers can be removed from racks easily. These gray baked enamel, free standing racks assemble easily. Mobile unit has a 1,000 lb. capacity and is equipped with 2 swivel, 2 rigid casters. Drawers are available in 4 colors. One bin color per system.



QPRHA-601
Bench Pick Rack
250 lb. capacity.

Available in: ● Blue ● Yellow ● Red ● Gray

MODEL NO.	NO. OF BINS	BIN SIZE L" x W" x H"	SHIP WGT
12-1/2" x 36" x 23" 3 Shelf Bench Rack Systems			
QPRHA-501	27 QED501	11-5/8" x 3-3/4" x 4-5/8"	48
QPRHA-601	18 QED601	11-5/8" x 5-9/16" x 4-5/8"	42
QPRHA-701	12 QED701	11-5/8" x 8-3/8" x 4-5/8"	42
	9 QED501	11-5/8" x 3-3/4" x 4-5/8"	
QPRHA-567	6 QED601	11-5/8" x 5-9/16" x 4-5/8"	44
	4 QED701	11-5/8" x 8-3/8" x 4-5/8"	
12" x 36" x 60" Single Sided 8 Shelf Rack Systems			
QPRS-501	72 QED501	11-5/8" x 3-3/4" x 4-5/8"	110
QPRS-601	48 QED601	11-5/8" x 5-9/16" x 4-5/8"	91
QPRS-701	32 QED701	11-5/8" x 8-3/8" x 4-5/8"	95
QPRS-801	24 QED801	11-5/8" x 11-1/8" x 4-5/8"	93
	18 QED501	11-5/8" x 3-3/4" x 4-5/8"	
	12 QED601	11-5/8" x 5-9/16" x 4-5/8"	
QPRS-5678	8 QED701	11-5/8" x 8-3/8" x 4-5/8"	99
	6 QED801	11-5/8" x 11-1/8" x 4-5/8"	
NEW 18" x 36" x 60" Single Sided 8 Shelf Rack Systems			
QPRS-604	72 QED604	17-7/8" x 3-3/4" x 4-5/8"	165
QPRS-602	48 QED602	17-7/8" x 5-9/16" x 4-5/8"	142
QPRS-606	32 QED606	17-7/8" x 8-3/8" x 4-5/8"	139
24" x 36" x 60" Double Sided 16 Shelf Rack Systems			
QPRD-501	144 QED501	11-5/8" x 3-3/4" x 4-5/8"	220
QPRD-601	96 QED601	11-5/8" x 5-9/16" x 4-5/8"	190
QPRD-701	64 QED701	11-5/8" x 8-3/8" x 4-5/8"	189
QPRD-801	48 QED801	11-5/8" x 11-1/8" x 4-5/8"	186
	36 QED501	11-5/8" x 3-3/4" x 4-5/8"	
	24 QED601	11-5/8" x 5-9/16" x 4-5/8"	
QPRD-5678	16 QED701	11-5/8" x 8-3/8" x 4-5/8"	197
	12 QED801	11-5/8" x 11-1/8" x 4-5/8"	
QDU-00	Mobile Kit - Mobilizes All 24" Deep Double Sided Units		29
NEW 36" x 36" x 60" Double Sided 16 Shelf Rack Systems			
QPRD-604	144 QED604	17-7/8" x 3-3/4" x 4-5/8"	330
QPRD-602	96 QED602	17-7/8" x 5-9/16" x 4-5/8"	284
QPRD-606	64 QED606	17-7/8" x 8-3/8" x 4-5/8"	279
QDU-18	Mobile Kit - Mobilizes All 36" Deep Double Sided Units		39

SLOPED SHELVES, EASY ACCESS, MOST POPULAR & VERSATILE STORAGE SYSTEMS SOLD



QPRS-601
Single Sided Pick Rack
400 lb. capacity.

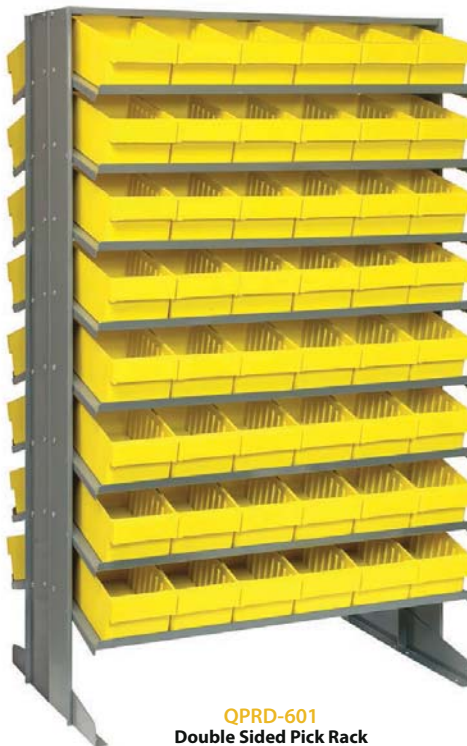

QPRD-601
Double Sided Pick Rack
800 lb. capacity.



QPRD-601 + QDU-00
Mobile, Double Sided Pick Rack
1,000 lb. capacity.



LOWEST PRICE GUARANTEED!

7 SIZES AND 4 COLORS AVAILABLE

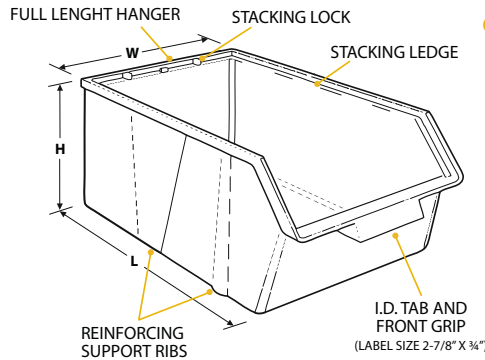
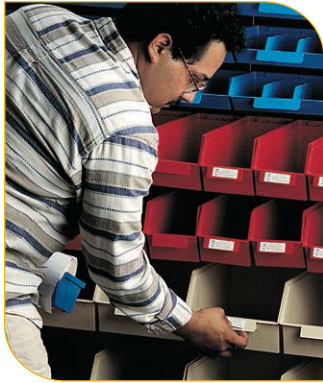
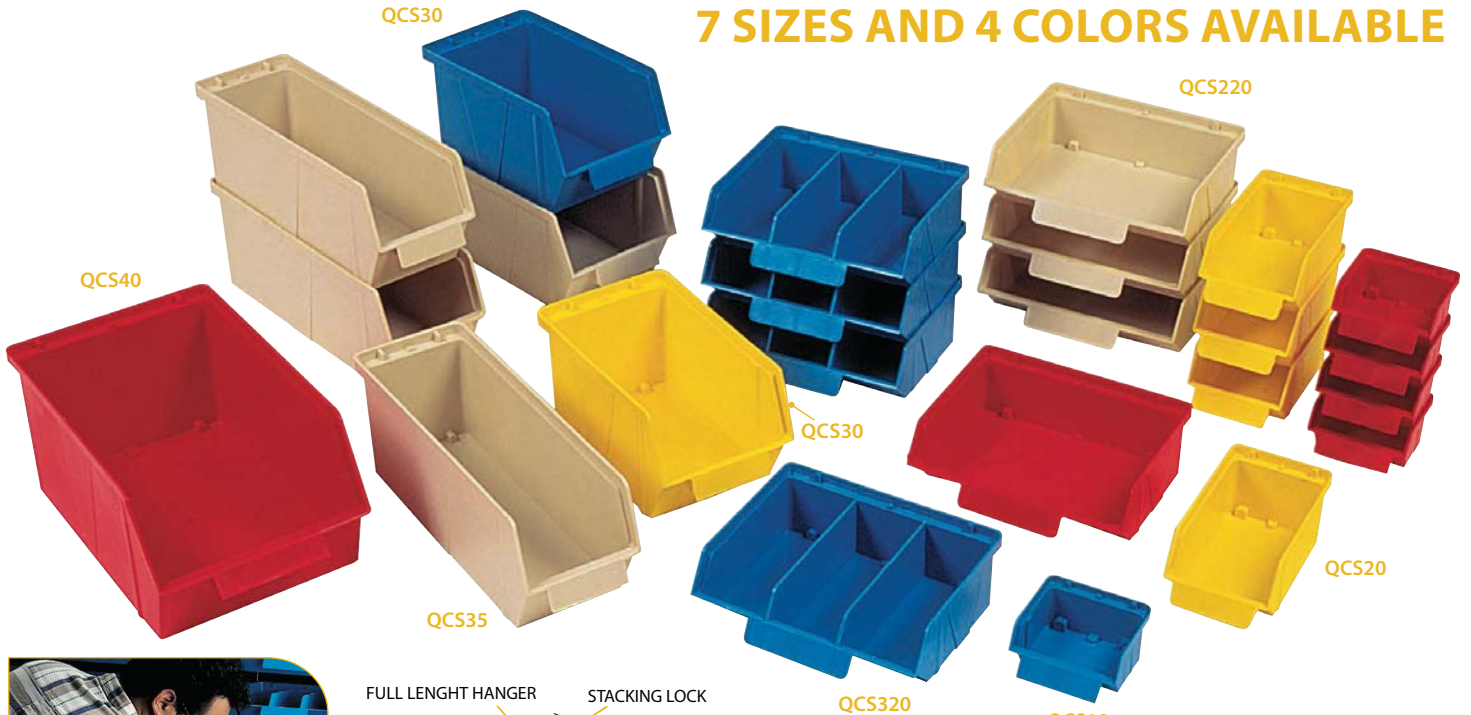

The Open Hopper Stack and Lock Bin



These Classic bins are all purpose open hoppers, made from high impact polystyrene. They will stack and lock on one another, and hang on Quantum louvered panels, rails and carts to form an efficient system for storing and moving parts. They can also be used on Quantum Shelf Units and standard shelving. Available in 4 colors.

Available in: ● Blue ● Yellow ● Red ● Ivory

MODEL NO.	OUTSIDE DIMENSIONS L" x W" x H"	CTN QTY	CTN WGT
QCS10	4" x 3-7/8" x 2"	48	7 lbs
QCS20	7" x 3-7/8" x 2-7/8"	48	13 lbs
QCS220	7" x 8-7/8" x 2-7/8"	24	13 lbs
QCS320*	7" x 8-7/8" x 2-7/8"	24	16 lbs
QCS30	10-1/4" x 5-7/8" x 5-1/8"	12	11 lbs
QCS35	14" x 4-5/8" x 4-7/8"	12	14 lbs
QCS40	13-1/2" x 8-1/8" x 6-1/8"	8	12 lbs

* Three divided sections - each section is 2-5/8"W

COMPLETE PACKAGE WITH BINS

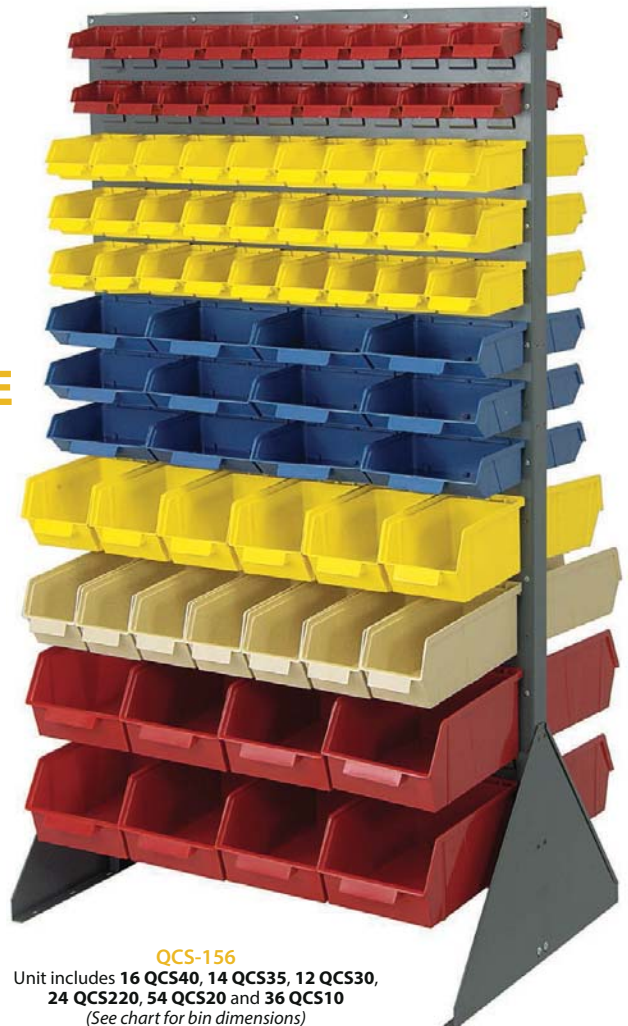

MODEL NO.	NO. OF BINS
QCS-156	156 Bins

Unit includes **16 QCS40, 14 QCS35, 12 QCS30, 24 QCS220, 54 QCS20** and **36 QCS10**
(See chart for bin dimensions)

PERFORMANCE FEATURES:

- Available in 7 unique sizes
- Front identification tab ideal for gripping and handling
- Reinforced ribs - add strength and prevent spreading
- Full length rear hanger for added support and hanging capability

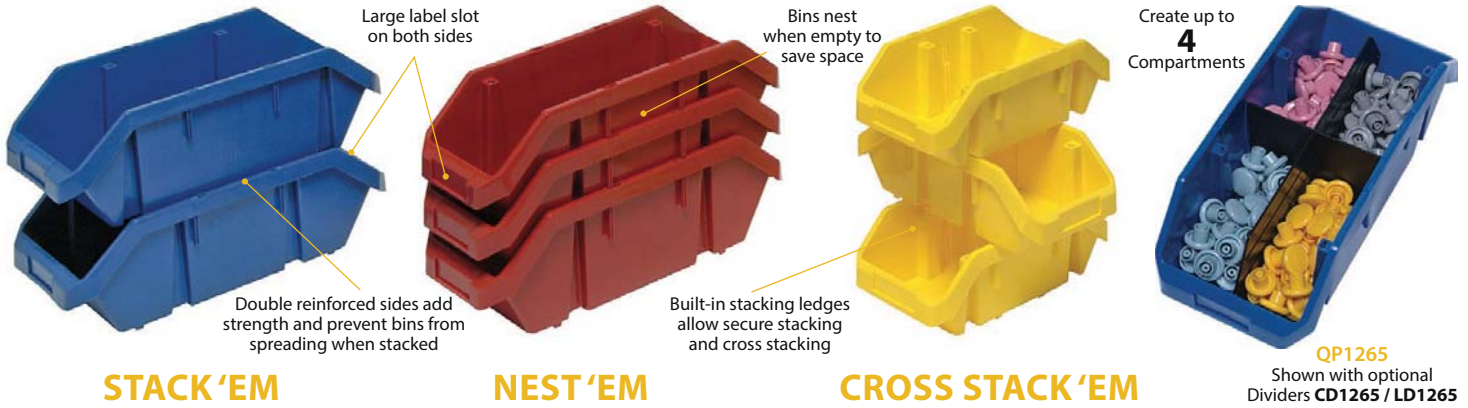

STACK 'EM

NEST 'EM

CROSS STACK 'EM

QP1265
Shown with optional
Dividers **CD1265 / LD1265**

QuickPick Bin



6 SIZES AND 3 COLORS AVAILABLE

Dividers

These heavy-duty, polypropylene storage bins provide an open hopper front and back, allowing double access to stored parts. Bins stack one on top of the other, both vertically and cross-wise, and nest when empty for space efficiency. Optional dividers may be used front to back, side to side or both at the same time, dividing the bin into four sections. A molded in label holder on both the front and back of the bin allows for easy parts identification. Bins can be used on standard metal or wire shelving as well as on desks, bench tops or work stations. Available in 6 sizes and in 3 colors.



LTR-1253
Clear Label Holder & Insert
Clear label holders and laser label inserts. Fits all QuickPick Bins. Package of 25.

Optional dividers may be used front to back, side to side or both at the same time, dividing the bin into four sections.

Available in: ● Blue ● Red ● Yellow

MODEL NO.	DIMENSIONS L" x W" x H"	CTN QTY	CTN WGT	CROSS DIVIDER	CTN QTY	LENGTH DIVIDER	CTN QTY	CLEAR LABEL HOLDER & INSERT
QP965	9-1/2" x 6-5/8" x 5"	20	15 lbs	CD965	10	LD965	10	LTR-1253
QP1265	12-1/2" x 6-5/8" x 5"	20	19 lbs	CD1265	10	LD1265	10	LTR-1253
QP1285	12-1/2" x 8-3/8" x 5"	20	22 lbs	CD1285	10	LD1285	10	LTR-1253
QP1496	14" x 9-1/4" x 6-1/2"	20	26 lbs	CD1496	10	LD1496	10	LTR-1253
QP1867	18-1/2" x 6-5/8" x 7"	10	16 lbs	CD1867	10	LD1867	10	LTR-1253
QP1887	18-1/2" x 8-3/8" x 7"	10	18 lbs	CD1887	10	LD1887	10	LTR-1253

**THE MOST VERSATILE
BIN IN THE INDUSTRY WITH
DOUBLE SIDED ACCESS**



WRC3-1836-1867

QuickPick Bin Mobile Wire Cart

Carts are available in a 2 or 3 shelf configuration complete with four casters (all swivel and two with brakes). Overall dimensions: 18"W x 36"L x 37-1/2"H. Mobile cart is easy to assemble. Bins are available in 3 colors. One color per cart.

Available in: ● Blue ● Red ● Yellow

MODEL NO.	NO. OF BINS	BIN DIMENSIONS L" x W" x H"	SHIP WGT
WRC2-1836-1265	10	12-1/2" x 6-5/8" x 5"	49 lbs
WRC3-1836-1265	15	12-1/2" x 6-5/8" x 5"	64 lbs
WRC2-1836-1285	8	12-1/2" x 8-3/8" x 5"	48 lbs
WRC3-1836-1285	12	12-1/2" x 8-3/8" x 5"	63 lbs
WRC2-1836-1867	10	18-1/2" x 6-5/8" x 7"	55 lbs
WRC3-1836-1867	15	18-1/2" x 6-5/8" x 7"	73 lbs
WRC2-1836-1887	8	18-1/2" x 8-3/8" x 7"	54 lbs
WRC3-1836-1887	12	18-1/2" x 8-3/8" x 7"	72 lbs

Heavy-Duty Wire Shelving with QuickPick Bins
Complete Packages

These unique shelving packages provide "double" access to stored parts. QuickPick Bins allow two users to access stored product at the same time! This ergonomic, space efficient work station is the ultimate space saver! Shelving systems measure 18"W x 36"L x 74"H and may be ordered with or without a mobile kit. These heavy-duty systems offer an 800 lb. capacity per shelf. Optional dividers may be used front to back, side to side or both at the same time, dividing the bin into four sections. See chart above for ordering instructions. A molded in label holder on both the front and back of the bin allows for easy part identification. Bins are available in 3 colors.

Available in: ● Blue ● Red ● Yellow

MODEL NO.	NO. OF BINS	DIMENSIONS L" x W" x H"	SHIP WGT
W7-12-30	30	12-1/2" x 6-5/8" x 5"	110 lbs
W7-12-26	10 16	12-1/2" x 6-5/8" x 5" 12-1/2" x 8-3/8" x 5"	107 lbs
W7-12-28	20 8	12-1/2" x 6-5/8" x 5" 12-1/2" x 8-3/8" x 5"	109 lbs
W7-12-24	24	12-1/2" x 8-3/8" x 5"	106 lbs
W7-14-18	18	14" x 9-1/4" x 6-1/2"	105 lbs
W7-18-30	30	18-1/2" x 6-5/8" x 7"	128 lbs
W7-18-26	10 16	18-1/2" x 6-5/8" x 7" 18-1/2" x 8-3/8" x 7"	125 lbs
W7-18-28	20 8	18-1/2" x 6-5/8" x 7" 18-1/2" x 8-3/8" x 7"	127 lbs
W7-18-24	24	18-1/2" x 8-3/8" x 7"	124 lbs
Mobile Kit			
WR-00H	Mobilizes Wire Shelving Unit		14 lbs



W7-12-26

**800 lb.
CAPACITY PER SHELF**



LOWEST PRICE GUARANTEED!

9 SIZES AND 4 COLORS AVAILABLE



Dividers

Containers can be divided by length and/or width allowing a subdivision down to a 1-1/8" square compartment size. Available in Gray.



Snap On Covers

Snap on covers protect contents from damage or dust during shipping and storage.



Clear Label Holder

Fits any size container. Three sizes to choose from.



Dividable Grid Containers



Heavy duty Dividable Grid Containers can be used in industrial, commercial, electronic and health care industries for storage, assembly, fabrication and distribution applications. These containers offer the safest and most efficient method for compartmentalizing and protecting small to medium sized parts. Dividers allow you to customize the container's interior to meet your exact needs. Containers and covers are available in 4 colors.

Available in: ● Blue ● Gray ● Red ● Clear

MODEL NO.	OUTSIDE DIMENSIONS L" x W" x H"	INSIDE DIMENSIONS L" x W" x H"	CTN QTY	CTN WGT	LONG DIVIDER	CTN QTY	SHORT DIVIDER	CTN QTY	COVER	CTN QTY
DG91035	10-7/8" x 8-1/4" x 3-1/2"	9-3/16" x 6-9/16" x 3"	20	24 lbs	DL91035	6	DS91035	6	COV91000	10
DG91050	10-7/8" x 8-1/4" x 5"	9-3/16" x 6-9/16" x 4-1/2"	20	32 lbs	DL91050	6	DS91050	6	COV91000	10
DG92035	16-1/2" x 10-7/8" x 3-1/2"	14-7/8" x 9-1/4" x 3"	12	23 lbs	DL92035	6	DS92035	6	COV92000	4
DG92060	16-1/2" x 10-7/8" x 6"	14-7/8" x 9-1/4" x 5-1/2"	8	20 lbs	DL92060	6	DS92060	6	COV92000	4
DG92080	16-1/2" x 10-7/8" x 8"	14-7/8" x 9-1/4" x 7-1/2"	8	27 lbs	DL92080	6	DS92080	6	COV92000	4
DG93030	22-1/2" x 17-1/2" x 3"	20-5/8" x 15-5/8" x 2-1/2"	6	20 lbs	DL93030	6	DS93030	6	COV93000	3
DG93060	22-1/2" x 17-1/2" x 6"	20-5/8" x 15-5/8" x 5-1/2"	3	16 lbs	DL93060	6	DS93060	6	COV93000	3
DG93080	22-1/2" x 17-1/2" x 8"	20-5/8" x 15-5/8" x 7-1/2"	3	19 lbs	DL93080	6	DS93080	6	COV93000	3
DG93120	22-1/2" x 17-1/2" x 12"	20-5/8" x 15-5/8" x 11-1/2"	3	23 lbs	DL93120	6	DS93120	6	COV93000	3



AVAILABLE on pg. 32



Clear Dust Cover Acrylic Inlays

Clear Acrylic Dust Cover Inlays keep stored items visible while protecting against airborne dust and other contaminants. Cover lays inside on recessed rim of container.

MODEL NO.	FITS BIN MODEL NO.	CTN QTY
DDC91000CL	DG91035, DG91050	10
DDC92000CL	DG92035, DG92060, DG92080	4
DDC93000CL	DG93030, DG93060, DG93080, DG93120	3



Clear Label Holders

MODEL NO.	DIMENSIONS H" x W"	FITS BIN MODEL NO.	CTN QTY
LBL2X8	2" x 8"	DG91035, DG92035, DG93030	6
LBL3X5	3" x 5"	DG91050, DG92060, DG93060	6
LBL5X8	5" x 8"	DG92080, DG93080, DG93120	6

Clear Covers

MODEL NO.	FITS BIN MODEL NO.	CTN QTY
COV91000CL	DG91035, DG91050	10
COV92000CL	DG92035, DG92060, DG92080	4
COV93000CL	DG93030, DG93060, DG93080, DG93120	3



9 SIZES AND 3 COLORS AVAILABLE



snh010

All nine sizes of totes have ability to use the optional 3" x 5" clear label holder. It securely attaches to tote with or without lid for easy part identification.



AL-35

3" x 5" Clear Adhesive Label Holder & Inserts attaches securely to container for easy part identification. Package of 24.



Optional lid snaps on tightly and securely to protect container contents. As pictured, lids can be fastened and locked for added security.

Genuine stack and nest totes



These heavy-duty, tough, and dependable stack and nest totes are the ultimate reusable container for storing and transporting your valuable items in any application. These proven containers are available in nine sizes and three colors for efficiency and inventory control.

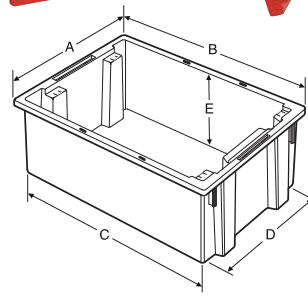

Available in: ● Blue ● Gray ● Red

MODEL NO.	OUTSIDE DIMENSIONS L" x W" x H"	A	B	INSIDE DIMENSIONS			CAPACITY (CU FT)	CTN QTY	CTN WGT	LID	CTN QTY	
				C	D	E						
snt180	18" x 11" x 6"	10"	16"	15-1/4"	9-3/8"	5-7/8"	0.50	6	12 lbs	LID181	6	
snt185	18" x 11" x 9"	10"	16"	15-1/8"	9-1/8"	8-7/8"	0.76	6	15 lbs	LID181	6	
snt190	19-1/2" x 15-1/2" x 10"	14-1/2"	17"	16"	13-1/4"	9-7/8"	1.20	6	23 lbs	LID191	6	
snt195	19-1/2" x 15-1/2" x 13"	14-1/2"	17"	15-7/8"	13-3/8"	12-7/8"	1.70	6	26 lbs	LID191	6	
snt200	19-1/2" x 13-1/2" x 8"	12-3/8"	17-7/8"	16-3/8"	11-1/2"	7-7/8"	0.80	6	19 lbs	LID201	6	
snt225	23-1/2" x 19-1/2" x 10"	18-1/4"	20-7/8"	19-3/8"	16-7/8"	9-7/8"	2.00	3	18 lbs	LID231	3	
snt230	23-1/2" x 19-1/2" x 13"	18-1/8"	20-7/8"	19-1/2"	16-7/8"	12-7/8"	2.60	3	22 lbs	LID231	3	
snt240	23-1/2" x 15-1/2" x 12"	14-1/4"	20-7/8"	19-5/8"	13"	11-7/8"	1.70	3	18 lbs	LID241	3	
snt300	29-1/2" x 19-1/2" x 15"	18-1/4"	26-5/8"	25-1/8"	16-5/8"	14-7/8"	3.70	3	31 lbs	LID301	3	
snh010	Clear Label Holder - 3" x 5" (Fits all tote sizes)								6	1 lb	-	-

LIGHTWEIGHT, HEAVY-DUTY HDPE SIMPLE SNAP-TOGETHER DESIGN

Polymer Dunnage Rack

MODEL NO.	DIMENSIONS W" x L" x H"	SHIP WGT
Ventilated Top		
362412DPP	24" x 36" x 12"	13 lbs
363612DPP	36" x 36" x 12"	22 lbs
482412DPP	24" x 48" x 12"	19 lbs
662412DPP	24" x 66" x 12"	23 lbs
663612DPP	36" x 66" x 12"	37 lbs
962412DPP	24" x 96" x 12"	34 lbs
963612DPP	36" x 96" x 12"	53 lbs
Solid Top		
362412DPS	24" x 36" x 12"	17 lbs
363612DPS	36" x 36" x 12"	26 lbs
482412DPS	24" x 48" x 12"	21 lbs
662412DPS	24" x 66" x 12"	28 lbs
663612DPS	36" x 66" x 12"	49 lbs
962412DPS	24" x 96" x 12"	41 lbs
963612DPS	36" x 96" x 12"	64 lbs



500-2,700 lb.
LOAD CAPACITY
For more detailed info
See pg. 133

Polymer Dunnage Rack

PERFORMANCE FEATURES:

- Available in 9 sizes
- Standard colors: Blue, Gray and Red
- Totes are injection molded from high-density polypropylene material that complies with the USDA and FDA regulations
- stack and nest totes will not corrode, bend out of shape, are unaffected by chemicals and are waterproof
- Reusable container will stack with or without lids for maximum storage and shipping
- snt's have the unique ability to stack or they can be turned 180° to nest when empty saving valuable space
- Optional lids for totes can be secured with nylon ties
- Textured bottoms ensure safe and easy, non-slip grip in transit on conveyors



LOWEST PRICE GUARANTEED!



Chrome Wire Shelving System with Genuine stack and nest totes

Offering a whopping 800 lb. capacity per shelf, this chrome wire shelving system with totes is a must have for archival storage, heavy-duty parts organization or inventory control applications. With three packages to choose from offering three colors choices for the bins, this system can be used just about anywhere. System may be made mobile with the addition of the **WR-00H** mobile kit. See **pg. 68** for additional information and to order optional accessories.

MODEL NO.	NO. OF SHELVES	NO. OF BINS	BIN DIMENSIONS L" x W" x H"	SHIP WGT
18" x 48" x 74" Wire Shelving Systems with stack and nest totes - Totes are available in Gray, Blue and Red				
WR9-36180	9	36 snt180	18" x 11" x 6"	178 lbs
WR6-24185	6	24 snt185	18" x 11" x 9"	136 lbs
24" x 66" x 63" Wire Shelving System with stack and nest totes - Totes are available in Gray, Blue and Red				
WR4-12225	4	12 snt225	23-1/2" x 19-1/2" x 10"	170 lbs

WR9-36180
Shown with optional lid and label holders (Sold separately)



MOBILIZE YOUR WIRE SHELVING

DB - Donut Bumper

Non-marking donut bumper used to protect walls and help cushion impact.

WR-00H (Mobile Kit)

Set of four swivel polyurethane 5" x 1-1/4" casters, two with brakes. Can be used with all units shown. 1,200 lb. load capacity.

Chrome Mobile Wire Shelving Systems with Cross Stack Tubs & Quantub Nesting Tote

These unique packages provide a storage solution for large, bulky items. These heavy-duty tubs provide easy access to stored parts for assembly areas, picking stations or inventory control. With three packages to choose from, these strong durable totes provide a durable solution for most applications. See **pg. 70** for more information.

MODEL NO.	NO. OF SHELVES	NO. OF BINS	BIN DIMENSIONS L" x W" x H"	SHIP WGT
24" x 60" x 69" Mobile, Wire Shelving System with QuanTub Totes - Totes are available in Gray and Blue				
MWR4-2419-9	4	12 TUB2419-9	24-1/2" x 19" x 9-1/2"	175 lbs
18" x 36" x 69" Mobile, Wire Shelving System with Cross Stack Tubs - Tubs are available in Gray, Blue and White				
MWR7-1711-8	7	24 TUB1711-8	17-1/4" x 11" x 8"	151 lbs
MWR5-1711-12	5	15 TUB1711-12	17-1/4" x 11" x 12"	118 lbs



MWR4-2419-9
These heavy-duty tubs provide easy access to stored parts for assembly areas



COMPLETE PACKAGES WITH BINS

WR7-92080
Allow for multiple compartment configurations within each bin

Chrome Wire Shelving System with Dividable Grid Containers

Same durable chrome wire shelving combined with Quantum's Dividable Grid Containers. These containers allow for multiple compartment configurations within each bin. Offering four different packages, these systems are ideal for small, medium and large parts storage. System may be made mobile with the addition of the **WR-00H** mobile kit. See **pg. 67** for additional container information and to order optional container accessories.

MODEL NO.	NO. OF SHELVES	NO. OF BINS	BIN DIMENSIONS L" x W" x H"	SHIP WGT
18" x 48" x 74" Wire Shelving Systems with Dividable Grid Containers - Containers are available in Gray, Blue, Red and Clear				
WR9-92060	9	36 DG92060	16-1/2" x 10-7/8" x 6"	210 lbs
WR7-92080	7	24 DG92080	16-1/2" x 10-7/8" x 8"	174 lbs
24" x 60" x 63" Wire Shelving System with Dividable Grid Containers - Containers are available in Gray, Blue, Red and Clear				
WR12-93030	12	36 DG93030	22-1/2" x 17-1/2" x 3"	274 lbs
24" x 60" x 74" Wire Shelving System with Dividable Grid Containers - Containers are available in Gray, Blue, Red and Clear				
WR9-93060	9	24 DG93060	22-1/2" x 17-1/2" x 6"	254 lbs

CLEAR VIEW
AVAILABLE on pg. 32

Cross Stack Tubs



5 SIZES AND 3 COLORS AVAILABLE

Manufactured from approved USDA/FDA materials, tote nests when empty or can be turned 90° to cross stack. Easy access to items when stacked. Injection molded from durable, high impact polypropylene. Easy to clean. Built in handle grips and bottom grooves makes handling easy. Holds up to 100 lb. 1/4" drill hole pattern on bottom of bin allows for easy hole insertion for optional air flow and drainage. Available in 3 colors. 6 per carton.

Available in: ●Blue ●Gray ○White

MODEL NO.	OUTSIDE DIMENSIONS L" x W" x H"	CAP GAL	CTN QTY	CTN WGT	LID	CTN QTY
TUB1711-8	17-1/4" x 11" x 8"	3.85	6	14 lbs	LID1711	6
TUB1711-12	17-1/4" x 11" x 12"	5.51	6	17 lbs	LID1711	6
TUB2417-8	23-3/4" x 17-1/4" x 8"	9.81	6	25 lbs	LID2417	6
TUB2417-12	23-3/4" x 17-1/4" x 12"	14.38	6	30 lbs	LID2417	6
TUB2516-8	25-1/8" x 16" x 8-1/2"	9.75	6	20 lbs	LID2516-8	6
SNH010	Six Clear Label Holders - 3" x 5"		6	1 lb	-	-

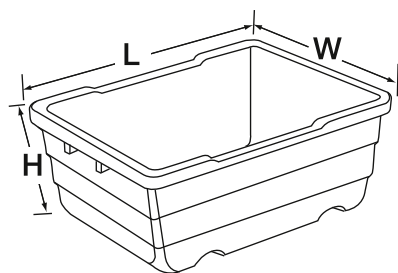

Bin Dimensions Guide
L (length) W (width) H (height)



LID2516-8
Optional lid keeps stored items dust free. Tubs can still stack or cross stack with lids in place.



QuanTub Nesting Tote



Manufactured of approved USDA/FDA materials, this tote is ideal in food service and storage and general product handling. Strong and durable tote is injection molded from high-density polypropylene. Each tote can hold up to 100 lb. Lightweight and economical tote is easy to clean. Rolled top rim for comfortable grip. Rounded corners add strength to stress points. Totes nest when empty and prevent jamming with rib top. 1/4" drill hole pattern on bottom of bin allows for easy hole insertion for optional air flow and drainage. Measures 24-1/2"L x 19"W x 9-1/2"H. Available in 2 colors. 6 per carton.

Available in: ●Blue ●Gray

MODEL NO.	OUTSIDE DIMENSIONS L" x W" x H"	CTN QTY	CTN WGT
TUB2419-9	24-1/2" x 19" x 9-1/2"	6	33 lbs



Polymer Mobile Dolly

DLY-3018 Dolly with Padded Rubber Trim available in Blue. 1,000 lb. capacity. Dimensions 30"L x 18"W

MODEL NO.	DESCRIPTION	CTN WGT
DLY-3018	Dolly with Padded Rubber Trim	19 lbs
HANDLE-DLY	32" Dolly Pull Rod with Handle	2 lbs



ATTACHED PULL RING allows dolly to be pulled with ease





Tub Racks - Complete Packages

All-welded aluminum Tub Rack transports and stores all types of product. Cart comes with four swivel 5" x 1" Polyolefin casters, 500 lb. load capacity. Runners allow bins to slide in and out from both sides. Rack comes complete with tubs. Tubs are available in 3 colors.

Available in: ● Blue ● Gray ○ White

MODEL NO.	DIMENSIONS L" x W" x H"	NO. OF BINS	SHIP WGT
Tub Rack with Cross Stack Tubs Tub Dimensions 25-1/8"L x 16"W x 8-1/2"H			
TR1-2516-8	27" x 19" x 19"	1	13 lbs
TR2-2516-8	27" x 19" x 31"	2	25 lbs
TR3-2516-8	27" x 19" x 41"	3	33 lbs
TR4-2516-8	27" x 19" x 51"	4	46 lbs
TR5-2516-8	27" x 19" x 61"	5	54 lbs
TR6-2516-8	27" x 19" x 71"	6	58 lbs



TR1-2516-8
Comes with 1 TUB2516-8

TR2-2516-8
Comes with 2 TUB2516-8

COMPLETE PACKAGES WITH BINS



TR3-2516-8
Comes with 3 TUB2516-8

TR4-2516-8
Comes with 4 TUB2516-8

TR5-2516-8
Comes with 5 TUB2516-8

TR6-2516-8
Comes with 6 TUB2516-8

Stackers - Heavy-duty Straight Wall Stacking Container

Heavy-duty, straight wall containers maximize your space when used for shipping, storage or work-in progress. Greater strength and durability provided by reinforced corners allowing this strong container to hold the heaviest of parts. Containers are injection molded from high-density polyethylene. Straight wall design allows for modular stacking of all sizes on standard pallets. Hand grips on two sides make the container easy to handle and carry. Up to 150 lb. stack capacity.

Available in: ● Gray

MODEL NO.	OUTSIDE DIMENSIONS L" x W" x H"	INSIDE DIMENSIONS L" x W" x H"	CTN QTY	VOLUME (CU FT)	SHIP WGT	LID
RSO1207-5	12" x 7-1/2" x 5"	9-3/4" x 5-1/2" x 5"	1	0.1	2 lbs	-
RSO1215-5	12" x 15" x 5"	9-1/2" x 13" x 5"	1	0.3	2 lbs	LID1215
RSO1215-7	12" x 15" x 7-1/2"	9-1/2" x 13" x 7"	1	0.5	3 lbs	LID1215
RSO1408-7	13-7/8" x 7-3/8" x 6-5/8"	11-3/16" x 5-5/8" x 5-3/4"	1	0.2	2 lbs	-
RSO2415-5	24" x 15" x 5"	21-1/2" x 13" x 5"	1	0.7	4 lbs	LID2415
RSO2415-7	24" x 15" x 7-1/2"	21-1/2" x 13" x 7"	1	1.1	5 lbs	LID2415
RSO2415-9	24" x 15" x 9-1/2"	21-1/2" x 13" x 9"	1	1.4	5 lbs	LID2415
RSO2422-11*	24" x 22-1/2" x 11"	21-1/2" x 20-1/2" x 10-1/4"	1	3.5	8 lbs	-

* Cannot be used on DLY-2415. Use with DLY-3018 Dolly.



RSO1408-7 available in Black only and with an attached lid.

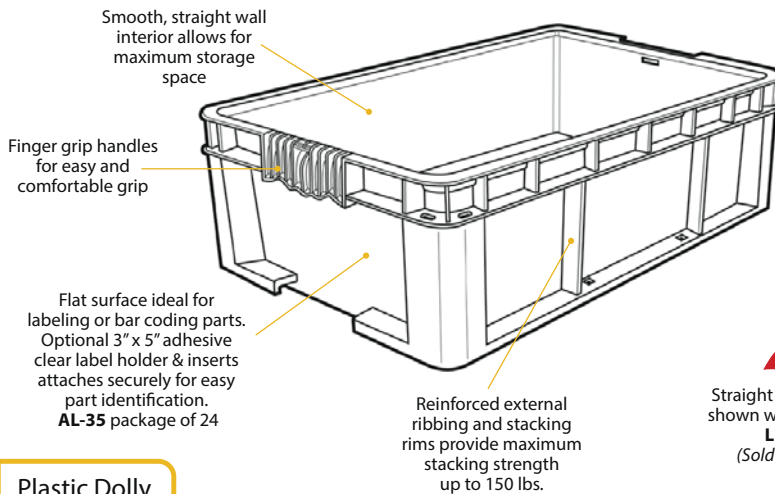

NEW

Straight Wall container shown with optional lid LID2415 (Sold Separately)



Plastic Dolly

DLY-2415 is 24"L x 15"W with 1" Ledge, available in Black. DLY-3018 is 30"L x 18"W with Padded Rubber Trim, available in Blue. Both dollies have 1,000 lb. load capacity.

MODEL NO.	DESCRIPTION	CTN WGT
DLY-2415	Dolly with 1" Ledge	14 lbs
DLY-3018	Dolly with Padded Rubber Trim	19 lbs

Bins sold separately.

MOBILIZE YOUR BINS

DLY-2415 Interior Dimensions 24"L x 15"W Exterior Dimensions 28"L x 18-1/2"W

SPACE SAVING, RETURNABLE, REUSABLE

Heavy-duty Collapsible Containers

Strong, reliable and reusable Collapsible Containers offer "true form" ergonomic carrying handles, designed for safer lifting. Containers have knock down ratios as high as 5:1, saving space and return freight. Modular to standard AIAG 48" x 45" pallet footprint. Large label and cardholder area provide easy identification and improved inventory control.

Available in: ● Gray

MODEL NO.	OUTSIDE DIMENSIONS L" x W" x H"	INSIDE DIMENSIONS L" x W" x H"	CTN QTY	SHIP WGT
RC1215-089	12" x 15" x 9"	10-1/2" x 13-3/8" x 8-1/2"	1	4 lbs
RC2415-075	24" x 15" x 7-1/2"	22-1/2" x 13-5/8" x 7"	1	5 lbs
RC2415-089	24" x 15" x 9"	22-1/4" x 13-3/4" x 8-1/2"	1	5 lbs
RC2415-111	24" x 15" x 11"	22-1/2" x 13-1/2" x 10-3/4"	1	6 lbs



Collapses down to 2-1/2"

Fully Expanded

RC1215-089

RC2415-075

RC2415-111

RC2415-089



LOWEST PRICE GUARANTEED!

9 SIZES AVAILABLE

STRONG, RELIABLE, REUSABLE TOTES



Polymer Mobile Dolly

DLY-2415 Dolly with 1" Ledge, available in Black. 1,000 lb. capacity. Interior Dimensions 24"L x 15"W Exterior Dimensions 28"L x 18-1/2"W

MODEL NO.	DESCRIPTION	CTN WGT
DLY-2415	Dolly with 1" Ledge	14 lbs

Bins sold separately.



QDL-2115

Distribution container has an optional 3" x 5" adhesive clear label holder and insert which attaches securely for easy part identification. Package of 24.

Heavy Duty Attached Top Containers - Perfect for distribution and supply centers



Strong, reliable and reusable totes are ideal for storage, distribution and order picking. Tops are permanently attached with hinges that interlock for stacking strength and security. Stack for maximized storage and nest when empty. Textured, non-slip bottom ensures smooth conveying. Ergonomically designed handles allow for easy lifting. Recensed lids ensure maximum load stability. Padlock eye provides security option allowing lids to be fastened and/or locked. Molded from high density, FDA approved polyethylene. Lids close securely to protect parts from dust or damage.



CUSTOM COLORS AVAILABLE
call for details

HOT STAMPING AVAILABLE
call for details

MODEL NO.	OUTSIDE DIMENSIONS		INSIDE DIMENSIONS		Available in: ● Gray ● Custom					
	TOP L" x W"	BOTTOM L" x W"	TOP L" x W"	BOTTOM L" x W"	CONTAINER HEIGHT	VOLUME (CU FT)	CAPACITY GAL	STACK CAP/ QTY STACKED	SHIP WGT	
QDC2012-7	19-5/8" x 11-9/16"	17" x 9-1/4"	17-9/16" x 9-13/16"	16-1/4" x 8-5/8"	7-1/2"	0.50	8.75	45 lbs / 7	4 lbs	
QDC2115-9	21-3/4" x 14-7/8"	18-15/16" x 13-1/8"	19-5/8" x 14"	18-3/8" x 12-9/16"	9-5/8"	1.27	9.50	65 lbs / 5	6 lbs	
QDC2115-12	21-3/4" x 15"	18-9/16" x 12-5/8"	19-3/4" x 14"	18" x 12-1/4"	12-3/4"	1.67	12.50	75 lbs / 5	7 lbs	
QDC2115-17	21-7/8" x 15-1/8"	18-3/8" x 12-7/8"	20" x 14-1/2"	17-7/8" x 12-1/2"	17-1/4"	2.31	17.25	100 lbs / 3	8 lbs	
QDC2213-12	22-1/8" x 12-5/8"	18-7/8" x 10-7/8"	19-7/8" x 12"	18-1/2" x 10-1/8"	11-7/8"	1.42	12.25	75 lbs / 5	6 lbs	
QDC2420-12*	23-7/8" x 19-3/8"	21-1/4" x 17-5/16"	22-1/4" x 18"	20-5/8" x 16-5/8"	12-1/2"	2.44	18.25	85 lbs / 5	8 lbs	
QDC2717-12	27-5/16" x 16-9/16"	24-1/4" x 14-1/2"	25-1/8" x 15-3/8"	23-3/8" x 13-3/4"	12-1/2"	2.50	18.75	100 lbs / 4	8 lbs	
QDC2515-14	25-3/8" x 16-1/4"	22-1/4" x 13-1/4"	23-1/8" x 14-1/4"	21-5/8" x 12-5/8"	14-1/8"	2.20	16.50	100 lbs / 4	8 lbs	
QDC2820-15*	28-1/8" x 20-5/8"	25-3/8" x 18-3/4"	25-7/8" x 19-3/4"	25-1/8" x 18"	15-5/8"	4.00	29.92	100 lbs / 4	13 lbs	

* Cannot be used on DLY-2415. Use with DLY-3018 Dolly.

Collapsible Bulk Box



Quantum's new collapsible bulk box provides a practical approach to large volume or large part material handling, storage and transport. Used for heavy loads, components and even food products, these reusable and returnable containers allow you to ship, handle, pick, store and distribute your products while increasing productivity and profitability. Quantum's collapsible bulk box comes in a standard pallet size footprint measuring 48"L x 45"W. It can be collapsed down to a fraction of its full height in seconds. Bulk containers stack perfectly loaded or when folded down to minimize storage space. They are designed to make the shipping of your products faster, safer and less costly while providing greater protection. Two access drop doors are able to lie flush against the container allowing easy loading and unloading. Manufactured from High Density Polyethylene, this tough container provides superior protection for products while being stored or in transit. Welded base provides greater strength while the reinforced fork openings provide easy lifting. Can withstand temperatures between -20° and 250°F. Available in Black.

HANDLE. SHIP. DISTRIBUTE. REUSE.



Fully expanded Bulk Box measures 48"L x 45"W x 34"H (Lid **LID-4845** Sold Separately)

NEW



Two access drop doors allows easy loading and unloading



Easy opening and collapsing of Bulk Box's side walls



Collapses to a fraction of it's full height



QBB-4845-34

PERFORMANCE FEATURES:

- Plastic, ergonomic latches for opening and collapsing
- Superior strength with low tare weight
- High return ratio: return 3 collapsed boxes for each bulk box distributed
- 1,800 lb. load capacity for standard usage
- Large, flat labeling area on all four sides

MODEL NO.	L (INCH/MM)	W (INCH/MM)	H (INCH/MM)
QBB-4845-34			
External	48.00/1219.2	45.00/1143.0	33.9/861.1
Internal	44.50/1130.3	41.50/1054.1	28.2/716.0
Usable interior height (fill line)	-	-	27.10/688.3
Access drop door - cut out	-	30.00/762.0	15.95/405.1
Collapsed height	-	-	12.76/324.0
Nested height	-	-	11.77/299.0
Stack of 9/collapsed (trailer)	-	-	106.93/2716.1
Fork tunnel - 48" side	-	11.00/279.4	3.40/86.4
Fork tunnel - 45" side	-	11.38/288.9	3.40/86.4
Ship wgt. - 118 lbs			



LOWEST PRICE GUARANTEED!

Mobile Frames

MODEL NO.	DIMENSIONS D" x W" x H"	SHIP WGT
Single Sided Mobile Frame		
TTS-18	18" x 38" x 67"	170
TTS-24	24" x 38" x 67"	174
Double Sided Mobile Frame		
TTD-30	30" x 38" x 67"	178
TTD-40	40" x 38" x 67"	184



TTS-24
Single Sided Mobile Frame



TTD-40
Double Sided Mobile Frame
Shown with (10) **TT-CT15**
(Sold separately)

Single and Double Sided Removable Tray Trucks



All welded construction with 1-1/2" square tubular frame. Slotted 12 gauge channel uprights (slots on 3-1/2" centers). Bolt on casters, 2 swivel and 2 rigid, for ease of replacement and superior cart tracking. Open and closed front trays and tray dividers sold separately.

Removable Trays

MODEL NO.	DIMENSIONS D" x W" x H"	SHIP WGT	TRAY DIVIDER MODEL NO.	QUANTITY OF TRAYS TO FIT MOBILE FRAMES			
				FRAME TTS-18	FRAME TTS-24	FRAME TTD-30	FRAME TTD-40
Open Front Trays							
TT-OT9	9" x 36" x 3"	16	TT-DIV3	14	14	28	28
TT-OT15	15" x 36" x 6"	28	TT-DIV6	-	7	-	14
Closed Front Trays							
TT-CT9	9" x 36" x 3"	16	TT-DIV3	14	14	28	28
TT-CT15	15" x 36" x 6"	28	TT-DIV6	-	7	-	14



TT-OT15
Open Tray



TT-CT15
Closed Tray

2,000 lb.
LOAD CAPACITY



Order this exact unit
TTD-OT15-240
Unit consists of:
1 - double sided frame **TTD-40**
10 - open front trays **TT-OT15**
40 - bins **QUS240**

MAGNUM Bin Transport Trucks



All welded construction with 1-1/2" x 3/16" thick angle frame construction. Twin 1-1/4" tubular handles with smooth radius bend. Bolt on urethane casters, 2 swivel & 2 rigid, for easy replacement and superior tracking. Bins are available in 5 colors.

Available in: ● Blue ● Green ● Red ● Yellow ● Black

MODEL NO.	DIMENSIONS D" x W" x H"	NO. OF BINS	BIN DIMENSIONS L" x W" x H"	SHIP WGT
5" x 1-1/4" Polyurethane Casters, 1,200 lb. Load Capacity				
MTT-1842-543	18" x 42" x 47"	6	19-3/4" x 18-3/8" x 11-7/8"	204 lbs
MTT-3042-743	30" x 42" x 47"	6	29" x 18-3/8" x 11-7/8"	238 lbs
5" x 2" Polyurethane Casters, 3,000 lb. Load Capacity				
MTT-1860-543	18" x 60" x 47"	9	19-3/4" x 18-3/8" x 11-7/8"	256 lbs
MTT-3060-743	30" x 60" x 47"	9	29" x 18-3/8" x 11-7/8"	290 lbs
MTT-1878-543	18" x 78" x 47"	12	19-3/4" x 18-3/8" x 11-7/8"	332 lbs
MTT-3078-743	30" x 78" x 47"	12	29" x 18-3/8" x 11-7/8"	380 lbs



MTT-3060-743
3,000 lb. capacity



MTT-1842-543
1,200 lb. capacity



MTT-1878-543
3,000 lb. capacity

Sloped Shelf Truck & Stand



All welded construction with 1-1/2" tubular center uprights with 3" x 3/16" thick horizontal construction. Stationary stand includes 5"H legs which allow unit to be moved with fork lift. Mobile cart includes bolt on 6" urethane casters, 2 swivel and 2 rigid. Bins are available in 7 colors.

Available in: ● Blue ● Green ● Ivory ● Red ● Yellow ● Black ● Clear

MODEL NO.	DIMENSIONS D" x W" x H"	NO. OF BINS	BIN DIMENSIONS L" x W" x H"	SHIP WGT
Stationary, 12 Sloped Shelf Stand				
SSB-S3036-230240	30" x 36" x 64"	60	10-7/8" x 5-1/2" x 5"	418 lbs
SSB-S3036	30" x 36" x 64"	-	14-3/4" x 8-1/4" x 7"	360 lbs
Mobile, 12 Sloped Shelf Cart				
MSSB-C3036-230240	30" x 36" x 66"	60	10-7/8" x 5-1/2" x 5"	453 lbs
MSSB-C3036	30" x 36" x 66"	-	14-3/4" x 8-1/4" x 7"	395 lbs



MSSB-C3036-230240
2,000 lb. capacity



SSB-S3036-230240
2,000 lb. capacity



LOWEST PRICE GUARANTEED!



PC4026-33
40" L x 26" W x 32-1/2" H



PFTC4026-33-3
40" L x 26" W x 32-1/2" H



PFTC4026-33-2
40" L x 26" W x 32-1/2" H

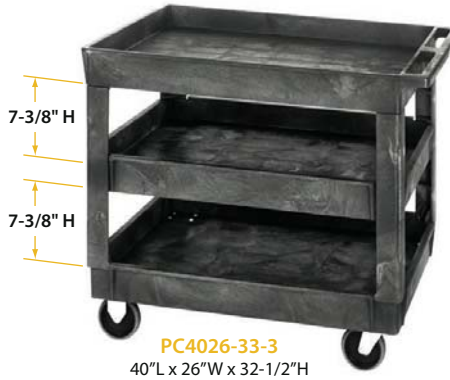

PC4026-33-3
40" L x 26" W x 32-1/2" H



PC3518-33-3
34-1/4" L x 17-1/2" W x 32-1/2" H

CARTS OFFER 550 lb. LOAD CAPACITY

Polymer Utility Carts

Industrial strength cart is ideal for many industrial and commercial material handling applications. Set of 2 swivel and 2 rigid 5" x 1-1/4" heavy-duty casters allow for 550 lb. load capacity. Available in two sizes with a 2 or 3 shelf combination.

Available in: ● Gray

MODEL NO.	OUTSIDE DIMENSIONS L" x W" x H"	INSIDE SHELF DIMENSIONS L" x W" x H"	NO. OF SHELVES	SHIP WGT
PC3518-33	34-1/4" x 17-1/2" x 32-1/2"	29-1/4" x 15-1/4" x 2-5/8"	2	38 lbs
PC3518-33-3	34-1/4" x 17-1/2" x 32-1/2"	29-1/4" x 15-1/4" x 2-5/8"	3	51 lbs
PC4026-33	40" x 26" x 32-1/2"	35" x 23" x 2-5/8"	2	54 lbs
PC4026-33-3	40" x 26" x 32-1/2"	35" x 23" x 2-5/8"	3	74 lbs
Polymer Flat Top Shelf Cart				
PFTC4026-33-2	40" x 26" x 32-1/2"	35" x 23"*	2	51 lbs
PFTC4026-33-3	40" x 26" x 32-1/2"	35" x 23"*	3	71 lbs
Additional Shelves				
PC3518SHELF	34-1/4" x 17-1/2" x 4-3/16"	29-1/4" x 15-1/4" x 2-5/8"	1	13 lbs
PC4026SHELF	40" x 26" x 4-3/16"	35" x 23" x 2-5/8"	1	20 lbs

* Inside dimension for middle and bottom shelf 35" x 23" x 2-5/8"

Shown with optional Tool Holder Attachment



PC3518-33 + PCTH
34-1/4" L x 17-1/2" W x 32-1/2" H
Shown with optional Tool Holder
(Tools not included)

Plastic Cart Tool Holder Attachment

MODEL NO.	DESCRIPTION	SHIP WGT
PCTH	96 Piece Tool Holder and Cart Attachment Patent Pending	3 lbs

RUGGED, HEAVY-DUTY, DURABLE

Tool Caddy



Deep compartments are ideal for automotive parts, hardware or cleaning supplies

TC-500



Industrial-strength polypropylene

Perfect for tools, parts and janitorial supplies.



Comfortable grip handle even when carrying heavy loads

Industrial strength, hand-held caddy ideal for tools and supplies. This portable, high density polypropylene caddy has extra strength ribs for support. Deep compartments make transporting tools, supplies and loose parts easy. 6 per carton.

Available in: ● Blue ● Gray

MODEL NO.	OUTSIDE DIMENSIONS L" x W" x H"	CTN QTY	CTN WGT
TC-500	13-7/8" x 18-3/8" x 9"	6	13 lbs

Environmentally Friendly Recycled Bins



Manufactured from recycled, 100% post consumer, high density polypropylene, these bins come in a complete range of sizes and have all the features of Quantum's standard bins at a more economical price. Available in Black only.



Recycled Ultra Hang & Stack Bins

See **pg. 5** for additional information on Ultra Hang & Stack Bins and to order window fronts, clear lids or dividers.

QGH700BR

QUS270BR

QUS250BR



QUS240BR

QUS230BR

QUS239BR

QUS255BR

QUS235BR

MODEL NO.	OUTSIDE DIMENSIONS L" x W" x H"	CTN QTY	CTN WGT
QUS200BR	5" x 4-1/8" x 3"	24	5 lbs
QUS210BR	5-3/8" x 4-1/8" x 3"	24	6 lbs
QUS220BR	7-3/8" x 4-1/8" x 3"	24	8 lbs
QUS221BR	9-1/4" x 6" x 5"	24	8 lbs
QUS224BR	10-7/8" x 4-1/8" x 4"	12	8 lbs
QUS230BR	10-7/8" x 5-1/2" x 5"	12	10 lbs
QUS234BR	14-3/4" x 5-1/2" x 5"	12	14 lbs
QUS235BR	10-7/8" x 11" x 5"	6	10 lbs
QUS239BR	10-3/4" x 8-1/4" x 7"	6	10 lbs
QUS240BR	14-3/4" x 8-1/4" x 7"	12	24 lbs
QUS241BR	13-5/8" x 8-1/4" x 6"	12	24 lbs
QUS242BR	13-5/8" x 8-1/4" x 8"	12	24 lbs
QUS245BR	10-7/8" x 16-1/2" x 5"	6	13 lbs
QUS250BR	14-3/4" x 16-1/2" x 7"	6	21 lbs
QUS255BR	16" x 11" x 8"	4	14 lbs
QUS260BR	18" x 11" x 10"	4	17 lbs
QUS265BR	18" x 8-1/4" x 9"	6	17 lbs
QUS270BR	18" x 16-1/2" x 11"	3	16 lbs
QUS275MOBBR	18" x 16-1/2" x 11"	6	19 lbs
QGH700BR	15-1/4" x 19-7/8" x 12-7/16"	3	13 lbs

Recycled Shelf Bins

See **pg. 50** for additional information on Shelf Bins and to order dividers and bin cups.

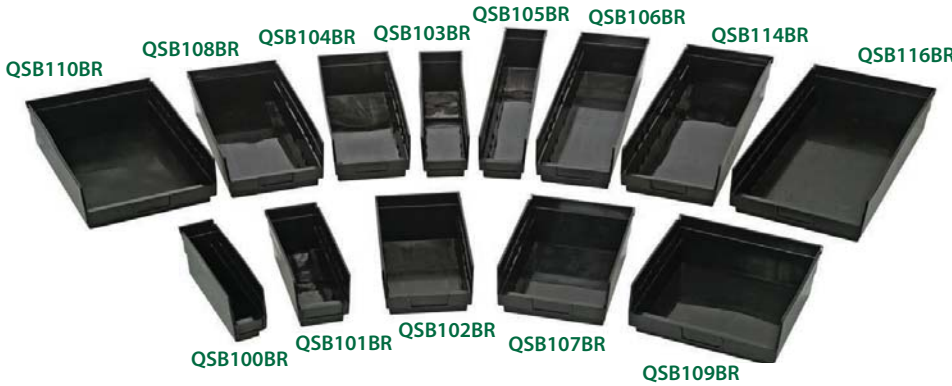

QSB110BR

QSB108BR

QSB104BR

QSB103BR

QSB105BR

QSB106BR

QSB114BR

QSB116BR

QSB100BR

QSB101BR

QSB102BR

QSB107BR

QSB109BR

MODEL NO.	OUTSIDE DIMENSIONS L" x W" x H"	CTN QTY	CTN WGT
QSB100BR	11-5/8" x 2-3/4" x 4"	36	13 lbs
QSB101BR	11-5/8" x 4-1/8" x 4"	36	17 lbs
QSB102BR	11-5/8" x 6-5/8" x 4"	30	18 lbs
QSB107BR	11-5/8" x 8-3/8" x 4"	20	15 lbs
QSB109BR	11-5/8" x 11-1/8" x 4"	8	7 lbs
QSB103BR	17-7/8" x 4-1/8" x 4"	20	13 lbs
QSB104BR	17-7/8" x 6-5/8" x 4"	20	16 lbs
QSB108BR	17-7/8" x 8-3/8" x 4"	10	11 lbs
QSB110BR	17-7/8" x 11-1/8" x 4"	8	11 lbs
QSB105BR	23-5/8" x 4-1/8" x 4"	16	13 lbs
QSB106BR	23-5/8" x 6-5/8" x 4"	8	9 lbs
QSB114BR	23-5/8" x 8-3/8" x 4"	6	9 lbs
QSB116BR	23-5/8" x 11-1/8" x 4"	6	10 lbs

Recycled MAGNUM Bins

See **pg. 47** for additional information on MAGNUM Bins and to order windows, dividers or a mobile option.



QMS531BR

QMS532BR

QMS533BR

QMS543BR

QMS743BR

MODEL NO.	OUTSIDE DIMENSIONS L" x W" x H"	CTN QTY	CTN WGT
QMS531BR	19-3/4" x 12-3/8" x 5-7/8"	6	19 lbs
QMS532BR	19-3/4" x 12-3/8" x 7-7/8"	6	23 lbs
QMS533BR	19-3/4" x 12-3/8" x 11-7/8"	3	15 lbs
QMS543BR	19-3/4" x 18-3/8" x 11-7/8"	1	8 lbs
QMS743BR	29" x 18-3/8" x 11-7/8"	1	10 lbs

MANUFACTURED FROM RECYCLED, 100% POST CONSUMER, HIGH DENSITY POLYPROPYLENE



LOWEST PRICE GUARANTEED!

Clear Compartment Storage Box

Utility box offers 10 compartments for small and medium parts storage. Manufactured of clear, see-through polypropylene.

MODEL NO.	OUTSIDE DIMENSIONS L" x W" x H"	CTN QTY	CTN WGT
QB900	10-1/4" x 13" x 2-3/8"	6	8 lbs



QB900

10 COMPARTMENTS FOR SMALL & MEDIUM PARTS

Wrench Holder

Versatile wrench holder can be mounted on a wall or can lay flat. Manufactured from high impact Polystyrene industrial-strength plastic and can hold up to 15 wrenches of different sizes. Mounting hardware is not included.

MODEL NO.	OUTSIDE DIMENSIONS L" x W" x H"	CTN QTY	CTN WGT
WH-15	1" x 7-1/8" x 11-5/8"	12	5 lbs



Tool Rack

Space saving tool rack is manufactured from durable polypropylene. Get organized with this tough rack that will not warp or bend even when it is loaded to capacity. Holds up to 96 items. Mounting hardware is not included.

MODEL NO.	OUTSIDE DIMENSIONS L" x W" x H"	CTN QTY	CTN WGT
TR-96	6" x 24-1/8" x 2-3/4"	12	9 lbs



Organizers

Clear lid design allows quick identification of parts inside. Unique latch design enables lid to close and latch tight and secure.

MODEL NO.	OUTSIDE DIMENSIONS L" x W" x H"	CTN QTY	CTN WGT
Single Sided			
ORG80032	13" x 10" x 2"	6	7 lbs
Double Sided			
ORG80322	13" x 10" x 3"	5	9 lbs



ORG80032 Single Sided Organizer

- Offers up to 22 storage compartments
- Includes 18 dividers allowing you to customize the size of the desired compartments inside



ORG80322 Double Sided Organizer

- Offers up to 32 storage compartments
- Includes 24 dividers allowing you to customize the size of the desired compartments inside

Portable Computer / LAN Work Center

New portable computer center and mini LAN (local area network) work center offers flexibility in any operation. The modular characteristics allow the unit to be adaptable to all your equipment requirements such as servers, PCs, printers, keyboards, and monitors. This system features adjustable shelves on 1" increments, quick field assembly without the use of tools, excellent strength, durable chrome finish and easy to roll locking 3" polyurethane casters.

- Unit consists of:
- 4 - 34" posts
 - 3 - 24" x 30" wire shelves
 - 1 - keyboard tray
 - 1 - document holder basket
 - 4 - 3" poly stem casters



M2430CLAN
(computer, monitor, keyboard, printer, folder not included)



Conductive Ultra Stack Bins and Dividers



Protect your electronic components from typical electromagnetic interference (EMI), electrostatic or induced fields with these conductive polypropylene bins. The conductive material provides a barrier which these fields cannot penetrate and prevents the build-up of electrostatic charge. Bins are permanently conductive and are unaffected by washing with normal cleaners. Molded from a carbon filled copolymer polypropylene material with an electrostatic decay rate at less than 0.1 second that meets conductivity standards as tested with ASTM-D257 methods. Its surface resistivity is less than 10⁵ Ohms-per square. Easy access to stored items with hopper front bin and label holder provides fast identification. Reinforced side walls and wide ledge allow high stacking on benches or shelving. Be sure all units are properly grounded according to your use. Color is Black.

MODEL NO.	OUTSIDE DIMENSIONS L" x W" x H"	CTN QTY	CTN WGT	DIVIDER	CTN QTY
QUS200CO	5" x 4-1/8" x 3"	24	5 lbs	DUS200CO	6
QUS210CO	5-3/8" x 4-1/8" x 3"	24	6 lbs	DUS210CO	6
QUS220CO	7-3/8" x 4-1/8" x 3"	24	8 lbs	DUS220CO	6
QUS230CO	10-7/8" x 5-1/2" x 5"	12	12 lbs	DUS230CO	6
QUS235CO	10-7/8" x 11" x 5"	6	10 lbs	DUS235CO	6
QUS239CO	10-3/4" x 8-1/4" x 7"	6	10 lbs	DUS239CO	6
QUS240CO	14-3/4" x 8-1/4" x 7"	12	24 lbs	DUS240CO	6
QUS250CO	14-3/4" x 16-1/2" x 7"	6	21 lbs	DUS250CO	6
QUS255CO	16" x 11" x 8"	4	14 lbs	DUS255CO	6
QUS260CO	18" x 11" x 10"	4	17 lbs	DUS260CO	6
QUS270CO	18" x 16-1/2" x 11"	3	16 lbs	DUS270CO	6

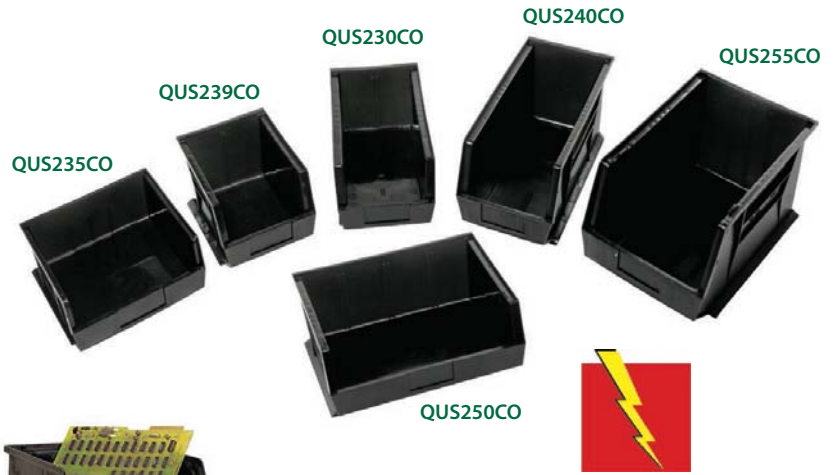

Conductive Stack & Lock Bins

Be sure all units are properly according to your use. Color is Black.

MODEL NO.	OUTSIDE DIMENSIONS L" x W" x H"	CTN QTY	CTN WGT
QCS10CO	4" x 3-7/8" x 2"	48	7 lbs
QCS20CO	7" x 3-7/8" x 2-7/8"	48	14 lbs
QCS30CO	10-1/4" x 5-7/8" x 5-1/8"	12	12 lbs
QCS40CO	13-1/2" x 8-1/8" x 6-1/8"	8	13 lbs

PROTECT YOUR ELECTRONIC COMPONENTS

LARGEST CONDUCTIVE SELECTION AVAILABLE ANYWHERE

CUSTOMIZE YOUR OWN UNIT

1. Select the hanging unit of your choice.
2. Use the chart above and choose the bin that best fits your need.
3. Go to the chart at the bottom of this page and determine how many bins fit on the unit you selected.
4. Place your order for both unit and bins.



QRU-16DCO + QRU-MOBSCO
Shown with 96 QUS230CO
(Bins sold separately)



QRU-16SCO
Shown with 48 QUS230CO
(Bins sold separately)



QRU-12DCO
Shown with 48 QUS240CO
(Bins sold separately)

Single Sided, Double Sided and Double Sided Mobile Rail Systems

Metal racks come complete with a grounding cable which when attached serves as a pathway for a static charge to travel to the ground. Ensure all racks are grounded properly and suited to your specific application.

MODEL NO.	DESCRIPTION	DIMENSIONS L" x W" x H"	QUANTITY OF ULTRA BINS TO FIT RAIL SYSTEMS										
			QUS 200CO	QUS 210CO	QUS 220CO	QUS 230CO	QUS 235CO	QUS 239CO	QUS 240CO	QUS 250CO	QUS 255CO	QUS 260CO	QUS 270CO
QRU-12SCO	Rack, 1 sided 12 rail	36" x 15" x 53"	96	96	96	-	-	24	24	12	12	8	
QRU-16SCO	Rack, 1 sided 16 rail	36" x 15" x 53"	-	-	-	48	24	-	-	-	-	-	
QRU-12DCO	Rack, 2 sided 12 rail	36" x 20" x 53"	192	192	192	-	-	48	48	24	24	16	
QRU-16DCO	Rack, 2 sided 16 rail	36" x 20" x 53"	-	-	-	96	48	-	-	-	-	-	
QRU-MOBSCO	Mobilizes Double Sided Systems												

See Conductive Ultra Stack Bins chart above for bin dimension



LOWEST PRICE GUARANTEED!

Conductive Louvered Panels

Accepts all sizes of Conductive Ultra Bins. Bins sold separately. See **pg. 80** for bin dimensions. Be sure all units are properly grounded according to your use. See chart below for additional sizes.

MODEL NO.	DIMENSIONS L" x H"	CTN QTY	SHIP WGT
QLP-1819CO	18" x 19" Louvered Panel	1	6 lbs
QLP-1861CO	18" x 61" Louvered Panel	1	21 lbs
QLP-2721CO	27" x 21" Louvered Panel	1	11 lbs
QLP-3612CO	36" x 12" Louvered Panel	1	8 lbs
QLP-3619CO	36" x 19" Louvered Panel	1	13 lbs
QLP-3661CO	36" x 61" Louvered Panel	1	40 lbs
QLP-4819CO	48" x 19" Louvered Panel	1	18 lbs
QLP-4861CO	48" x 61" Louvered Panel	1	60 lbs



QLP-1819CO
Shown with **16 QUS220CO**
(Bins sold separately)

LARGEST CONDUCTIVE SELECTION AVAILABLE ANYWHERE



Mobile Double Sided Louvered Racks

Mobile unit accepts all sizes of Ultra Bins (*up to 240 bins, 1,200 lb. capacity*). Bins sold separately. See **pg. 80** for bin dimensions. Be sure all units are properly grounded according to your use.

MODEL NO.	DIMENSIONS L" x W" x H"	CTN QTY	SHIP WGT
Single Sided System - 375 lb. capacity			
QSS-1866HCO	18"L x 12-1/2"W x 66"H	1	40 lbs
Single Sided System - 800 lb. capacity			
QSS-3666HCO	36"L x 12-1/2"W x 66"H	1	60 lbs
Double Sided System - 2,000 lb. capacity			
QDS-3666HCO	36"L x 25"W x 66"H	1	106 lbs
Double Sided, Mobile System - 1,200 lb. capacity			
QMD-36HCO	36"L x 25"W x 72"H	1	112 lbs



Conductive Bench Racks

Bench rack accepts all sizes of Ultra Bins. Bins sold separately. See chart below for additional sizes.

MODEL NO.	DIMENSIONS L" x W" x H"	CTN QTY	SHIP WGT
QBR-1819CO	18" x 8" x 19" Bench Rack	1	8 lbs
QBR-2721CO	27" x 8" x 21" Bench Rack	1	16 lbs
QBR-3612CO	36" x 8" x 12" Bench Rack	1	14 lbs
QBR-3619CO	36" x 8" x 19" Bench Rack	1	19 lbs



QBR-3619CO
Shown with **18 QUS230CO**
(Bins sold separately)

CUSTOMIZE YOUR OWN UNIT

1. Select the hanging unit of your choice.
2. Turn to **pg. 80** and choose the bin that best fits your need.
3. Go to the chart at the bottom of this page and determine how many bins fit on the unit you selected.
4. Place your order for both unit and bins.

QMD-36HCO
Shown with **72 QUS230CO**
and **24 QUS240CO**
(Bins sold separately)

QUANTITY OF ULTRA BINS TO FIT LOUVERED PANELS

MODEL NO.	QUS 200CO	QUS 210CO	QUS 220CO	QUS 230CO	QUS 235CO	QUS 239CO	QUS 240CO	QUS 250CO	QUS 255CO	QUS 260CO	QUS 270CO
QLP-1819CO	16	16	16	9	3	4	4	2	1	1	1
QLP-1861CO	60	60	60	30	15	14	14	7	7	5	5
QLP-2721CO	30	30	30	12	6	6	6	2	4	4	1
QLP-3612CO	18	18	18	12	6	4	4	2	6	3	2
QLP-3619CO	40	40	40	18	9	8	8	4	6	3	2
QLP-3661CO	120	120	120	60	30	28	28	14	21	15	10
QLP-4819CO	55	55	55	24	12	10	10	4	8	8	2
QLP-4861CO	165	165	165	80	40	35	35	14	28	20	10
QBR-1819CO	16	16	9	9	3	4	4	2	1	1	1
QBR-2721CO	30	30	12	12	6	6	6	2	4	4	1
QBR-3612CO	18	18	12	12	6	4	4	2	6	3	2
QBR-3619CO	32	32	18	18	9	8	8	4	6	3	2
QSS-1866HCO	60	60	60	30	15	14	14	7	7	5	5
QSS-3666HCO	12	12	12	60	30	28	28	14	21	15	10
QDS-3666HCO	240	240	240	120	60	56	56	28	42	30	20
QMD-36HCO	240	240	240	120	60	56	56	28	42	30	20

See pg. 80 for bin dimensions.



Conductive Shelf Bins



Protect your electronic components from typical electromagnetic interference (EMI), electrostatic or induced fields with these molded, carbon-filled, copolymer polypropylene bins. Surface resistivity is less than 10⁵ Ohms-per square. Easy access to stored items with hopper front bin and label holder provides fast identification. The conductive material provides a barrier which these fields cannot penetrate and prevents the build-up of electrostatic charge. Bins are permanently conductive and are unaffected by washing with normal cleaners. Be sure all units are properly grounded according to your application.

Available in: ● Black

MODEL NO.	OUTSIDE DIMENSIONS L" x W" x H"	CTN QTY	CTN WGT	DIVIDER	CTN QTY
QSB100CO	11-5/8" x 2-3/4" x 4"	36	13 lbs	-	-
QSB101CO	11-5/8" x 4-1/8" x 4"	36	17 lbs	DSB101CO	50
QSB102CO	11-5/8" x 6-5/8" x 4"	30	18 lbs	DSB102CO	50
QSB107CO	11-5/8" x 8-3/8" x 4"	20	15 lbs	DSB107CO	50
QSB109CO	11-5/8" x 11-1/8" x 4"	8	7 lbs	DSB109CO	50
QSB103CO	17-7/8" x 4-1/8" x 4"	20	13 lbs	DSB103CO	50
QSB104CO	17-7/8" x 6-5/8" x 4"	20	16 lbs	DSB104CO	50
QSB108CO	17-7/8" x 8-3/8" x 4"	10	11 lbs	DSB108CO	50
QSB110CO	17-7/8" x 11-1/8" x 4"	8	11 lbs	DSB110CO	50
QSB105CO	23-5/8" x 4-1/8" x 4"	16	13 lbs	DSB105CO	50
QSB106CO	23-5/8" x 6-5/8" x 4"	8	9 lbs	DSB106CO	50
QSB114CO	23-5/8" x 8-3/8" x 4"	6	9 lbs	DSB114CO	50
QSB116CO	23-5/8" x 11-1/8" x 4"	6	10 lbs	DSB116CO	50

13 SIZES AVAILABLE



QSB101CO



QSB103CO



QSB106CO



QSB107CO

12", 18" & 24" DEPTHS

Conductive Complete Bin Center

Complete bin systems are available with 4 different size bins on a 12"W x 36"L x 36"H unit. This all-purpose bin center is an economical high density storage system that provides easy visibility to stored contents.

MODEL NO.	NO. OF BINS	BIN SIZE L" x W" x H"	SHIP WGT
12" x 36" x 36" 6 Shelf Systems			
WR6-36-1236-101CO	40 QSB101CO	11-5/8" x 4-1/8" x 4"	63 lbs
WR6-36-1236-102CO	25 QSB102CO	11-5/8" x 6-5/8" x 4"	50 lbs
WR6-36-1236-107CO	20 QSB107CO	11-5/8" x 8-3/8" x 4"	62 lbs
WR6-36-1236-109CO	15 QSB109CO	11-5/8" x 11-1/8" x 4"	64 lbs

Conductive Shelf Bin Wire Shelving Systems Complete Packages

MODEL NO.	NO. OF BINS	BIN SIZE L" x W" x H"	SHIP WGT
12" x 36" x 74" 12 Shelf Systems			
WR12-101CO	88 QSB101CO	11-5/8" x 4-1/8" x 4"	120 lbs
WR12-102CO	55 QSB102CO	11-5/8" x 6-5/8" x 4"	116 lbs
WR12-107CO	44 QSB107CO	11-5/8" x 8-3/8" x 4"	117 lbs
WR12-109CO	33 QSB109CO	11-5/8" x 11-1/8" x 4"	119 lbs
18" x 36" x 74" 12 Shelf Systems			
WR12-103CO	88 QSB103CO	17-7/8" x 4-1/8" x 4"	176 lbs
WR12-104CO	55 QSB104CO	17-7/8" x 6-5/8" x 4"	165 lbs
WR12-108CO	44 QSB108CO	17-7/8" x 8-3/8" x 4"	170 lbs
WR12-110CO	33 QSB110CO	17-7/8" x 11-1/8" x 4"	168 lbs
24" x 36" x 74" 12 Shelf Systems			
WR12-105CO	88 QSB105CO	23-5/8" x 4-1/8" x 4"	228 lbs
WR12-106CO	55 QSB106CO	23-5/8" x 6-5/8" x 4"	218 lbs
WR12-114CO	44 QSB114CO	23-5/8" x 8-3/8" x 4"	222 lbs
WR12-116CO	33 QSB116CO	23-5/8" x 11-1/8" x 4"	206 lbs

CONVERT STANDARD WIRE SHELVING INTO CONDUCTIVE SHELVING WITH THESE ACCESSORIES THAT ARE INCLUDED WITH THESE PACKAGES



ESD-DC Drag Chain



WR-SSCO Plastic Conductive Split Sleeve



800 lb. CAPACITY PER SHELF

MOBILIZE YOUR WIRE SHELVING

DB - Donut Bumper
Non-marking donut bumper used to protect walls and help cushion impact.

WR-00CO (Mobile Kit)*
Set of four swivel ESD/Conductive 5" x 1-1/4" casters, two with brakes. Can be used with all units shown. 1,200 lb. load capacity. *Mobile kits recommended only for shelves 18" and wider.



WR6-36-1236-102CO

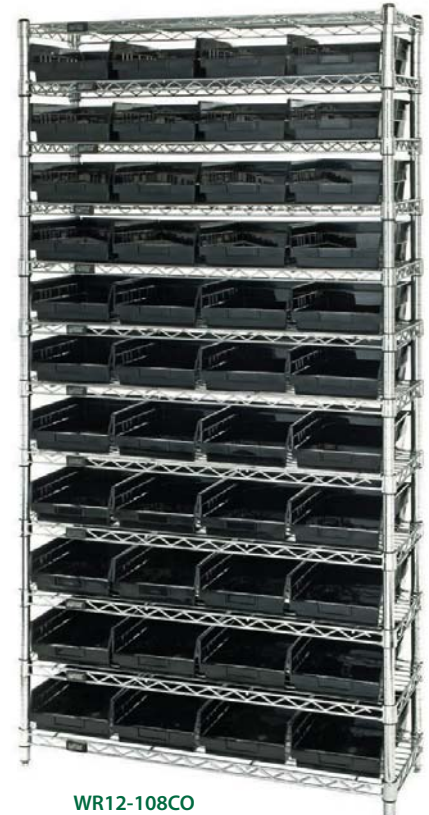

WR12-108CO



LOWEST PRICE GUARANTEED!

9 SIZES AVAILABLE



Conductive Dividable Grid Containers



Protect your electronic components from typical electromagnetic interference (EMI), electrostatic or induced fields with these molded, carbon-filled, copolymer polypropylene dividable grid containers. Surface resistivity is less than 10^5 Ohms-per square. The conductive material provides a barrier which these fields cannot penetrate and prevents the build-up of electrostatic charge. Containers, dividers and covers are permanently conductive and are unaffected by washing with normal cleaners. Containers have a load capacity of 100 lb. Dividers available to customize your box into compartments at 1-1/8" intervals and snap covers protect contents from dust or damage. Be sure all units are properly grounded according to your use. Color is Black.

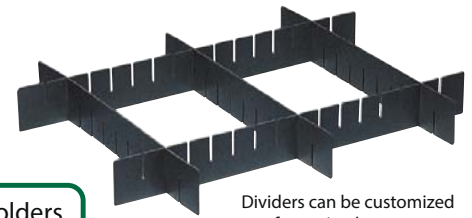

Label Holders

Dividers can be customized for optimal storage (Sold separately)

MODEL NO.	DIMENSIONS H" x W"	FITS BIN MODEL NO.	CTN QTY
LBL2X8CO	2" x 8"	DG91035CO, DG92035CO, DG93030CO	6
LBL3X5CO	3" x 5"	DG91050CO, DG92060CO, DG93060CO	6
LBL5X8CO	5" x 8"	DG92080CO, DG93080CO, DG93120CO	6

Available in: ● Black

MODEL NO.	OUTSIDE DIMENSIONS L" x W" x H"	INSIDE DIMENSIONS L" x W" x H"	CTN QTY	CTN WGT	LONG DIVIDER	CTN QTY	SHORT DIVIDER	CTN QTY	COVER	CTN QTY
DG91035CO	10-7/8" x 8-1/4" x 3-1/2"	9-3/16" x 6-9/16" x 3"	20	24 lbs	DL91035CO	6	DS91035CO	6	COV91000CO	10
DG91050CO	10-7/8" x 8-1/4" x 5"	9-3/16" x 6-9/16" x 4-1/2"	20	32 lbs	DL91050CO	6	DS91050CO	6	COV91000CO	10
DG92035CO	16-1/2" x 10-7/8" x 3-1/2"	14-7/8" x 9-1/4" x 3"	12	23 lbs	DL92035CO	6	DS92035CO	6	COV92000CO	4
DG92060CO	16-1/2" x 10-7/8" x 6"	14-7/8" x 9-1/4" x 5-1/2"	8	20 lbs	DL92060CO	6	DS92060CO	6	COV92000CO	4
DG92080CO	16-1/2" x 10-7/8" x 8"	14-7/8" x 9-1/4" x 7-1/2"	8	27 lbs	DL92080CO	6	DS92080CO	6	COV92000CO	4
DG93030CO	22-1/2" x 17-1/2" x 3"	20-5/8" x 15-5/8" x 2-1/2"	6	20 lbs	DL93030CO	6	DS93030CO	6	COV93000CO	3
DG93060CO	22-1/2" x 17-1/2" x 6"	20-5/8" x 15-5/8" x 5-1/2"	3	19 lbs	DL93060CO	6	DS93060CO	6	COV93000CO	3
DG93080CO	22-1/2" x 17-1/2" x 8"	20-5/8" x 15-5/8" x 7-1/2"	3	16 lbs	DL93080CO	6	DS93080CO	6	COV93000CO	3
DG93120CO	22-1/2" x 17-1/2" x 12"	20-5/8" x 15-5/8" x 11-1/2"	3	23 lbs	DL93120CO	6	DS93120CO	6	COV93000CO	3



Dividers

Containers can be divided by length and/or width allowing a subdivision down to a 1-1/8" square compartment size. Available in Black.



Snap On Covers

Snap on covers protect contents from damage or dust during shipping and storage.



Label Holders

Fits any size container. Three sizes to choose from.



BC212434M1CO

COMPLETE PACKAGES WITH BINS

Conductive Bin Carts

Offering two heights and four bin quantity designs, these modular carts are the ultimate work-in-process and transport cart. Dividable grids slide easily in and out and with their ability to be divided into multiple compartments with long and short dividers, truly any type of storage is possible. Dividable grids are available in Black. **Cart Finish:** Chrome

MODEL NO.	NO. OF BINS	BIN DIMENSIONS L" x W" x H"	SHIP WGT
21"W x 24"L x 45"H Bin Cart with Dividable Grid Containers			
BC212434M1CO	4 DG93060CO	22-1/2" x 17-1/2" x 6"	58 lbs
BC212439M2CO	7 DG93030CO	22-1/2" x 17-1/2" x 3"	79 lbs
21"W x 24"L x 69"H Bin Cart with Dividable Grid Containers			
BC212469M1CO	7 DG93060CO	22-1/2" x 17-1/2" x 6"	107 lbs
BC212469M2CO	11 DG93030CO	22-1/2" x 17-1/2" x 3"	111 lbs
21"W x 24"L x 45"H Bin Cart with No Dividable Grid Containers			
BC212439M4CO	No containers (includes slides for 4 bin levels)		46 lbs
BC212439M7CO	No containers (includes slides for 7 bin levels)		55 lbs
21"W x 24"L x 69"H Bin Cart with No Dividable Grid Containers			
BC212469MCO	No containers (includes slides for 7 bin levels)		63 lbs
BC212469M1CO	No containers (includes slides for 11 bin levels)		75 lbs



Conductive Wire Utility Carts

Carts consists of 2 u-handles, 4 donut bumpers, 4 conductive swivel casters (2 with brakes), drag chain and 2 or 3 wire shelves.

MODEL NO.	DIMENSIONS W" x L" x H"	SHIP WGT
2 Wire Shelf Mobile Utility Carts		
WRC-1836-2CO	18" x 36" x 37-1/2"	30 lbs
WRC-1842-2CO	18" x 42" x 37-1/2"	32 lbs
WRC-1848-2CO	18" x 48" x 37-1/2"	37 lbs
WRC-2436-2CO	24" x 36" x 37-1/2"	36 lbs
WRC-2442-2CO	24" x 42" x 37-1/2"	40 lbs
WRC-2448-2CO	24" x 48" x 37-1/2"	44 lbs
3 Wire Shelf Mobile Utility Carts		
WRC-1836-3CO	18" x 36" x 37-1/2"	37 lbs
WRC-1842-3CO	18" x 42" x 37-1/2"	42 lbs
WRC-1848-3CO	18" x 48" x 37-1/2"	48 lbs
WRC-2436-3CO	24" x 36" x 37-1/2"	49 lbs
WRC-2442-3CO	24" x 42" x 37-1/2"	55 lbs
WRC-2448-3CO	24" x 48" x 37-1/2"	60 lbs



WRC-1836-2CO

ESD Modular Trays



18" x 26" and 20" x 26" trays are ESD and comply with ANSI / ESD standards for the use in PC board assembly and handling. All trays are manufactured of fiberglass reinforced thermoset material, allowing up to 200 lb. weight capacity when evenly distributed. Quantum's modular trays will withstand temperatures of -40°F to +350°F. Trays are resistant to abrasion and chemicals. Trays are permanently conductive, properties are unaffected by washing in steam or water. Trays available in ESD Black.

Available in: ● Black

MODEL NO.	DIMENSIONS W" x L" x H"	SHIP WGT
1826ESD	18" x 26" x 1-1/8"	4 lbs
2026ESD	20" x 26" x 1-1/2"	5 lbs



200 lb.
CAPACITY PER TRAY

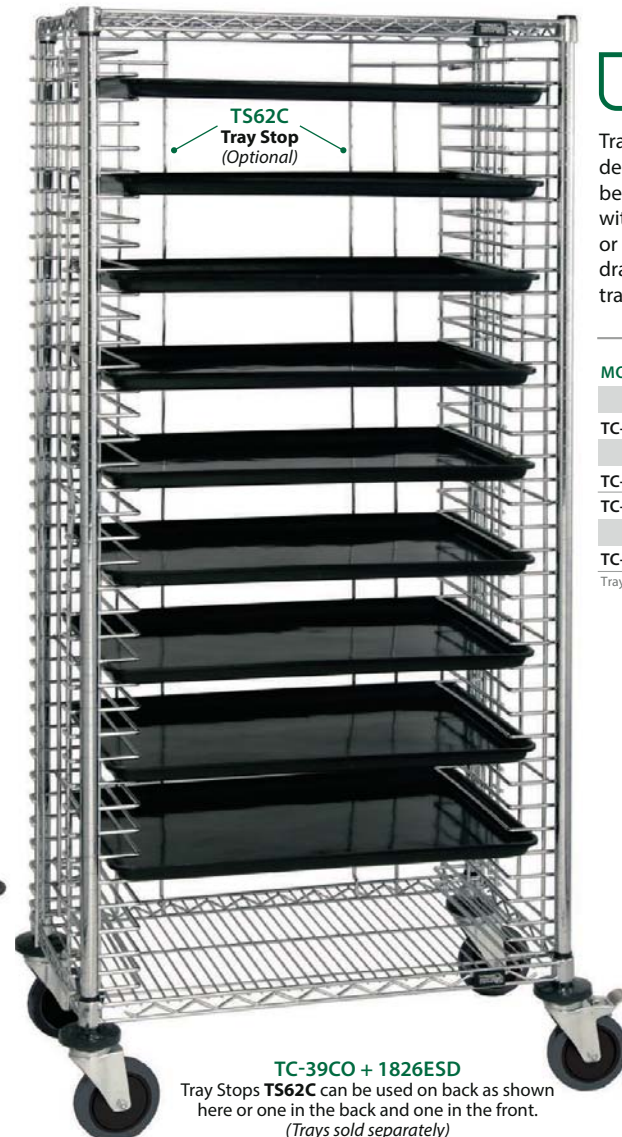

TC-39CO + 1826ESD

Tray Stops **TS62C** can be used on back as shown here or one in the back and one in the front. (Trays sold separately)

Conductive Modular Tray Carts

Tray carts are offered in half size and full size units, designed to handle work in process. ESD trays can be used on tray cart for conductive applications with the addition of aluminum split sleeves (*ESD-SS*) or conductive plastic split sleeves (*WR-SSCO*) and a drag chain (*ESD-DC*). Optional Tray Stop prevents trays from falling out. **Cart finish:** Chrome

MODEL NO.	DIMENSIONS W" x L" x H"	CAPACITY	SHIP WGT	TRAY STOP MODEL NO.
39"H Side Load Tray Cart				
TC-19CO	18" x 30" x 39"	19 Trays	45 lbs	TS32C
69"H Side Load Tray Carts				
TC-39CO	18" x 30" x 69"	39 Trays	74 lbs	TS62C
TC-31CO	21" x 30" x 69"	31 Trays	68 lbs	TS62C
69"H End Load Tray Carts				
TC-EL38CO	21-3/4" x 27" x 69"	38 Trays	74 lbs	TS62C

Trays are sold separately.

CONVERT STANDARD WIRE SHELVING INTO CONDUCTIVE SHELVING WITH THESE ACCESSORIES THAT ARE INCLUDED WITH THESE PACKAGES



ESD-DC Drag Chain



WR-SSCO Plastic Conductive Split Sleeve

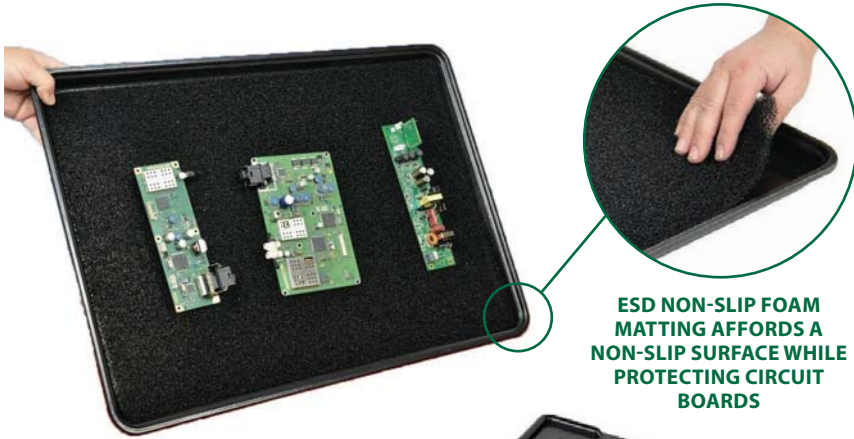

ESD NON-SLIP FOAM MATTING AFFORDS A NON-SLIP SURFACE WHILE PROTECTING CIRCUIT BOARDS

INTERIOR FOAM PACKAGING ENSURING SAFE AND SECURE STORAGE AND TRANSPORT



ESD STATIC SAFE STORAGE FOR ALL FOUR SIDED CONTAINERS



CUSTOM DIVIDERS TO MAXIMIZE STORAGE AND PROTECT YOUR SPECIFIC PARTS



Custom Protection & Internal Dunnage

Quantum's custom dunnage protects your valuable items, parts, and products from damage during transport, work in process, and storage. Quantum can offer you a custom solution to offer any level of protection required in your specific application. Call for more information.

BENEFITS:

- Cushion and vibration support and protection
- ESD/Conductive protection
- Part and product protection
- Reduced packaging costs with safer transportation

OPTIONS INCLUDE:

- Thermoformed inserts
- Fluted plastic dividers
- Multi-layers of foam trays
- Non-skid foam
- Adjustable dividers

CUSTOM SOLUTIONS OFFER ANY LEVEL OF PROTECTION REQUIRED

CUSTOM PARTITIONING FOCUSED ON SEPARATION AND PROTECTION



Clear Tip Out Bins



THE ORIGINAL & INDUSTRY STANDARD

Space saving bin units keep small and medium sized parts organized, sorted and easy to find. These clear, break resistant injection molded plastic containers tip open smoothly to a 45° angle and are completely removable for easy access and refilling. Molded handle with slots for labels is provided. Bins are easily cleaned with soap and water. Polystyrene cabinet can be stacked or wall mounted. Exterior available in 3 colors. Cups are clear. Optional dividers, locking rod and louvered panel bracket also available.

Available in: ● Ivory ● Gray ○ White

MODEL NO.	OUTSIDE DIMENSIONS L" x W" x H"	BIN DIMENSIONS L" x W" x H"	CTN QTY	CTN WGT
QTB301	11-3/4" x 11-13/16" x 13-7/8"	8-7/8" x 11-1/16" x 13-5/8"	1	7 lbs
QTB302	11-3/4" x 23-5/8" x 13-7/8"	8-7/8" x 11-1/16" x 13-5/8"	1	14 lbs
QTB303	7-3/4" x 23-5/8" x 9-1/2"	5-7/8" x 7-3/8" x 8-5/8"	1	9 lbs
QTB304	6-5/8" x 23-5/8" x 8-1/8"	5" x 5-5/8" x 7-1/2"	1	7 lbs
QTB305	5-1/4" x 23-5/8" x 6-1/2"	3-3/4" x 4-1/4" x 5-3/4"	1	5 lbs
QTB306	3-5/8" x 23-5/8" x 4-1/2"	2-5/8" x 3-1/2" x 3-3/4"	1	2 lbs
QTB309	2-1/2" x 23-5/8" x 3-1/8"	1-3/4" x 2-3/16" x 2-1/2"	1	2 lbs
DIV303	3 Dividers for QTB303		3	2 lbs
DIV304	4 Dividers for QTB304		4	1 lb
QLR500	Locking Rod for 23-5/8"W Tip Out Bins		1	1 lb
QTB-LP-BKT	Louvered Panel Bracket pair for Tip Out Bins (Sold as a pair)		2	1 lb

TIP OUT BIN CLEAR COMPARTMENTS KEEP SMALL ITEMS SORTED AND EASY TO FIND



QTB-LP-BKT
Louvered Panel Bracket
Hang 23-5/8"W bin on louvered panel using bracket. Available in Beige or Gray. Panels available on pg. 8.



QLR500
Locking Rod
Keeps bins from tilting open. Can be used with 23-5/8"W bins.



DIV303 and DIV304
QTB303 and QTB304 cup can use optional divider, as shown above.



QTB309



QTB306



QTB305



QTB304



QTB303



QTB302



QTB301

TIP OUT BIN



LOWEST PRICE GUARANTEED!

CLEAR TIP OUT BIN SYSTEMS CAN BE USED IN ANY APPLICATION



INDUSTRIAL, MECHANICAL AND PLUMBING SUPPLIES

Very handy for the garage, tool shed, service vehicle, factory, hardware and home center facilities.



MEDICAL

Very efficient when it comes to organizing and keeping an effective inventory in hospitals, pharmacies, labs or clinics.



PLAYROOM

The smartest organizer after a hard day's play. It will help keep your child's room in order.



QT B410

QT B410 is a one bin design, 12" wide
Each **QT B410** comes with **3 DIV400** clear dividers*



QT B411

QT B411 is a two bin design, each bin 12" wide
Each **QT B411** comes with **6 DIV400** clear dividers*



QT B412

QT B412 is a one bin design, 23-5/8" wide
Each **QT B412** comes with **5 DIV400** clear dividers*
*Note: Dividers shown in white color for clarity.

TIP OUT BIN

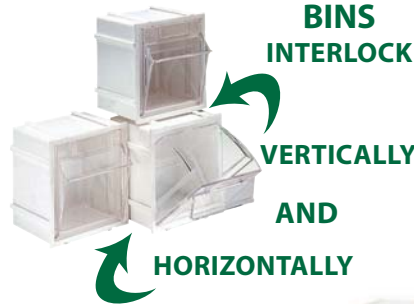

BINS INTERLOCK

VERTICALLY

AND

HORIZONTALLY



QT B409

QT B406

QT B405

Dividable Tip Out Bins



These bins feature removable and adjustable dividers so that the clear bin can be partitioned into smaller compartments. Ideal for larger or longer items, these clear Tip Out Bins are molded from the same strong and flexible material as our standard bins. The flexibility of bins allow the user to determine the size and volume of each storage compartment. Exterior available in 3 colors. Cups are clear.

Available in: ● Ivory ● Gray ○ White

MODEL NO.	OUTSIDE DIMENSIONS L" x W" x H"	CTN QTY	CTN WGT
QT B410	5-1/4" x 11-7/8" x 5-15/16"	1	3 lbs
QT B411	5-1/4" x 23-5/8" x 5-15/16"	1	4 lbs
QT B412	5-1/4" x 23-5/8" x 5-15/16"	1	4 lbs
DIV400	Divider For Dividable Tip Out Bins	4	1 lbs

PERFORMANCE FEATURES:

- Dividable Tip Out Bins are available in 3 sizes (2 with the same width)
- Bins can be stacked as modular units or used individually
- Exterior housing is injection molded from high impact Polystyrene
- Clear bin cups are injection molded from a custom blend of Phillips K Resin and Crystal Styrene for clarity and durability
- Compartments tip open smoothly to a 45° angle and provide comfortable and complete access to stored items
- The flexibility of the system allows you to customize your own system to meet your specific needs



TBC-32WT
Tip Out Bin Cart

19-1/2"L x 25"W x 41"H

Comes complete with one 5-bin, two 4-bin units and one 3-bin unit on each side. Comes fully assembled, ready to use. Available in White.

Individual Tip Out Bins



These unique bins have the ability to interlock horizontally or vertically. Available in three popular sizes, these bins allow you to create your own customized Tip Out Bin storage system perfect for color coding.

QT B405 & QT B406 available in: ● Ivory ● Gray ○ White
QT B409 available in: ● Blue ● Red ● Yellow ○ White

MODEL NO.	OUTSIDE DIMENSIONS L" x W" x H"	CTN QTY	CTN WGT
QT B405	5-1/4" x 4-3/4" x 6-1/4"	5	6 lbs
QT B406	3-5/8" x 4-1/16" x 4-1/4"	6	4 lbs
QT B409	2-3/8" x 2-13/16" x 3"	9	3 lbs

Clear Tip Out Bin Floor Stands - Single, Double and Mobile
Clearly your best storage solution

Nine pre-configured systems available as pictured allowing you to purchase your Tip Out system exactly as shown here. The flexibility of the system also allows you to customize and create your own configurations (*see chart for all possibilities*). All steel systems are formed from heavy-duty 14 gauge steel and have a powder coat finish ensuring years of use. Three different heights to choose from: 24", 48" or 70". Systems are single sided, double sided or double sided mobile. Tip Out Bins are available in 3 exterior colors. See **pg. 86** for bin dimensions.

**SINGLE SIDED
 300 lb.
 LOAD CAPACITY**

QFS124-31
 1 QTB304
 3 QTB306
 1 QTB309



QFS148-38
 1 QTB302
 1 QTB303
 1 QTB304
 1 QTB305
 1 QTB306
 2 QTB309



QFS170-36
 4 QTB303
 2 QTB304
 2 QTB305
 1 QTB306



**TIP OUT
 BIN**

**COMPLETE PACKAGES
 WITH BINS**

**DOUBLE SIDED
 600 lb.
 LOAD CAPACITY**

QFS224-24
 2 QTB303
 2 QTB304
 2 QTB305



QFS248-76
 2 QTB302
 2 QTB303
 2 QTB304
 2 QTB305
 2 QTB306
 4 QTB309



QFS270-72
 8 QTB303
 4 QTB304
 4 QTB305
 2 QTB306





LOWEST PRICE GUARANTEED!

CREATE YOUR OWN CUSTOM CONFIGURATION



wall frames single sided double sided double sided mobile

Mobile Clear Tip Out Bin Floor Stands

COMPLETE PACKAGES WITH BINS

QFS224-24 + QFS400
2 QTB303
2 QTB304
2 QTB305



TIP OUT
TIP OUT
TIP OUT
BIN

QFS270-72 + QFS400
8 QTB303
4 QTB304
4 QTB305
2 QTB306



QFS248-76 + QFS400
2 QTB302
2 QTB303
2 QTB304
2 QTB305
2 QTB306
4 QTB309

MOBILE 500 lb. LOAD CAPACITY

Available in: ● Ivory ● Gray ○ White

MODEL NO.	DESCRIPTION	DIMENSIONS D" x W" x H"	CTN WGT	QTY. OF BINS TO FIT SYSTEM								
				QTB 302	QTB 303	QTB 304	QTB 305	QTB 306	QTB 309			
Floor Stands - Single Sided (Disks and Screws Required)												
QFS124	24"H Single Sided (Workstation)	8" x 23-5/8" x 28"	11 lbs	1	2	3	3	5	8			
QFS148	48"H Single Sided	8" x 23-5/8" x 52"	19 lbs	3	5	6	7	11	16			
QFS170	70"H Single Sided	8" x 23-5/8" x 75"	20 lbs	5	7	8	10	15	23			
Floor Stands - Double Sided (Disks and Screws Required)												
QFS224	24"H Double Sided (Workstation)	16" x 23-5/8" x 28"	21 lbs	2	4	6	6	10	16			
QFS248	48"H Double Sided	16" x 23-5/8" x 52"	36 lbs	6	10	12	14	22	32			
QFS270	70"H Double Sided	16" x 23-5/8" x 75"	42 lbs	10	14	16	20	30	46			
Mobile Kit (Includes four casters and one handle)												
QFS400	Mobile Kit for Double Sided Systems		9 lbs	-	-	-	-	-	-			
Disks and Screws												
QDS300	2 Disks and 2 Screws (1 set)		1 lb	-	-	-	-	-	-			

Tip Out Bins sold separately. 1 set of disks and screws are required per Tip Out Bin system.

Clear Tip Out Bin Rails

Provide an easy and efficient way to build a high density expandable storage system. U-channel shaped rails allow Tip Out Bins to slide easily to any height. Each Tip Out Bin needs 2 disks and 2 screws (QDS300) in order to affix to all rails and frames. (Bins are sold separately)

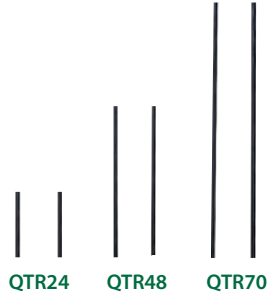

NO. OF BINS TO FIT EACH FRAME

MODEL NO.	DESCRIPTION	CTN QTY	CTN WGT	NO. OF BINS TO FIT EACH FRAME						
				QTB 302	QTB 303	QTB 304	QTB 305	QTB 306	QTB 309	
QTR24	Two 24"H Rails	1 Set	2 lbs	1	2	3	3	5	8	
QTR48	Two 48"H Rails	1 Set	4 lbs	3	5	6	7	10	16	
QTR70	Two 70"H Rails	1 Set	5 lbs	5	7	8	10	15	23	



Utilize rails when base of the first bin will sit on the floor

Clear Tip Out Bin Frames

Frames are manufactured with preset parallel distance allowing Tip Out Bins to be stacked and removed easily and efficiently. All frames have a ledge at the bottom allowing Tip Out Bins to be secured above ground level. Each Tip Out Bin needs 2 disks and 2 screws (QDS300) in order to affix to all rails and frames. (Bins are sold separately)

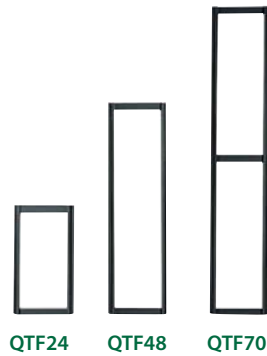

NO. OF BINS TO FIT EACH FRAME

MODEL NO.	DESCRIPTION	CTN QTY	CTN WGT	NO. OF BINS TO FIT EACH FRAME						
				QTB 302	QTB 303	QTB 304	QTB 305	QTB 306	QTB 309	
QTF24	24"H Frame	1	3 lbs	1	2	3	3	5	8	
QTF48	48"H Frame	1	5 lbs	3	5	6	7	10	16	
QTF70	70"H Frame	1	7 lbs	5	7	8	10	15	23	



Utilize frame when bins will be mounted above floor level

HOW TIP OUT BINS AFFIX TO RAILS AND FRAMES



1 Having removed transparent compartments, insert screw corresponding to screw holes in Tip Out Bin housing.



2 Insert screws and screw into disk on back of Tip Out Bin housing.



3 Insert disk into frame rails.



4 Once in place, tighten screws to affix Tip Out Bin to frame rails.



TIP OUT BIN

QLR500 Locking Rod

Keeps bins from tilting open

QTF320-42 Complete Unit

QTF320 Portable Frame (Bins Sold Separately)

MODEL NO.	DESCRIPTION	CTN QTY	CTN WGT
QTF320	24"W x 15"H Portable Frame Only	1	3 lbs
QDS300*	2 Disks and 2 Screws	1 Set	1 lb
QLR500	Locking Rod	1	1 lb
QTF320-42	Complete Frame System with Bins	1	20 lbs

*In order to attach a Tip Out Bin system to a rail, frame or floor stand, 1 set of disks and screws are required per Tip Out Bin system.



LOWEST PRICE GUARANTEED!

Available in: ● Ivory ● Gray ○ White

MODEL NO.	NO. OF BINS	NO. OF BIN CUPS
QS-304-28	28 QTB304	112
QS-305-36	36 QTB305	180
QS-306-56	56 QTB306	336
QS-309-80	80 QTB309	720
QS-305306-52	9 QTB305, 43 QTB306	303
QS-569-56	8 QTB305, 36 QTB306, 12 QTB309	364
QS-BIG-101	3 QTB302, 8 QTB303, 14 QTB304, 3 QTB305	101
QS-000	Free Standing Slider Only - NO BINS	-

*All necessary hardware included with all systems

**TIP OUT
ABOUT
BIN**

**Free Standing Slider Systems
Complete Packages**

This system features four individual panels filled with tip out bins. Two are fixed to the back side of the system and two slide easily from left to right allowing free access to all four panels. Manufactured of tough 14 gauge steel with a baked enamel finish, the overall unit measures 18"D x 48"W x 77"H. (96" widths and 26" depths are available via special order). Bins are available in 3 exterior colors.



QS-305306-52
18"D x 48"W x 77"H



QS-569-56
18"D x 48"W x 77"H



QS-BIG-101
26"D x 51-1/4"W x 77"H

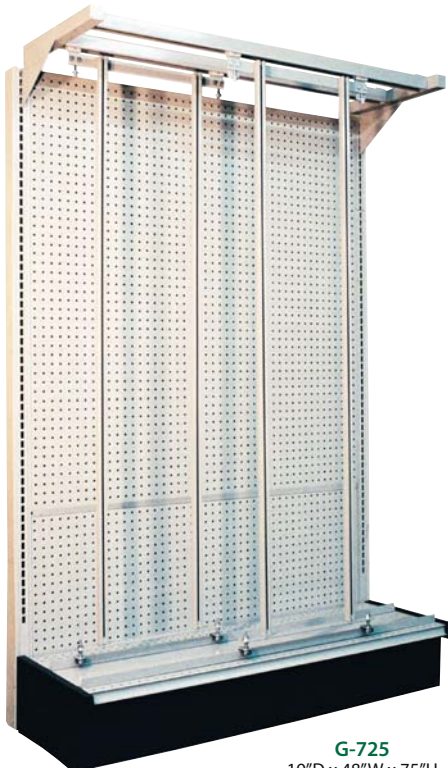

G-725
19"D x 48"W x 75"H

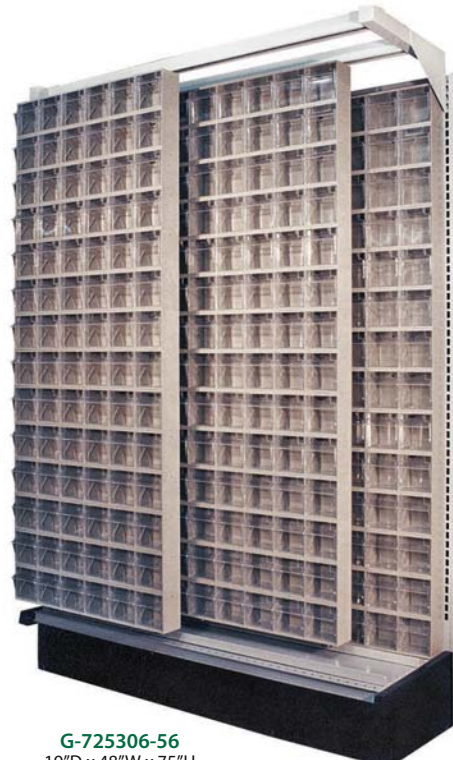

G-725306-56
19"D x 48"W x 75"H

**Gondola Slider Systems
Complete Packages**

The Gondola system provides the same versatility for orderly and efficient storage solutions in merchandising, inventory control and storing of small to medium sized parts. Slider system affixes to most standard gondolas.

Units available for purchase in the following three ways:

- Slider Frame Only (designed for fast installation on your existing 72"H Gondola). **QS-725**
- Slider Frame with Gondola (no Tip Out Bins) Overall Dimensions 19"D x 48"W x 75"H. **G-725**
- Slider Frame filled with Tip Out Bins with Gondola (five available combinations, see chart below).

Bins are available in Ivory, Gray and White.

Available in: ● Ivory ● Gray ○ White

MODEL NO.	NO. OF BINS	NO. OF BIN CUPS
QS-725	Slider Frame Only	-
G-725	Slider Frame With Gondola	-
G-725304-28	28 QTB304	112
G-725305-36	36 QTB305	180
G-725306-56	56 QTB306	336
G-725309-80	80 QTB309	720
G-725569-56	8 QTB305, 36 QTB306, 12 QTB309	364

*All necessary hardware included with all systems



Interlocking Storage Cabinets



Organize and store your small parts with these modular storage cabinets. Quantum's interlocking storage cabinets have the unique ability to interlock horizontally and vertically allowing you to customize your storage needs. Pre-drilled holes on the backside of cabinet allow for wall mounting. Cabinets are made from high impact polystyrene. Drawers are removable and will not rust or corrode. Drawers have a recessed handle and come with a slotted label holder. Drawers have seven divider slots molded in so that it may be divided into multiple compartments. Clear window allows easy identification of parts. Nine pre-configured Interlocking Storage Cabinet systems come complete with drawers, clear windows and two dividers per drawer. Additional dividers may be purchased separately. Exterior cabinets are available in Gray only.

Cabinets have the unique ability to interlock horizontally and vertically allowing you to customize your storage needs.



Cabinets available in: ● Gray
 Drawers available in: ● Blue ● Red ● Ivory ● Gray

MODEL NO.	DRAWERS PER CABINET	CTN QTY	CTN WGT
QIC-161	16 IDR201	1	10 lbs
QIC-122	12 IDR202	1	10 lbs
QIC-83	8 IDR203	1	9 lbs
QIC-64	6 IDR204	1	9 lbs
QIC-8143	8 IDR201, 4 IDR203	1	10 lbs
QIC-12123	12 IDR201, 2 IDR203	1	10 lbs
QIC-4163	4 IDR201, 6 IDR203	1	10 lbs
QIC-8224	8 IDR202, 2 IDR204	1	10 lbs
QIC-4244	4 IDR202, 4 IDR204	1	10 lbs



CABINET SYSTEMS COME COMPLETE WITH DRAWERS, CLEAR WINDOWS AND TWO DIVIDERS PER DRAWER

QIC-161
 Overall Dimensions 11-3/8"D x 11-3/4"W x 11"H
 System comes with **16 IDR201**.
 Available with Gray Cabinet and your choice of Gray, Blue, Red and Ivory for drawers.



QIC-122



QIC-83



QIC-64



QIC-8143



QIC-12123



QIC-4163



QIC-8224



QIC-4244

COLOR CODE YOUR SMALL PARTS

Cabinet Drawers



Additional Drawers may be purchased separately. All drawers come complete with a clear window. Optional dividers may be purchased separately. Available in 4 colors.

Available in: ● Blue ● Red ● Ivory ● Gray

MODEL NO.	DIMENSIONS L" x W" x H"	CTN QTY	CTN WGT	DIVIDER	CTN QTY	CTN WGT
IDR201	11" x 2-3/4" x 2-1/2"	24	9 lbs	DIV201	25	1 lb
IDR202	11" x 2-3/4" x 3-5/16"	24	12 lbs	DIV202	25	1 lb
IDR203	11" x 5-5/8" x 2-1/2"	24	14 lbs	DIV203	25	1 lb
IDR204	11" x 5-5/8" x 3-5/16"	24	22 lbs	DIV204	25	2 lbs



LOWEST PRICE GUARANTEED!

COMPLETE PACKAGES WITH BINS

Interlocking Storage Cabinet Floor Stands
Single, Double and Mobile

24 pre-configured systems provide an assortment of storage solutions to meet every need. All steel systems are formed from heavy-duty 14 gauge steel and have a smooth powder coat finish ensuring years of use. Three different heights to choose from: 24", 48" or 70". Units are single sided or double sided. Double-sided systems can be made mobile with the addition of the **QFS-400** (mobile kit). All single sided and double sided systems must be securely fastened to the floor to ensure stability. Interlocking Storage Cabinet systems come complete with drawers, clear windows and two dividers per drawer. Exterior Cabinets are available in Gray only. Drawers are available in Gray, Blue, Red and Ivory.



QIC-270-161

384
drawers

HIGH DENSITY STORAGE



QIC-124-83



QIC-248-122 + QFS-400

Cabinets available in: ● Gray Drawers available in: ● Blue ● Red ● Ivory ● Gray

COMPLETE STORAGE CABINET FLOOR STANDS							
SINGLE SIDED - 300 LB. LOAD CAPACITY				DOUBLE SIDED - 600 LB. LOAD CAPACITY			
MODEL NO.	CABINET PER FLOOR STAND	NO. OF DRAWERS	SHIP WGT	MODEL NO.	CABINET PER FLOOR STAND	NO. OF DRAWERS	SHIP WGT
24"H Single Sided Floor Stands				24"H Double Sided Floor Stands			
QIC-124-161	4 QIC-161	64	52 lbs	QIC-224-161	8 QIC-161	128	102 lbs
QIC-124-122	4 QIC-122	48	52 lbs	QIC-224-122	8 QIC-122	96	102 lbs
QIC-124-83	4 QIC-83	32	48 lbs	QIC-224-83	8 QIC-83	64	94 lbs
QIC-124-64	4 QIC-64	24	48 lbs	QIC-224-64	8 QIC-64	48	94 lbs
48"H Single Sided Floor Stands				48"H Double Sided Floor Stands			
QIC-148-161	8 QIC-161	128	100 lbs	QIC-248-161	16 QIC-161	256	196 lbs
QIC-148-122	8 QIC-122	96	100 lbs	QIC-248-122	16 QIC-122	192	196 lbs
QIC-148-83	8 QIC-83	64	92 lbs	QIC-248-83	16 QIC-83	128	180 lbs
QIC-148-64	8 QIC-64	48	92 lbs	QIC-248-64	16 QIC-64	96	180 lbs
70"H Single Sided Floor Stands				70"H Double Sided Floor Stands			
QIC-170-161	12 QIC-161	192	140 lbs	QIC-270-161	24 QIC-161	384	282 lbs
QIC-170-122	12 QIC-122	144	140 lbs	QIC-270-122	24 QIC-122	288	282 lbs
QIC-170-83	12 QIC-83	96	129 lbs	QIC-270-83	24 QIC-83	192	258 lbs
QIC-170-64	12 QIC-64	72	129 lbs	QIC-270-64	24 QIC-64	144	258 lbs

QFS-400 Kit for mobilizing double sided systems. Includes casters and handle. 500 lb. mobile load capacity.

IRONMAN - Gauge Steel Open Clip Shelving - Starter Kits

Quantum's IRONMAN Open Shelving Units are ideal for industrial and commercial storage and organization. Easy access to product, high visibility and air flow from all sides. Units are available in 18 & 20 gauge, 4 heights and 15 shelf sizes. Each starter kit includes 4 offset posts (*punched on 1" centers for easy adjustment*), one pair back sway braces, 2 pair side sway braces and selected number of shelves with corresponding hardware (*nuts and bolts for top and bottom shelf, clips for intermediate shelves*). Shelves are engineered for superior strength and are triple bent on all four sides. See shelf chart below for load capacity. Easy and quick assembly. Available in Gray.



20G-75-1836-5

18G-1236SHELF



IRONMAN - 18 & 20 Gauge Steel Shelves

Quantum's IRONMAN 18 & 20 gauge shelves are 1-1/4" thick with triple bends on all four sides.

SHELF D" x W"	MODEL NO.	LOAD CAPACITY	SHIP WGT	MODEL NO.	LOAD CAPACITY	SHIP WGT
Additional Shelves						
12" x 36"	18G-1236SHELF	800	8 lbs	20G-1236SHELF	450	6 lbs
15" x 36"	18G-1536SHELF	775	10 lbs	20G-1536SHELF	450	7 lbs
18" x 36"	18G-1836SHELF	800	11 lbs	20G-1836SHELF	450	9 lbs
24" x 36"	18G-2436SHELF	750	15 lbs	20G-2436SHELF	450	12 lbs
30" x 36"	18G-3036SHELF	700	18 lbs	20G-3036SHELF	350	14 lbs
12" x 42"	18G-1242SHELF	575	9 lbs	20G-1242SHELF	400	8 lbs
15" x 42"	18G-1542SHELF	575	11 lbs	20G-1542SHELF	400	9 lbs
18" x 42"	18G-1842SHELF	575	13 lbs	20G-1842SHELF	400	10 lbs
24" x 42"	18G-2442SHELF	575	17 lbs	20G-2442SHELF	400	12 lbs
30" x 42"	18G-3042SHELF	500	21 lbs	20G-3042SHELF	300	14 lbs
12" x 48"	18G-1248SHELF	500	11 lbs	20G-1248SHELF	350	9 lbs
15" x 48"	18G-1548SHELF	500	13 lbs	20G-1548SHELF	350	10 lbs
18" x 48"	18G-1848SHELF	500	15 lbs	20G-1848SHELF	350	11 lbs
24" x 48"	18G-2448SHELF	500	19 lbs	20G-2448SHELF	350	14 lbs
30" x 48"	18G-3048SHELF	400	24 lbs	20G-3048SHELF	250	18 lbs

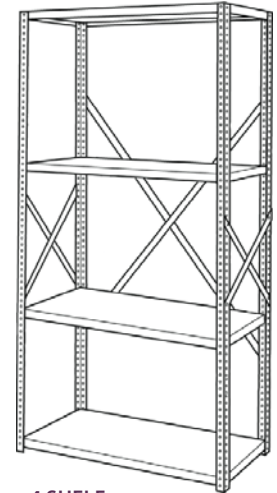

4 SHELF STARTER KITS

SHELF D" x W"	39"H			
	18 GAUGE		20 GAUGE	
MODEL NO.	SHIP WGT	MODEL NO.	SHIP WGT	
4 Shelf, 39"H Open Shelving Unit				
12" x 36"	18G-39-1236-4	45 lbs	20G-39-1236-4	40 lbs
15" x 36"	18G-39-1536-4	56 lbs	20G-39-1536-4	43 lbs
18" x 36"	18G-39-1836-4	63 lbs	20G-39-1836-4	47 lbs
24" x 36"	18G-39-2436-4	77 lbs	20G-39-2436-4	59 lbs
30" x 36"	18G-39-3036-4	91 lbs	20G-39-3036-4	69 lbs
12" x 42"	18G-39-1242-4	54 lbs	20G-39-1242-4	46 lbs
15" x 42"	18G-39-1542-4	58 lbs	20G-39-1542-4	49 lbs
18" x 42"	18G-39-1842-4	71 lbs	20G-39-1842-4	52 lbs
24" x 42"	18G-39-2442-4	87 lbs	20G-39-2442-4	63 lbs
30" x 42"	18G-39-3042-4	102 lbs	20G-39-3042-4	72 lbs
12" x 48"	18G-39-1248-4	61 lbs	20G-39-1248-4	49 lbs
15" x 48"	18G-39-1548-4	69 lbs	20G-39-1548-4	52 lbs
18" x 48"	18G-39-1848-4	77 lbs	20G-39-1848-4	59 lbs
24" x 48"	18G-39-2448-4	96 lbs	20G-39-2448-4	71 lbs
30" x 48"	18G-39-3048-4	113 lbs	20G-39-3048-4	85 lbs
5 Shelf, 39"H Open Shelving Unit				
12" x 36"	18G-39-1236-5	53 lbs	20G-39-1236-5	47 lbs
15" x 36"	18G-39-1536-5	67 lbs	20G-39-1536-5	50 lbs
18" x 36"	18G-39-1836-5	75 lbs	20G-39-1836-5	55 lbs
24" x 36"	18G-39-2436-5	93 lbs	20G-39-2436-5	70 lbs
30" x 36"	18G-39-3036-5	110 lbs	20G-39-3036-5	83 lbs
12" x 42"	18G-39-1242-5	64 lbs	20G-39-1242-5	54 lbs
15" x 42"	18G-39-1542-5	68 lbs	20G-39-1542-5	57 lbs
18" x 42"	18G-39-1842-5	85 lbs	20G-39-1842-5	62 lbs
24" x 42"	18G-39-2442-5	105 lbs	20G-39-2442-5	74 lbs
30" x 42"	18G-39-3042-5	124 lbs	20G-39-3042-5	86 lbs
12" x 48"	18G-39-1248-5	73 lbs	20G-39-1248-5	58 lbs
15" x 48"	18G-39-1548-5	83 lbs	20G-39-1548-5	62 lbs
18" x 48"	18G-39-1848-5	93 lbs	20G-39-1848-5	70 lbs
24" x 48"	18G-39-2448-5	116 lbs	20G-39-2448-5	85 lbs
30" x 48"	18G-39-3048-5	138 lbs	20G-39-3048-5	103 lbs
6 Shelf, 39"H Open Shelving Unit				
12" x 36"	18G-39-1236-6	61 lbs	20G-39-1236-6	54 lbs
15" x 36"	18G-39-1536-6	78 lbs	20G-39-1536-6	57 lbs
18" x 36"	18G-39-1836-6	87 lbs	20G-39-1836-6	63 lbs
24" x 36"	18G-39-2436-6	109 lbs	20G-39-2436-6	81 lbs
30" x 36"	18G-39-3036-6	129 lbs	20G-39-3036-6	97 lbs
12" x 42"	18G-39-1242-6	74 lbs	20G-39-1242-6	62 lbs
15" x 42"	18G-39-1542-6	78 lbs	20G-39-1542-6	65 lbs
18" x 42"	18G-39-1842-6	99 lbs	20G-39-1842-6	72 lbs
24" x 42"	18G-39-2442-6	123 lbs	20G-39-2442-6	85 lbs
30" x 42"	18G-39-3042-6	146 lbs	20G-39-3042-6	100 lbs
12" x 48"	18G-39-1248-6	85 lbs	20G-39-1248-6	67 lbs
15" x 48"	18G-39-1548-6	97 lbs	20G-39-1548-6	72 lbs
18" x 48"	18G-39-1848-6	109 lbs	20G-39-1848-6	81 lbs
24" x 48"	18G-39-2448-6	136 lbs	20G-39-2448-6	99 lbs
30" x 48"	18G-39-3048-6	163 lbs	20G-39-3048-6	120 lbs

PERFORMANCE FEATURES:

- High visibility allows for easy stocking and retrieval
- Intermediate clip shelves make for easy bolt-free assembly and adjustment
- Shelves are adjustable on 1" increments
- Sway braces on side and back provide stability

Additional Shelves and Clips available, see **pgs. 94 & 100**.
22 Gauge Shelving also available in three different sizes, see **pg. 102**.

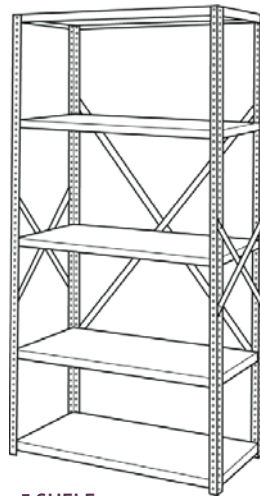

**5 SHELF
STARTER KITS**

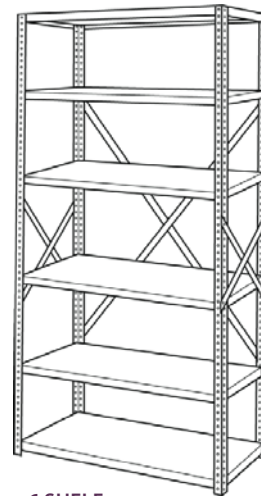

**6 SHELF
STARTER KITS**

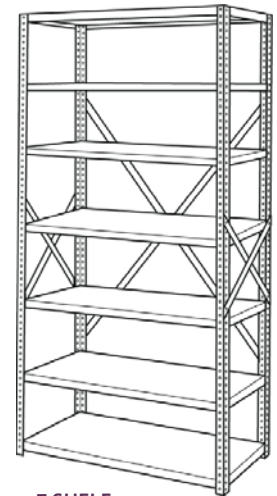

**7 SHELF
STARTER KITS**

SHELF D" x W"	75"H				87"H				99"H			
	18 GAUGE		20 GAUGE		18 GAUGE		20 GAUGE		18 GAUGE		20 GAUGE	
	MODEL NO.	SHIP WGT	MODEL NO.	SHIP WGT	MODEL NO.	SHIP WGT	MODEL NO.	SHIP WGT	MODEL NO.	SHIP WGT	MODEL NO.	SHIP WGT
5 Shelf, 75"H Open Shelving Unit				5 Shelf, 87"H Open Shelving Unit				5 Shelf, 99"H Open Shelving Unit				
12" x 36"	18G-75-1236-5	68 lbs	20G-75-1236-5	60 lbs	18G-87-1236-5	71 lbs	20G-87-1236-5	63 lbs	18G-99-1236-5	73 lbs	20G-99-1236-5	65 lbs
15" x 36"	18G-75-1536-5	80 lbs	20G-75-1536-5	63 lbs	18G-87-1536-5	83 lbs	20G-87-1536-5	66 lbs	18G-99-1536-5	85 lbs	20G-99-1536-5	68 lbs
18" x 36"	18G-75-1836-5	88 lbs	20G-75-1836-5	69 lbs	18G-87-1836-5	91 lbs	20G-87-1836-5	72 lbs	18G-99-1836-5	93 lbs	20G-99-1836-5	74 lbs
24" x 36"	18G-75-2436-5	108 lbs	20G-75-2436-5	85 lbs	18G-87-2436-5	111 lbs	20G-87-2436-5	88 lbs	18G-99-2436-5	113 lbs	20G-99-2436-5	90 lbs
30" x 36"	18G-75-3036-5	124 lbs	20G-75-3036-5	97 lbs	18G-87-3036-5	127 lbs	20G-87-3036-5	100 lbs	18G-99-3036-5	129 lbs	20G-99-3036-5	102 lbs
12" x 42"	18G-75-1242-5	80 lbs	20G-75-1242-5	68 lbs	18G-87-1242-5	83 lbs	20G-87-1242-5	72 lbs	18G-99-1242-5	85 lbs	20G-99-1242-5	74 lbs
15" x 42"	18G-75-1542-5	89 lbs	20G-75-1542-5	70 lbs	18G-87-1542-5	92 lbs	20G-87-1542-5	73 lbs	18G-99-1542-5	94 lbs	20G-99-1542-5	75 lbs
18" x 42"	18G-75-1842-5	98 lbs	20G-75-1842-5	77 lbs	18G-87-1842-5	101 lbs	20G-87-1842-5	79 lbs	18G-99-1842-5	103 lbs	20G-99-1842-5	81 lbs
24" x 42"	18G-75-2442-5	121 lbs	20G-75-2442-5	91 lbs	18G-87-2442-5	123 lbs	20G-87-2442-5	93 lbs	18G-99-2442-5	125 lbs	20G-99-2442-5	95 lbs
30" x 42"	18G-75-3042-5	139 lbs	20G-75-3042-5	101 lbs	18G-87-3042-5	142 lbs	20G-87-3042-5	105 lbs	18G-99-3042-5	144 lbs	20G-99-3042-5	106 lbs
12" x 48"	18G-75-1248-5	87 lbs	20G-75-1248-5	74 lbs	18G-87-1248-5	90 lbs	20G-87-1248-5	77 lbs	18G-99-1248-5	92 lbs	20G-99-1248-5	79 lbs
15" x 48"	18G-75-1548-5	97 lbs	20G-75-1548-5	77 lbs	18G-87-1548-5	99 lbs	20G-87-1548-5	78 lbs	18G-99-1548-5	101 lbs	20G-99-1548-5	81 lbs
18" x 48"	18G-75-1848-5	106 lbs	20G-75-1848-5	82 lbs	18G-87-1848-5	109 lbs	20G-87-1848-5	85 lbs	18G-99-1848-5	111 lbs	20G-99-1848-5	87 lbs
24" x 48"	18G-75-2448-5	132 lbs	20G-75-2448-5	101 lbs	18G-87-2448-5	135 lbs	20G-87-2448-5	103 lbs	18G-99-2448-5	137 lbs	20G-99-2448-5	105 lbs
30" x 48"	18G-75-3048-5	153 lbs	20G-75-3048-5	119 lbs	18G-87-3048-5	156 lbs	20G-87-3048-5	121 lbs	18G-99-3048-5	158 lbs	20G-99-3048-5	123 lbs
6 Shelf, 75"H Open Shelving Unit				6 Shelf, 87"H Open Shelving Unit				6 Shelf, 99"H Open Shelving Unit				
12" x 36"	18G-75-1236-6	76 lbs	20G-75-1236-6	67 lbs	18G-87-1236-6	79 lbs	20G-87-1236-6	70 lbs	18G-99-1236-6	81 lbs	20G-99-1236-6	72 lbs
15" x 36"	18G-75-1536-6	91 lbs	20G-75-1536-6	71 lbs	18G-87-1536-6	94 lbs	20G-87-1536-6	74 lbs	18G-99-1536-6	96 lbs	20G-99-1536-6	76 lbs
18" x 36"	18G-75-1836-6	100 lbs	20G-75-1836-6	76 lbs	18G-87-1836-6	104 lbs	20G-87-1836-6	80 lbs	18G-99-1836-6	106 lbs	20G-99-1836-6	82 lbs
24" x 36"	18G-75-2436-6	124 lbs	20G-75-2436-6	96 lbs	18G-87-2436-6	127 lbs	20G-87-2436-6	99 lbs	18G-99-2436-6	129 lbs	20G-99-2436-6	101 lbs
30" x 36"	18G-75-3036-6	143 lbs	20G-75-3036-6	111 lbs	18G-87-3036-6	146 lbs	20G-87-3036-6	114 lbs	18G-99-3036-6	148 lbs	20G-99-3036-6	116 lbs
12" x 42"	18G-75-1242-6	91 lbs	20G-75-1242-6	77 lbs	18G-87-1242-6	94 lbs	20G-87-1242-6	80 lbs	18G-99-1242-6	96 lbs	20G-99-1242-6	82 lbs
15" x 42"	18G-75-1542-6	101 lbs	20G-75-1542-6	79 lbs	18G-87-1542-6	104 lbs	20G-87-1542-6	81 lbs	18G-99-1542-6	106 lbs	20G-99-1542-6	83 lbs
18" x 42"	18G-75-1842-6	111 lbs	20G-75-1842-6	85 lbs	18G-87-1842-6	115 lbs	20G-87-1842-6	89 lbs	18G-99-1842-6	117 lbs	20G-99-1842-6	91 lbs
24" x 42"	18G-75-2442-6	139 lbs	20G-75-2442-6	103 lbs	18G-87-2442-6	142 lbs	20G-87-2442-6	106 lbs	18G-99-2442-6	144 lbs	20G-99-2442-6	108 lbs
30" x 42"	18G-75-3042-6	161 lbs	20G-75-3042-6	115 lbs	18G-87-3042-6	164 lbs	20G-87-3042-6	118 lbs	18G-99-3042-6	166 lbs	20G-99-3042-6	120 lbs
12" x 48"	18G-75-1248-6	99 lbs	20G-75-1248-6	83 lbs	18G-87-1248-6	102 lbs	20G-87-1248-6	86 lbs	18G-99-1248-6	104 lbs	20G-99-1248-6	88 lbs
15" x 48"	18G-75-1548-6	110 lbs	20G-75-1548-6	86 lbs	18G-87-1548-6	113 lbs	20G-87-1548-6	89 lbs	18G-99-1548-6	115 lbs	20G-99-1548-6	91 lbs
18" x 48"	18G-75-1848-6	122 lbs	20G-75-1848-6	94 lbs	18G-87-1848-6	125 lbs	20G-87-1848-6	96 lbs	18G-99-1848-6	127 lbs	20G-99-1848-6	98 lbs
24" x 48"	18G-75-2448-6	153 lbs	20G-75-2448-6	115 lbs	18G-87-2448-6	155 lbs	20G-87-2448-6	118 lbs	18G-99-2448-6	157 lbs	20G-99-2448-6	120 lbs
30" x 48"	18G-75-3048-6	178 lbs	20G-75-3048-6	136 lbs	18G-87-3048-6	181 lbs	20G-87-3048-6	139 lbs	18G-99-3048-6	183 lbs	20G-99-3048-6	141 lbs
7 Shelf, 75"H Open Shelving Unit				7 Shelf, 87"H Open Shelving Unit				7 Shelf, 99"H Open Shelving Unit				
12" x 36"	18G-75-1236-7	85 lbs	20G-75-1236-7	74 lbs	18G-87-1236-7	87 lbs	20G-87-1236-7	77 lbs	18G-99-1236-7	89 lbs	20G-99-1236-7	79 lbs
15" x 36"	18G-75-1536-7	102 lbs	20G-75-1536-7	78 lbs	18G-87-1536-7	105 lbs	20G-87-1536-7	81 lbs	18G-99-1536-7	107 lbs	20G-99-1536-7	83 lbs
18" x 36"	18G-75-1836-7	113 lbs	20G-75-1836-7	86 lbs	18G-87-1836-7	116 lbs	20G-87-1836-7	89 lbs	18G-99-1836-7	118 lbs	20G-99-1836-7	91 lbs
24" x 36"	18G-75-2436-7	140 lbs	20G-75-2436-7	109 lbs	18G-87-2436-7	143 lbs	20G-87-2436-7	110 lbs	18G-99-2436-7	144 lbs	20G-99-2436-7	112 lbs
30" x 36"	18G-75-3036-7	162 lbs	20G-75-3036-7	125 lbs	18G-87-3036-7	165 lbs	20G-87-3036-7	128 lbs	18G-99-3036-7	167 lbs	20G-99-3036-7	130 lbs
12" x 42"	18G-75-1242-7	102 lbs	20G-75-1242-7	86 lbs	18G-87-1242-7	105 lbs	20G-87-1242-7	89 lbs	18G-99-1242-7	107 lbs	20G-99-1242-7	91 lbs
15" x 42"	18G-75-1542-7	114 lbs	20G-75-1542-7	87 lbs	18G-87-1542-7	117 lbs	20G-87-1542-7	90 lbs	18G-99-1542-7	119 lbs	20G-99-1542-7	92 lbs
18" x 42"	18G-75-1842-7	126 lbs	20G-75-1842-7	96 lbs	18G-87-1842-7	129 lbs	20G-87-1842-7	99 lbs	18G-99-1842-7	131 lbs	20G-99-1842-7	101 lbs
24" x 42"	18G-75-2442-7	157 lbs	20G-75-2442-7	115 lbs	18G-87-2442-7	160 lbs	20G-87-2442-7	118 lbs	18G-99-2442-7	162 lbs	20G-99-2442-7	120 lbs
30" x 42"	18G-75-3042-7	183 lbs	20G-75-3042-7	130 lbs	18G-87-3042-7	186 lbs	20G-87-3042-7	133 lbs	18G-99-3042-7	188 lbs	20G-99-3042-7	135 lbs
12" x 48"	18G-75-1248-7	111 lbs	20G-75-1248-7	93 lbs	18G-87-1248-7	114 lbs	20G-87-1248-7	96 lbs	18G-99-1248-7	116 lbs	20G-99-1248-7	98 lbs
15" x 48"	18G-75-1548-7	124 lbs	20G-75-1548-7	96 lbs	18G-87-1548-7	127 lbs	20G-87-1548-7	99 lbs	18G-99-1548-7	129 lbs	20G-99-1548-7	101 lbs
18" x 48"	18G-75-1848-7	138 lbs	20G-75-1848-7	105 lbs	18G-87-1848-7	141 lbs	20G-87-1848-7	108 lbs	18G-99-1848-7	143 lbs	20G-99-1848-7	110 lbs
24" x 48"	18G-75-2448-7	173 lbs	20G-75-2448-7	129 lbs	18G-87-2448-7	176 lbs	20G-87-2448-7	132 lbs	18G-99-2448-7	178 lbs	20G-99-2448-7	134 lbs
30" x 48"	18G-75-3048-7	203 lbs	20G-75-3048-7	154 lbs	18G-87-3048-7	205 lbs	20G-87-3048-7	157 lbs	18G-99-3048-7	207 lbs	20G-99-3048-7	159 lbs

IRONMAN - Gauge Steel Open Clip Shelving - Add-On Kits

Easy access to product, high visibility and air flow from all sides. Units are available in 18 & 20 gauge, 4 heights and 15 shelf sizes. Each add-on unit includes 2 offset posts (punched on 1" centers for easy adjustment), one beaded post, one pair back sway braces, one pair side sway braces and selected number of shelves with corresponding hardware (nuts and bolts for top and bottom shelves, clips for intermediate shelves). Shelves are engineered for superior strength and are triple bent on all four sides. See shelf chart on pg. 94 for load capacity. Easy and quick assembly. Available in Gray.

**EASY ACCESS TO PRODUCT,
HIGH VISIBILITY AND AIR FLOW
FROM ALL SIDES**



20G-75-1836-5 + AD20G-75-1836-5

IRONMAN - Steel Posts

Quantum's IRONMAN Offset posts are 14 gauge 1-1/4" x 1-29/32" punched on 1" centers and can be used with shelf clips or nut and bolts. Angle posts are 14 gauge, 1-1/4" x 1-1/4" punched on 1" centers and can be used with nuts and bolts. Beaded posts are 14 gauge, 1-29/32" x 1-29/32" punched on 1" centers and can be used with shelf clips or nut and bolts. Beaded posts are used for continuous runs of shelving.



ANGLE POST



BEADED POST



OFFSET POST

MODEL NO.	POST HEIGHT	SHIP WGT
Offset Posts		
OP-39	39"	14 lbs
OP-75	75"	22 lbs
OP-87	87"	26 lbs
OP-99	99"	30 lbs
OP-123	123"	38 lbs
OP-147	147"	42 lbs
Angle Posts		
AP-39	39"	14 lbs
AP-75	75"	26 lbs
Beaded Posts		
BP-39	39"	11 lbs
BP-75	75"	17 lbs
BP-87	87"	20 lbs
BP-99	99"	23 lbs
BP-123	123"	29 lbs
BP-147	147"	32 lbs

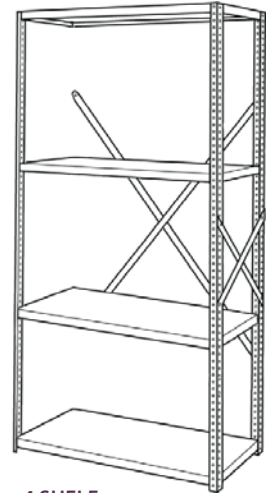

**4 SHELF
ADD-ON KITS**

SHELF D" x W"	39"H			
	18 GAUGE		20 GAUGE	
MODEL NO.	SHIP WGT	MODEL NO.	SHIP WGT	
4 Shelf, 39"H Open Shelving Unit				
12" x 36"	AD18G-39-1236-4	40 lbs	AD20G-39-1236-4	35 lbs
15" x 36"	AD18G-39-1536-4	51 lbs	AD20G-39-1536-4	38 lbs
18" x 36"	AD18G-39-1836-4	57 lbs	AD20G-39-1836-4	42 lbs
24" x 36"	AD18G-39-2436-4	72 lbs	AD20G-39-2436-4	54 lbs
30" x 36"	AD18G-39-3036-4	86 lbs	AD20G-39-3036-4	64 lbs
12" x 42"	AD18G-39-1242-4	49 lbs	AD20G-39-1242-4	41 lbs
15" x 42"	AD18G-39-1542-4	53 lbs	AD20G-39-1542-4	44 lbs
18" x 42"	AD18G-39-1842-4	66 lbs	AD20G-39-1842-4	47 lbs
24" x 42"	AD18G-39-2442-4	82 lbs	AD20G-39-2442-4	58 lbs
30" x 42"	AD18G-39-3042-4	97 lbs	AD20G-39-3042-4	67 lbs
12" x 48"	AD18G-39-1248-4	56 lbs	AD20G-39-1248-4	44 lbs
15" x 48"	AD18G-39-1548-4	64 lbs	AD20G-39-1548-4	47 lbs
18" x 48"	AD18G-39-1848-4	72 lbs	AD20G-39-1848-4	54 lbs
24" x 48"	AD18G-39-2448-4	91 lbs	AD20G-39-2448-4	66 lbs
30" x 48"	AD18G-39-3048-4	108 lbs	AD20G-39-3048-4	80 lbs
5 Shelf, 39"H Open Shelving Unit				
12" x 36"	AD18G-39-1236-5	48 lbs	AD20G-39-1236-5	42 lbs
15" x 36"	AD18G-39-1536-5	62 lbs	AD20G-39-1536-5	45 lbs
18" x 36"	AD18G-39-1836-5	70 lbs	AD20G-39-1836-5	50 lbs
24" x 36"	AD18G-39-2436-5	88 lbs	AD20G-39-2436-5	65 lbs
30" x 36"	AD18G-39-3036-5	105 lbs	AD20G-39-3036-5	78 lbs
12" x 42"	AD18G-39-1242-5	59 lbs	AD20G-39-1242-5	49 lbs
15" x 42"	AD18G-39-1542-5	63 lbs	AD20G-39-1542-5	52 lbs
18" x 42"	AD18G-39-1842-5	80 lbs	AD20G-39-1842-5	57 lbs
24" x 42"	AD18G-39-2442-5	100 lbs	AD20G-39-2442-5	69 lbs
30" x 42"	AD18G-39-3042-5	119 lbs	AD20G-39-3042-5	81 lbs
12" x 48"	AD18G-39-1248-5	68 lbs	AD20G-39-1248-5	53 lbs
15" x 48"	AD18G-39-1548-5	78 lbs	AD20G-39-1548-5	57 lbs
18" x 48"	AD18G-39-1848-5	88 lbs	AD20G-39-1848-5	65 lbs
24" x 48"	AD18G-39-2448-5	111 lbs	AD20G-39-2448-5	80 lbs
30" x 48"	AD18G-39-3048-5	133 lbs	AD20G-39-3048-5	98 lbs
6 Shelf, 39"H Open Shelving Unit				
12" x 36"	AD18G-39-1236-6	56 lbs	AD20G-39-1236-6	49 lbs
15" x 36"	AD18G-39-1536-6	73 lbs	AD20G-39-1536-6	52 lbs
18" x 36"	AD18G-39-1836-6	82 lbs	AD20G-39-1836-6	58 lbs
24" x 36"	AD18G-39-2436-6	104 lbs	AD20G-39-2436-6	76 lbs
30" x 36"	AD18G-39-3036-6	124 lbs	AD20G-39-3036-6	92 lbs
12" x 42"	AD18G-39-1242-6	69 lbs	AD20G-39-1242-6	57 lbs
15" x 42"	AD18G-39-1542-6	73 lbs	AD20G-39-1542-6	60 lbs
18" x 42"	AD18G-39-1842-6	94 lbs	AD20G-39-1842-6	57 lbs
24" x 42"	AD18G-39-2442-6	118 lbs	AD20G-39-2442-6	80 lbs
30" x 42"	AD18G-39-3042-6	141 lbs	AD20G-39-3042-6	95 lbs
12" x 48"	AD18G-39-1248-6	80 lbs	AD20G-39-1248-6	62 lbs
15" x 48"	AD18G-39-1548-6	92 lbs	AD20G-39-1548-6	57 lbs
18" x 48"	AD18G-39-1848-6	104 lbs	AD20G-39-1848-6	76 lbs
24" x 48"	AD18G-39-2448-6	131 lbs	AD20G-39-2448-6	94 lbs
30" x 48"	AD18G-39-3048-6	158 lbs	AD20G-39-3048-6	115 lbs

PERFORMANCE FEATURES:

- High visibility allows for easy stocking and retrieval
- Intermediate clip shelves make for easy bolt-free assembly and adjustment
- Shelves are adjustable on 1" increments
- Sway braces on side and back provide stability

Additional Shelves and Clips available, see **pgs. 94 & 100**.
22 Gauge Shelving also available in three different sizes, see **pg.102**.

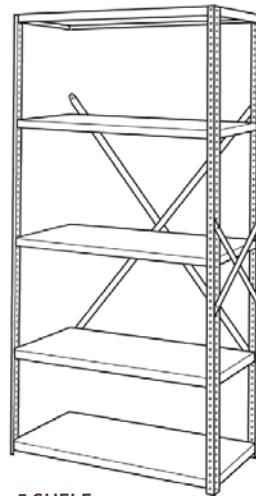

**5 SHELF
ADD-ON KITS**

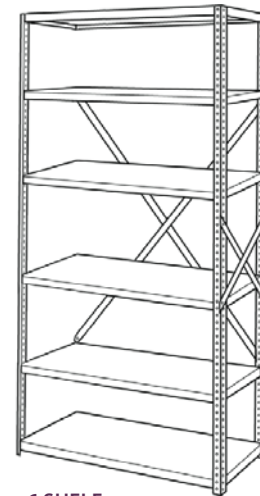

**6 SHELF
ADD-ON KITS**

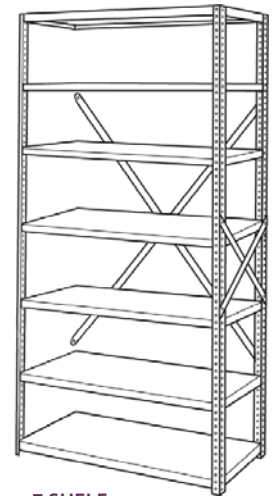

**7 SHELF
ADD-ON KITS**

SHELF D" x W"	75"H				87"H				99"H			
	18 GAUGE		20 GAUGE		18 GAUGE		20 GAUGE		18 GAUGE		20 GAUGE	
	MODEL NO.	SHIP WGT	MODEL NO.	SHIP WGT	MODEL NO.	SHIP WGT	MODEL NO.	SHIP WGT	MODEL NO.	SHIP WGT	MODEL NO.	SHIP WGT
5 Shelf, 75"H Open Shelving Unit				5 Shelf, 87"H Open Shelving Unit				5 Shelf, 99"H Open Shelving Unit				
12" x 36"	AD18G-75-1236-5	61 lbs	AD20G-75-1236-5	53 lbs	AD18G-87-1236-5	63 lbs	AD20G-87-1236-5	55 lbs	AD18G-99-1236-5	64 lbs	AD20G-99-1236-5	56 lbs
15" x 36"	AD18G-75-1536-5	73 lbs	AD20G-75-1536-5	56 lbs	AD18G-87-1536-5	75 lbs	AD20G-87-1536-5	58 lbs	AD18G-99-1536-5	76 lbs	AD20G-99-1536-5	59 lbs
18" x 36"	AD18G-75-1836-5	81 lbs	AD20G-75-1836-5	62 lbs	AD18G-87-1836-5	83 lbs	AD20G-87-1836-5	64 lbs	AD18G-99-1836-5	84 lbs	AD20G-99-1836-5	65 lbs
24" x 36"	AD18G-75-2436-5	101 lbs	AD20G-75-2436-5	78 lbs	AD18G-87-2436-5	103 lbs	AD20G-87-2436-5	80 lbs	AD18G-99-2436-5	104 lbs	AD20G-99-2436-5	81 lbs
30" x 36"	AD18G-75-3036-5	117 lbs	AD20G-75-3036-5	90 lbs	AD18G-87-3036-5	119 lbs	AD20G-87-3036-5	92 lbs	AD18G-99-3036-5	120 lbs	AD20G-99-3036-5	93 lbs
12" x 42"	AD18G-75-1242-5	73 lbs	AD20G-75-1242-5	61 lbs	AD18G-87-1242-5	75 lbs	AD20G-87-1242-5	64 lbs	AD18G-99-1242-5	76 lbs	AD20G-99-1242-5	65 lbs
15" x 42"	AD18G-75-1542-5	82 lbs	AD20G-75-1542-5	63 lbs	AD18G-87-1542-5	84 lbs	AD20G-87-1542-5	65 lbs	AD18G-99-1542-5	85 lbs	AD20G-99-1542-5	66 lbs
18" x 42"	AD18G-75-1842-5	91 lbs	AD20G-75-1842-5	70 lbs	AD18G-87-1842-5	93 lbs	AD20G-87-1842-5	71 lbs	AD18G-99-1842-5	94 lbs	AD20G-99-1842-5	72 lbs
24" x 42"	AD18G-75-2442-5	114 lbs	AD20G-75-2442-5	84 lbs	AD18G-87-2442-5	115 lbs	AD20G-87-2442-5	85 lbs	AD18G-99-2442-5	116 lbs	AD20G-99-2442-5	86 lbs
30" x 42"	AD18G-75-3042-5	132 lbs	AD20G-75-3042-5	94 lbs	AD18G-87-3042-5	134 lbs	AD20G-87-3042-5	97 lbs	AD18G-99-3042-5	135 lbs	AD20G-99-3042-5	97 lbs
12" x 48"	AD18G-75-1248-5	80 lbs	AD20G-75-1248-5	67 lbs	AD18G-87-1248-5	82 lbs	AD20G-87-1248-5	69 lbs	AD18G-99-1248-5	83 lbs	AD20G-99-1248-5	70 lbs
15" x 48"	AD18G-75-1548-5	90 lbs	AD20G-75-1548-5	70 lbs	AD18G-87-1548-5	91 lbs	AD20G-87-1548-5	70 lbs	AD18G-99-1548-5	92 lbs	AD20G-99-1548-5	72 lbs
18" x 48"	AD18G-75-1848-5	99 lbs	AD20G-75-1848-5	75 lbs	AD18G-87-1848-5	101 lbs	AD20G-87-1848-5	77 lbs	AD18G-99-1848-5	102 lbs	AD20G-99-1848-5	78 lbs
24" x 48"	AD18G-75-2448-5	125 lbs	AD20G-75-2448-5	94 lbs	AD18G-87-2448-5	127 lbs	AD20G-87-2448-5	95 lbs	AD18G-99-2448-5	128 lbs	AD20G-99-2448-5	96 lbs
30" x 48"	AD18G-75-3048-5	146 lbs	AD20G-75-3048-5	112 lbs	AD18G-87-3048-5	148 lbs	AD20G-87-3048-5	113 lbs	AD18G-99-3048-5	149 lbs	AD20G-99-3048-5	114 lbs
6 Shelf, 75"H Open Shelving Unit				6 Shelf, 87"H Open Shelving Unit				6 Shelf, 99"H Open Shelving Unit				
12" x 36"	AD18G-75-1236-6	69 lbs	AD20G-75-1236-6	60 lbs	AD18G-87-1236-6	71 lbs	AD20G-87-1236-6	62 lbs	AD18G-99-1236-6	72 lbs	AD20G-99-1236-6	63 lbs
15" x 36"	AD18G-75-1536-6	84 lbs	AD20G-75-1536-6	64 lbs	AD18G-87-1536-6	86 lbs	AD20G-87-1536-6	66 lbs	AD18G-99-1536-6	87 lbs	AD20G-99-1536-6	67 lbs
18" x 36"	AD18G-75-1836-6	93 lbs	AD20G-75-1836-6	69 lbs	AD18G-87-1836-6	96 lbs	AD20G-87-1836-6	72 lbs	AD18G-99-1836-6	97 lbs	AD20G-99-1836-6	73 lbs
24" x 36"	AD18G-75-2436-6	117 lbs	AD20G-75-2436-6	89 lbs	AD18G-87-2436-6	119 lbs	AD20G-87-2436-6	91 lbs	AD18G-99-2436-6	120 lbs	AD20G-99-2436-6	92 lbs
30" x 36"	AD18G-75-3036-6	136 lbs	AD20G-75-3036-6	104 lbs	AD18G-87-3036-6	138 lbs	AD20G-87-3036-6	106 lbs	AD18G-99-3036-6	139 lbs	AD20G-99-3036-6	107 lbs
12" x 42"	AD18G-75-1242-6	84 lbs	AD20G-75-1242-6	70 lbs	AD18G-87-1242-6	86 lbs	AD20G-87-1242-6	72 lbs	AD18G-99-1242-6	87 lbs	AD20G-99-1242-6	73 lbs
15" x 42"	AD18G-75-1542-6	94 lbs	AD20G-75-1542-6	72 lbs	AD18G-87-1542-6	96 lbs	AD20G-87-1542-6	73 lbs	AD18G-99-1542-6	97 lbs	AD20G-99-1542-6	74 lbs
18" x 42"	AD18G-75-1842-6	104 lbs	AD20G-75-1842-6	78 lbs	AD18G-87-1842-6	107 lbs	AD20G-87-1842-6	81 lbs	AD18G-99-1842-6	108 lbs	AD20G-99-1842-6	82 lbs
24" x 42"	AD18G-75-2442-6	132 lbs	AD20G-75-2442-6	96 lbs	AD18G-87-2442-6	134 lbs	AD20G-87-2442-6	98 lbs	AD18G-99-2442-6	135 lbs	AD20G-99-2442-6	99 lbs
30" x 42"	AD18G-75-3042-6	154 lbs	AD20G-75-3042-6	108 lbs	AD18G-87-3042-6	156 lbs	AD20G-87-3042-6	110 lbs	AD18G-99-3042-6	157 lbs	AD20G-99-3042-6	111 lbs
12" x 48"	AD18G-75-1248-6	92 lbs	AD20G-75-1248-6	76 lbs	AD18G-87-1248-6	94 lbs	AD20G-87-1248-6	78 lbs	AD18G-99-1248-6	95 lbs	AD20G-99-1248-6	79 lbs
15" x 48"	AD18G-75-1548-6	103 lbs	AD20G-75-1548-6	79 lbs	AD18G-87-1548-6	105 lbs	AD20G-87-1548-6	81 lbs	AD18G-99-1548-6	106 lbs	AD20G-99-1548-6	82 lbs
18" x 48"	AD18G-75-1848-6	115 lbs	AD20G-75-1848-6	87 lbs	AD18G-87-1848-6	117 lbs	AD20G-87-1848-6	88 lbs	AD18G-99-1848-6	118 lbs	AD20G-99-1848-6	89 lbs
24" x 48"	AD18G-75-2448-6	146 lbs	AD20G-75-2448-6	108 lbs	AD18G-87-2448-6	147 lbs	AD20G-87-2448-6	110 lbs	AD18G-99-2448-6	148 lbs	AD20G-99-2448-6	111 lbs
30" x 48"	AD18G-75-3048-6	171 lbs	AD20G-75-3048-6	129 lbs	AD18G-87-3048-6	173 lbs	AD20G-87-3048-6	131 lbs	AD18G-99-3048-6	174 lbs	AD20G-99-3048-6	132 lbs
7 Shelf, 75"H Open Shelving Unit				7 Shelf, 87"H Open Shelving Unit				7 Shelf, 99"H Open Shelving Unit				
12" x 36"	AD18G-75-1236-7	78 lbs	AD20G-75-1236-7	67 lbs	AD18G-87-1236-7	79 lbs	AD20G-87-1236-7	69 lbs	AD18G-99-1236-7	80 lbs	AD20G-99-1236-7	70 lbs
15" x 36"	AD18G-75-1536-7	95 lbs	AD20G-75-1536-7	71 lbs	AD18G-87-1536-7	97 lbs	AD20G-87-1536-7	73 lbs	AD18G-99-1536-7	98 lbs	AD20G-99-1536-7	74 lbs
18" x 36"	AD18G-75-1836-7	106 lbs	AD20G-75-1836-7	79 lbs	AD18G-87-1836-7	108 lbs	AD20G-87-1836-7	81 lbs	AD18G-99-1836-7	109 lbs	AD20G-99-1836-7	82 lbs
24" x 36"	AD18G-75-2436-7	133 lbs	AD20G-75-2436-7	102 lbs	AD18G-87-2436-7	135 lbs	AD20G-87-2436-7	102 lbs	AD18G-99-2436-7	135 lbs	AD20G-99-2436-7	103 lbs
30" x 36"	AD18G-75-3036-7	155 lbs	AD20G-75-3036-7	118 lbs	AD18G-87-3036-7	157 lbs	AD20G-87-3036-7	120 lbs	AD18G-99-3036-7	158 lbs	AD20G-99-3036-7	121 lbs
12" x 42"	AD18G-75-1242-7	95 lbs	AD20G-75-1242-7	79 lbs	AD18G-87-1242-7	97 lbs	AD20G-87-1242-7	81 lbs	AD18G-99-1242-7	98 lbs	AD20G-99-1242-7	82 lbs
15" x 42"	AD18G-75-1542-7	107 lbs	AD20G-75-1542-7	80 lbs	AD18G-87-1542-7	109 lbs	AD20G-87-1542-7	82 lbs	AD18G-99-1542-7	110 lbs	AD20G-99-1542-7	83 lbs
18" x 42"	AD18G-75-1842-7	119 lbs	AD20G-75-1842-7	89 lbs	AD18G-87-1842-7	121 lbs	AD20G-87-1842-7	91 lbs	AD18G-99-1842-7	122 lbs	AD20G-99-1842-7	92 lbs
24" x 42"	AD18G-75-2442-7	150 lbs	AD20G-75-2442-7	108 lbs	AD18G-87-2442-7	152 lbs	AD20G-87-2442-7	110 lbs	AD18G-99-2442-7	153 lbs	AD20G-99-2442-7	111 lbs
30" x 42"	AD18G-75-3042-7	176 lbs	AD20G-75-3042-7	123 lbs	AD18G-87-3042-7	178 lbs	AD20G-87-3042-7	125 lbs	AD18G-99-3042-7	179 lbs	AD20G-99-3042-7	126 lbs
12" x 48"	AD18G-75-1248-7	104 lbs	AD20G-75-1248-7	86 lbs	AD18G-87-1248-7	106 lbs	AD20G-87-1248-7	88 lbs	AD18G-99-1248-7	107 lbs	AD20G-99-1248-7	89 lbs
15" x 48"	AD18G-75-1548-7	117 lbs	AD20G-75-1548-7	89 lbs	AD18G-87-1548-7	119 lbs	AD20G-87-1548-7	91 lbs	AD18G-99-1548-7	120 lbs	AD20G-99-1548-7	92 lbs
18" x 48"	AD18G-75-1848-7	126 lbs	AD20G-75-1848-7	98 lbs	AD18G-87-1848-7	133 lbs	AD20G-87-1848-7	100 lbs	AD18G-99-1848-7	134 lbs	AD20G-99-1848-7	101 lbs
24" x 48"	AD18G-75-2448-7	166 lbs	AD20G-75-2448-7	122 lbs	AD18G-87-2448-7	168 lbs	AD20G-87-2448-7	124 lbs	AD18G-99-2448-7	169 lbs	AD20G-99-2448-7	125 lbs
30" x 48"	AD18G-75-3048-7	196 lbs	AD20G-75-3048-7	147 lbs	AD18G-87-3048-7	197 lbs	AD20G-87-3048-7	149 lbs	AD18G-99-3048-7	198 lbs	AD20G-99-3048-7	150 lbs

IRONMAN - Gauge Steel Closed Clip Shelving - Starter Kits

Quantum's IRONMAN Closed Shelving Units are ideal for industrial and commercial storage and organization. Closed shelving provides extra protection from dirt & dust, creates separation between areas and prevents product from falling off sides or back of unit. Units are available in 18 & 20 gauge, 4 heights and 15 shelf sizes. Each starter unit includes 4 offset posts (punched on 1" centers for easy adjustment), one back panel, 2 side panels and selected number of shelves with corresponding hardware (nuts and bolts for top and bottom shelves, clips for intermediate shelves). See shelf chart on **pg. 94** for load weight capacity. Easy and quick assembly. Available in Gray.

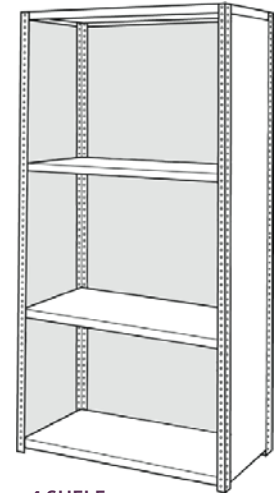

**4 SHELF
STARTER KITS**

EXTRA PROTECTION FROM DIRT & DUST, PREVENTS PRODUCT FROM FALLING OFF SIDES OR BACK OF UNIT



CL20G-75-1836-5

IRONMAN - Back and Side Panels

Offset back and side panels to be used with offset posts. Back and side panels are designed for extra protection against dirt & dust, creates separation between areas and provides a more orderly appearance. Back and side panels replace back and side sway braces. Order two side panels and one back panel per unit.

MODEL NO.	SHIP WGT
Side Panels	
SP-1239	4 lbs
SP-1539	5 lbs
SP-1839	6 lbs
SP-2439	9 lbs
SP-3039	10 lbs
SP-1275	8 lbs
SP-1575	10 lbs
SP-1875	12 lbs
SP-2475	18 lbs
SP-3075	20 lbs
SP-1287	12 lbs
SP-1587	15 lbs
SP-1887	18 lbs
SP-2487	27 lbs
SP-3087	30 lbs
SP-1299	12 lbs
SP-1599	15 lbs
SP-1899	18 lbs
SP-2499	27 lbs
SP-3099	30 lbs
Back Panels	
BP-3639	13 lbs
BP-4239	15 lbs
BP-4839	17 lbs
BP-3675	26 lbs
BP-4275	30 lbs
BP-4875	34 lbs
BP-3687	39 lbs
BP-4287	45 lbs
BP-4887	51 lbs
BP-3699	39 lbs
BP-4299	45 lbs
BP-4899	51 lbs

SHELF D" x W"	39"H			
	18 GAUGE		20 GAUGE	
MODEL NO.	SHIP WGT	MODEL NO.	SHIP WGT	
4 Shelf, 39"H Closed Shelving Unit				
12" x 36"	CL18G-39-1236-4 60 lbs	CL20G-39-1236-4 55 lbs		
15" x 36"	CL18G-39-1536-4 72 lbs	CL20G-39-1536-4 59 lbs		
18" x 36"	CL18G-39-1836-4 82 lbs	CL20G-39-1836-4 66 lbs		
24" x 36"	CL18G-39-2436-4 98 lbs	CL20G-39-2436-4 80 lbs		
30" x 36"	CL18G-39-3036-4 114 lbs	CL20G-39-3036-4 92 lbs		
12" x 42"	CL18G-39-1242-4 71 lbs	CL20G-39-1242-4 63 lbs		
15" x 42"	CL18G-39-1542-4 76 lbs	CL20G-39-1542-4 67 lbs		
18" x 42"	CL18G-39-1842-4 91 lbs	CL20G-39-1842-4 72 lbs		
24" x 42"	CL18G-39-2442-4 110 lbs	CL20G-39-2442-4 86 lbs		
30" x 42"	CL18G-39-3042-4 128 lbs	CL20G-39-3042-4 98 lbs		
12" x 48"	CL18G-39-1248-4 82 lbs	CL20G-39-1248-4 70 lbs		
15" x 48"	CL18G-39-1548-4 91 lbs	CL20G-39-1548-4 74 lbs		
18" x 48"	CL18G-39-1848-4 100 lbs	CL20G-39-1848-4 82 lbs		
24" x 48"	CL18G-39-2448-4 122 lbs	CL20G-39-2448-4 97 lbs		
30" x 48"	CL18G-39-3048-4 141 lbs	CL20G-39-3048-4 113 lbs		
5 Shelf, 39"H Closed Shelving Unit				
12" x 36"	CL18G-39-1236-5 68 lbs	CL20G-39-1236-5 62 lbs		
15" x 36"	CL18G-39-1536-5 83 lbs	CL20G-39-1536-5 66 lbs		
18" x 36"	CL18G-39-1836-5 94 lbs	CL20G-39-1836-5 74 lbs		
24" x 36"	CL18G-39-2436-5 114 lbs	CL20G-39-2436-5 91 lbs		
30" x 36"	CL18G-39-3036-5 133 lbs	CL20G-39-3036-5 106 lbs		
12" x 42"	CL18G-39-1242-5 81 lbs	CL20G-39-1242-5 71 lbs		
15" x 42"	CL18G-39-1542-5 86 lbs	CL20G-39-1542-5 75 lbs		
18" x 42"	CL18G-39-1842-5 105 lbs	CL20G-39-1842-5 82 lbs		
24" x 42"	CL18G-39-2442-5 128 lbs	CL20G-39-2442-5 97 lbs		
30" x 42"	CL18G-39-3042-5 150 lbs	CL20G-39-3042-5 112 lbs		
12" x 48"	CL18G-39-1248-5 94 lbs	CL20G-39-1248-5 79 lbs		
15" x 48"	CL18G-39-1548-5 105 lbs	CL20G-39-1548-5 84 lbs		
18" x 48"	CL18G-39-1848-5 116 lbs	CL20G-39-1848-5 93 lbs		
24" x 48"	CL18G-39-2448-5 147 lbs	CL20G-39-2448-5 111 lbs		
30" x 48"	CL18G-39-3048-5 166 lbs	CL20G-39-3048-5 131 lbs		
6 Shelf, 39"H Closed Shelving Unit				
12" x 36"	CL18G-39-1236-6 76 lbs	CL20G-39-1236-6 69 lbs		
15" x 36"	CL18G-39-1536-6 94 lbs	CL20G-39-1536-6 73 lbs		
18" x 36"	CL18G-39-1836-6 106 lbs	CL20G-39-1836-6 82 lbs		
24" x 36"	CL18G-39-2436-6 130 lbs	CL20G-39-2436-6 102 lbs		
30" x 36"	CL18G-39-3036-6 152 lbs	CL20G-39-3036-6 120 lbs		
12" x 42"	CL18G-39-1242-6 91 lbs	CL20G-39-1242-6 79 lbs		
15" x 42"	CL18G-39-1542-6 96 lbs	CL20G-39-1542-6 83 lbs		
18" x 42"	CL18G-39-1842-6 119 lbs	CL20G-39-1842-6 92 lbs		
24" x 42"	CL18G-39-2442-6 146 lbs	CL20G-39-2442-6 108 lbs		
30" x 42"	CL18G-39-3042-6 172 lbs	CL20G-39-3042-6 126 lbs		
12" x 48"	CL18G-39-1248-6 106 lbs	CL20G-39-1248-6 88 lbs		
15" x 48"	CL18G-39-1548-6 119 lbs	CL20G-39-1548-6 94 lbs		
18" x 48"	CL18G-39-1848-6 132 lbs	CL20G-39-1848-6 104 lbs		
24" x 48"	CL18G-39-2448-6 162 lbs	CL20G-39-2448-6 125 lbs		
30" x 48"	CL18G-39-3048-6 191 lbs	CL20G-39-3048-6 148 lbs		

PERFORMANCE FEATURES:

- Provides extra protection against dirt and dust
- Creates separation between areas
- Clip shelves make for easy bolt-free assembly and adjustment
- Shelves are adjustable on 1" increments
- Panels on side and back provide stability

Additional Shelves and Clips available, see **pgs. 94 & 100**.
22 Gauge Shelving also available in three different sizes, see **pg. 102**.

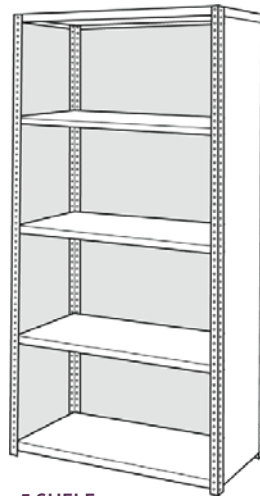

**5 SHELF
STARTER KITS**

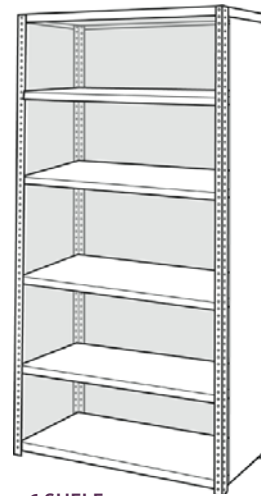

**6 SHELF
STARTER KITS**

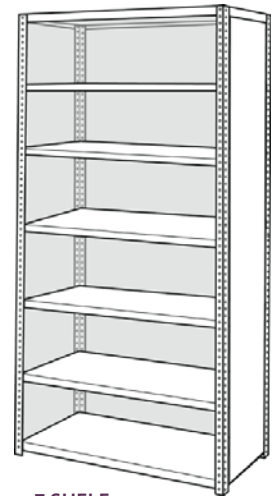

**7 SHELF
STARTER KITS**

SHELF D" x W"	75"H				87"H				99"H			
	18 GAUGE		20 GAUGE		18 GAUGE		20 GAUGE		18 GAUGE		20 GAUGE	
	MODEL NO.	SHIP WGT	MODEL NO.	SHIP WGT	MODEL NO.	SHIP WGT	MODEL NO.	SHIP WGT	MODEL NO.	SHIP WGT	MODEL NO.	SHIP WGT
5 Shelf, 75"H Open Shelving Unit												
12" x 36"	CL18G-75-1236-5	98 lbs	CL20G-75-1236-5	90 lbs	CL18G-87-1236-5	116 lbs	CL20G-87-1236-5	108 lbs	CL18G-99-1236-5	118 lbs	CL20G-99-1236-5	110 lbs
15" x 36"	CL18G-75-1536-5	112 lbs	CL20G-75-1536-5	95 lbs	CL18G-87-1536-5	131 lbs	CL20G-87-1536-5	114 lbs	CL18G-99-1536-5	133 lbs	CL20G-99-1536-5	116 lbs
18" x 36"	CL18G-75-1836-5	126 lbs	CL20G-75-1836-5	107 lbs	CL18G-87-1836-5	148 lbs	CL20G-87-1836-5	129 lbs	CL18G-99-1836-5	150 lbs	CL20G-99-1836-5	131 lbs
24" x 36"	CL18G-75-2436-5	150 lbs	CL20G-75-2436-5	127 lbs	CL18G-87-2436-5	174 lbs	CL20G-87-2436-5	151 lbs	CL18G-99-2436-5	176 lbs	CL20G-99-2436-5	153 lbs
30" x 36"	CL18G-75-3036-5	170 lbs	CL20G-75-3036-5	143 lbs	CL18G-87-3036-5	196 lbs	CL20G-87-3036-5	169 lbs	CL18G-99-3036-5	198 lbs	CL20G-99-3036-5	171 lbs
12" x 42"	CL18G-75-1242-5	114 lbs	CL20G-75-1242-5	102 lbs	CL18G-87-1242-5	134 lbs	CL20G-87-1242-5	123 lbs	CL18G-99-1242-5	136 lbs	CL20G-99-1242-5	125 lbs
15" x 42"	CL18G-75-1542-5	125 lbs	CL20G-75-1542-5	106 lbs	CL18G-87-1542-5	146 lbs	CL20G-87-1542-5	127 lbs	CL18G-99-1542-5	148 lbs	CL20G-99-1542-5	129 lbs
18" x 42"	CL18G-75-1842-5	138 lbs	CL20G-75-1842-5	117 lbs	CL18G-87-1842-5	161 lbs	CL20G-87-1842-5	139 lbs	CL18G-99-1842-5	163 lbs	CL20G-99-1842-5	141 lbs
24" x 42"	CL18G-75-2442-5	167 lbs	CL20G-75-2442-5	137 lbs	CL18G-87-2442-5	192 lbs	CL20G-87-2442-5	162 lbs	CL18G-99-2442-5	194 lbs	CL20G-99-2442-5	164 lbs
30" x 42"	CL18G-75-3042-5	191 lbs	CL20G-75-3042-5	153 lbs	CL18G-87-3042-5	220 lbs	CL20G-87-3042-5	183 lbs	CL18G-99-3042-5	222 lbs	CL20G-99-3042-5	184 lbs
12" x 48"	CL18G-75-1248-5	129 lbs	CL20G-75-1248-5	116 lbs	CL18G-87-1248-5	153 lbs	CL20G-87-1248-5	140 lbs	CL18G-99-1248-5	155 lbs	CL20G-99-1248-5	142 lbs
15" x 48"	CL18G-75-1548-5	141 lbs	CL20G-75-1548-5	121 lbs	CL18G-87-1548-5	165 lbs	CL20G-87-1548-5	144 lbs	CL18G-99-1548-5	167 lbs	CL20G-99-1548-5	147 lbs
18" x 48"	CL18G-75-1848-5	152 lbs	CL20G-75-1848-5	128 lbs	CL18G-87-1848-5	178 lbs	CL20G-87-1848-5	154 lbs	CL18G-99-1848-5	180 lbs	CL20G-99-1848-5	156 lbs
24" x 48"	CL18G-75-2448-5	184 lbs	CL20G-75-2448-5	153 lbs	CL18G-87-2448-5	213 lbs	CL20G-87-2448-5	181 lbs	CL18G-99-2448-5	215 lbs	CL20G-99-2448-5	183 lbs
30" x 48"	CL18G-75-3048-5	209 lbs	CL20G-75-3048-5	175 lbs	CL18G-87-3048-5	240 lbs	CL20G-87-3048-5	205 lbs	CL18G-99-3048-5	242 lbs	CL20G-99-3048-5	207 lbs
6 Shelf, 75"H Open Shelving Unit												
12" x 36"	CL18G-75-1236-6	106 lbs	CL20G-75-1236-6	97 lbs	CL18G-87-1236-6	124 lbs	CL20G-87-1236-6	115 lbs	CL18G-99-1236-6	126 lbs	CL20G-99-1236-6	117 lbs
15" x 36"	CL18G-75-1536-6	123 lbs	CL20G-75-1536-6	103 lbs	CL18G-87-1536-6	142 lbs	CL20G-87-1536-6	122 lbs	CL18G-99-1536-6	144 lbs	CL20G-99-1536-6	124 lbs
18" x 36"	CL18G-75-1836-6	138 lbs	CL20G-75-1836-6	114 lbs	CL18G-87-1836-6	161 lbs	CL20G-87-1836-6	137 lbs	CL18G-99-1836-6	163 lbs	CL20G-99-1836-6	139 lbs
24" x 36"	CL18G-75-2436-6	166 lbs	CL20G-75-2436-6	138 lbs	CL18G-87-2436-6	190 lbs	CL20G-87-2436-6	162 lbs	CL18G-99-2436-6	192 lbs	CL20G-99-2436-6	164 lbs
30" x 36"	CL18G-75-3036-6	189 lbs	CL20G-75-3036-6	157 lbs	CL18G-87-3036-6	215 lbs	CL20G-87-3036-6	183 lbs	CL18G-99-3036-6	217 lbs	CL20G-99-3036-6	185 lbs
12" x 42"	CL18G-75-1242-6	125 lbs	CL20G-75-1242-6	111 lbs	CL18G-87-1242-6	145 lbs	CL20G-87-1242-6	131 lbs	CL18G-99-1242-6	147 lbs	CL20G-99-1242-6	133 lbs
15" x 42"	CL18G-75-1542-6	137 lbs	CL20G-75-1542-6	115 lbs	CL18G-87-1542-6	158 lbs	CL20G-87-1542-6	135 lbs	CL18G-99-1542-6	160 lbs	CL20G-99-1542-6	137 lbs
18" x 42"	CL18G-75-1842-6	151 lbs	CL20G-75-1842-6	125 lbs	CL18G-87-1842-6	175 lbs	CL20G-87-1842-6	149 lbs	CL18G-99-1842-6	177 lbs	CL20G-99-1842-6	151 lbs
24" x 42"	CL18G-75-2442-6	185 lbs	CL20G-75-2442-6	149 lbs	CL18G-87-2442-6	211 lbs	CL20G-87-2442-6	175 lbs	CL18G-99-2442-6	213 lbs	CL20G-99-2442-6	177 lbs
30" x 42"	CL18G-75-3042-6	213 lbs	CL20G-75-3042-6	167 lbs	CL18G-87-3042-6	242 lbs	CL20G-87-3042-6	196 lbs	CL18G-99-3042-6	244 lbs	CL20G-99-3042-6	198 lbs
12" x 48"	CL18G-75-1248-6	141 lbs	CL20G-75-1248-6	125 lbs	CL18G-87-1248-6	165 lbs	CL20G-87-1248-6	149 lbs	CL18G-99-1248-6	167 lbs	CL20G-99-1248-6	151 lbs
15" x 48"	CL18G-75-1548-6	154 lbs	CL20G-75-1548-6	130 lbs	CL18G-87-1548-6	179 lbs	CL20G-87-1548-6	155 lbs	CL18G-99-1548-6	181 lbs	CL20G-99-1548-6	157 lbs
18" x 48"	CL18G-75-1848-6	168 lbs	CL20G-75-1848-6	140 lbs	CL18G-87-1848-6	194 lbs	CL20G-87-1848-6	165 lbs	CL18G-99-1848-6	196 lbs	CL20G-99-1848-6	167 lbs
24" x 48"	CL18G-75-2448-6	205 lbs	CL20G-75-2448-6	167 lbs	CL18G-87-2448-6	233 lbs	CL20G-87-2448-6	196 lbs	CL18G-99-2448-6	235 lbs	CL20G-99-2448-6	198 lbs
30" x 48"	CL18G-75-3048-6	234 lbs	CL20G-75-3048-6	192 lbs	CL18G-87-3048-6	265 lbs	CL20G-87-3048-6	223 lbs	CL18G-99-3048-6	267 lbs	CL20G-99-3048-6	225 lbs
7 Shelf, 75"H Open Shelving Unit												
12" x 36"	CL18G-75-1236-7	115 lbs	CL20G-75-1236-7	104 lbs	CL18G-87-1236-7	132 lbs	CL20G-87-1236-7	122 lbs	CL18G-99-1236-7	134 lbs	CL20G-99-1236-7	124 lbs
15" x 36"	CL18G-75-1536-7	134 lbs	CL20G-75-1536-7	110 lbs	CL18G-87-1536-7	153 lbs	CL20G-87-1536-7	129 lbs	CL18G-99-1536-7	155 lbs	CL20G-99-1536-7	131 lbs
18" x 36"	CL18G-75-1836-7	151 lbs	CL20G-75-1836-7	124 lbs	CL18G-87-1836-7	173 lbs	CL20G-87-1836-7	146 lbs	CL18G-99-1836-7	175 lbs	CL20G-99-1836-7	148 lbs
24" x 36"	CL18G-75-2436-7	182 lbs	CL20G-75-2436-7	151 lbs	CL18G-87-2436-7	206 lbs	CL20G-87-2436-7	173 lbs	CL18G-99-2436-7	207 lbs	CL20G-99-2436-7	175 lbs
30" x 36"	CL18G-75-3036-7	208 lbs	CL20G-75-3036-7	171 lbs	CL18G-87-3036-7	234 lbs	CL20G-87-3036-7	197 lbs	CL18G-99-3036-7	236 lbs	CL20G-99-3036-7	199 lbs
12" x 42"	CL18G-75-1242-7	136 lbs	CL20G-75-1242-7	120 lbs	CL18G-87-1242-7	156 lbs	CL20G-87-1242-7	140 lbs	CL18G-99-1242-7	158 lbs	CL20G-99-1242-7	142 lbs
15" x 42"	CL18G-75-1542-7	150 lbs	CL20G-75-1542-7	123 lbs	CL18G-87-1542-7	171 lbs	CL20G-87-1542-7	144 lbs	CL18G-99-1542-7	173 lbs	CL20G-99-1542-7	146 lbs
18" x 42"	CL18G-75-1842-7	166 lbs	CL20G-75-1842-7	136 lbs	CL18G-87-1842-7	189 lbs	CL20G-87-1842-7	159 lbs	CL18G-99-1842-7	191 lbs	CL20G-99-1842-7	161 lbs
24" x 42"	CL18G-75-2442-7	203 lbs	CL20G-75-2442-7	161 lbs	CL18G-87-2442-7	229 lbs	CL20G-87-2442-7	187 lbs	CL18G-99-2442-7	231 lbs	CL20G-99-2442-7	189 lbs
30" x 42"	CL18G-75-3042-7	235 lbs	CL20G-75-3042-7	182 lbs	CL18G-87-3042-7	264 lbs	CL20G-87-3042-7	211 lbs	CL18G-99-3042-7	266 lbs	CL20G-99-3042-7	213 lbs
12" x 48"	CL18G-75-1248-7	153 lbs	CL20G-75-1248-7	135 lbs	CL18G-87-1248-7	177 lbs	CL20G-87-1248-7	159 lbs	CL18G-99-1248-7	179 lbs	CL20G-99-1248-7	163 lbs
15" x 48"	CL18G-75-1548-7	168 lbs	CL20G-75-1548-7	140 lbs	CL18G-87-1548-7	193 lbs	CL20G-87-1548-7	165 lbs	CL18G-99-1548-7	195 lbs	CL20G-99-1548-7	167 lbs
18" x 48"	CL18G-75-1848-7	184 lbs	CL20G-75-1848-7	151 lbs	CL18G-87-1848-7	210 lbs	CL20G-87-1848-7	177 lbs	CL18G-99-1848-7	212 lbs	CL20G-99-1848-7	179 lbs
24" x 48"	CL18G-75-2448-7	225 lbs	CL20G-75-2448-7	181 lbs	CL18G-87-2448-7	254 lbs	CL20G-87-2448-7	210 lbs	CL18G-99-2448-7	256 lbs	CL20G-99-2448-7	212 lbs
30" x 48"	CL18G-75-3048-7	259 lbs	CL20G-75-3048-7	210 lbs	CL18G-87-3048-7	289 lbs	CL20G-87-3048-7	241 lbs	CL18G-99-3048-7	291 lbs	CL20G-99-3048-7	243 lbs

IRONMAN - Gauge Steel Closed Clip Shelving - Add-On Kits

Quantum's IRONMAN Closed Shelving Units are ideal for industrial and commercial storage and organization. Closed shelving provides extra protection from dirt & dust, creates separation between areas and prevents product from falling off sides or back of unit. Units are available in 18 & 20 gauge, 4 heights and 15 shelf sizes. Each add-on unit includes 2 offset posts (punched on 1" centers for easy adjustment), one beaded post, one back panel, one side panel and selected number of shelves with corresponding hardware (nuts and bolts for top and bottom shelves, clips for intermediate shelves). See shelf chart on pg. 94 for load weight capacity. Easy and quick assembly. Available in Gray.

CLIP SHELVES MAKE FOR EASY BOLT-FREE ASSEMBLY AND ADJUSTMENT



20G-75-1836-5 + AD20G-75-1836-5

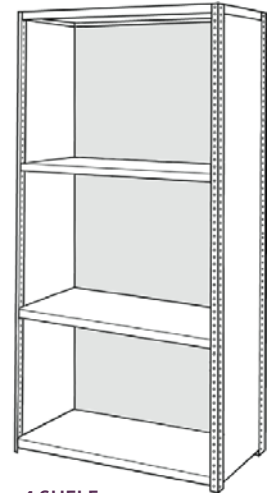

4 SHELF ADD-ON KITS

SHELF D" x W"	39"H			
	18 GAUGE		20 GAUGE	
MODEL NO.	SHIP WGT	MODEL NO.	SHIP WGT	
4 Shelf, 39"H Closed Shelving Unit				
12" x 36"	ADCL18G-39-1236-4 52 lbs	ADCL20G-39-1236-4 47 lbs		
15" x 36"	ADCL18G-39-1536-4 64 lbs	ADCL20G-39-1536-4 51 lbs		
18" x 36"	ADCL18G-39-1836-4 71 lbs	ADCL20G-39-1836-4 56 lbs		
24" x 36"	ADCL18G-39-2436-4 87 lbs	ADCL20G-39-2436-4 69 lbs		
30" x 36"	ADCL18G-39-3036-4 102 lbs	ADCL20G-39-3036-4 80 lbs		
12" x 42"	ADCL18G-39-1242-4 63 lbs	ADCL20G-39-1242-4 55 lbs		
15" x 42"	ADCL18G-39-1542-4 68 lbs	ADCL20G-39-1542-4 59 lbs		
18" x 42"	ADCL18G-39-1842-4 82 lbs	ADCL20G-39-1842-4 63 lbs		
24" x 42"	ADCL18G-39-2442-4 99 lbs	ADCL20G-39-2442-4 75 lbs		
30" x 42"	ADCL18G-39-3042-4 115 lbs	ADCL20G-39-3042-4 85 lbs		
12" x 48"	ADCL18G-39-1248-4 71 lbs	ADCL20G-39-1248-4 59 lbs		
15" x 48"	ADCL18G-39-1548-4 80 lbs	ADCL20G-39-1548-4 63 lbs		
18" x 48"	ADCL18G-39-1848-4 89 lbs	ADCL20G-39-1848-4 71 lbs		
24" x 48"	ADCL18G-39-2448-4 109 lbs	ADCL20G-39-2448-4 84 lbs		
30" x 48"	ADCL18G-39-3048-4 127 lbs	ADCL20G-39-3048-4 99 lbs		
5 Shelf, 39"H Closed Shelving Unit				
12" x 36"	ADCL18G-39-1236-5 60 lbs	ADCL20G-39-1236-5 54 lbs		
15" x 36"	ADCL18G-39-1536-5 75 lbs	ADCL20G-39-1536-5 58 lbs		
18" x 36"	ADCL18G-39-1836-5 84 lbs	ADCL20G-39-1836-5 64 lbs		
24" x 36"	ADCL18G-39-2436-5 103 lbs	ADCL20G-39-2436-5 80 lbs		
30" x 36"	ADCL18G-39-3036-5 121 lbs	ADCL20G-39-3036-5 94 lbs		
12" x 42"	ADCL18G-39-1242-5 73 lbs	ADCL20G-39-1242-5 63 lbs		
15" x 42"	ADCL18G-39-1542-5 68 lbs	ADCL20G-39-1542-5 67 lbs		
18" x 42"	ADCL18G-39-1842-5 96 lbs	ADCL20G-39-1842-5 73 lbs		
24" x 42"	ADCL18G-39-2442-5 117 lbs	ADCL20G-39-2442-5 86 lbs		
30" x 42"	ADCL18G-39-3042-5 137 lbs	ADCL20G-39-3042-5 99 lbs		
12" x 48"	ADCL18G-39-1248-5 83 lbs	ADCL20G-39-1248-5 68 lbs		
15" x 48"	ADCL18G-39-1548-5 94 lbs	ADCL20G-39-1548-5 73 lbs		
18" x 48"	ADCL18G-39-1848-5 105 lbs	ADCL20G-39-1848-5 82 lbs		
24" x 48"	ADCL18G-39-2448-5 129 lbs	ADCL20G-39-2448-5 98 lbs		
30" x 48"	ADCL18G-39-3048-5 152 lbs	ADCL20G-39-3048-5 117 lbs		
6 Shelf, 39"H Closed Shelving Unit				
12" x 36"	ADCL18G-39-1236-6 68 lbs	ADCL20G-39-1236-6 61 lbs		
15" x 36"	ADCL18G-39-1536-6 86 lbs	ADCL20G-39-1536-6 65 lbs		
18" x 36"	ADCL18G-39-1836-6 96 lbs	ADCL20G-39-1836-6 72 lbs		
24" x 36"	ADCL18G-39-2436-6 119 lbs	ADCL20G-39-2436-6 91 lbs		
30" x 36"	ADCL18G-39-3036-6 140 lbs	ADCL20G-39-3036-6 108 lbs		
12" x 42"	ADCL18G-39-1242-6 83 lbs	ADCL20G-39-1242-6 71 lbs		
15" x 42"	ADCL18G-39-1542-6 88 lbs	ADCL20G-39-1542-6 75 lbs		
18" x 42"	ADCL18G-39-1842-6 110 lbs	ADCL20G-39-1842-6 73 lbs		
24" x 42"	ADCL18G-39-2442-6 135 lbs	ADCL20G-39-2442-6 97 lbs		
30" x 42"	ADCL18G-39-3042-6 159 lbs	ADCL20G-39-3042-6 113 lbs		
12" x 48"	ADCL18G-39-1248-6 95 lbs	ADCL20G-39-1248-6 77 lbs		
15" x 48"	ADCL18G-39-1548-6 108 lbs	ADCL20G-39-1548-6 73 lbs		
18" x 48"	ADCL18G-39-1848-6 121 lbs	ADCL20G-39-1848-6 93 lbs		
24" x 48"	ADCL18G-39-2448-6 149 lbs	ADCL20G-39-2448-6 112 lbs		
30" x 48"	ADCL18G-39-3048-6 177 lbs	ADCL20G-39-3048-6 134 lbs		

IRONMAN - Shelf Clips

Compression clip hardware can be used with our offset and beaded posts in combination with our steel shelves. Clips should be used for intermediate shelves only. Sold in packages of 4. (Note: One package required per shelf)



MODEL NO.	SHIP WGT
OP-CC	1 lb

PERFORMANCE FEATURES:

- High visibility allows for easy stocking and retrieval
- Intermediate clip shelves make for easy bolt-free assembly and adjustment
- Shelves are adjustable on 1" increments
- Sway braces on side and back provide stability

Additional Shelves and Clips available, see **pgs. 94 & 100**.
22 Gauge Shelving also available in three different sizes, see **pg. 102**.

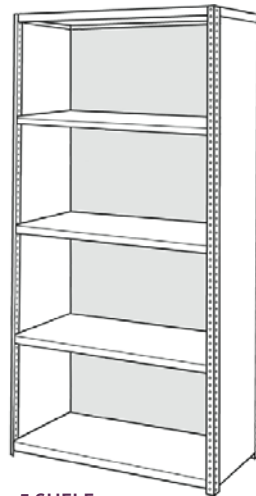

**5 SHELF
ADD-ON KITS**

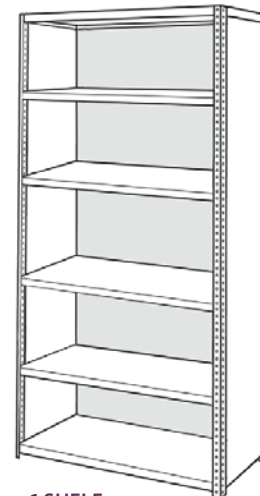

**6 SHELF
ADD-ON KITS**

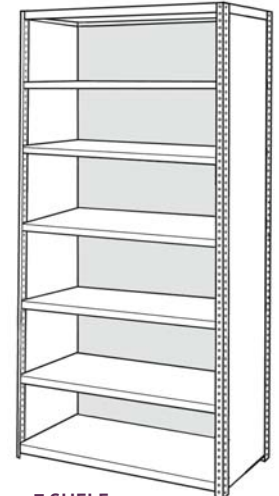

**7 SHELF
ADD-ON KITS**

SHELF D" x W"	75"H				87"H				99"H			
	18 GAUGE		20 GAUGE		18 GAUGE		20 GAUGE		18 GAUGE		20 GAUGE	
	MODEL NO.	SHIP WGT	MODEL NO.	SHIP WGT	MODEL NO.	SHIP WGT	MODEL NO.	SHIP WGT	MODEL NO.	SHIP WGT	MODEL NO.	SHIP WGT
5 Shelf, 75"H Closed Shelving Unit												
12" x 36"	ADCL18G-75-1236-5	98 lbs	ADCL20G-75-1236-5	90 lbs	ADCL18G-87-1236-5	116 lbs	ADCL20G-87-1236-5	108 lbs	ADCL18G-99-1236-5	118 lbs	ADCL20G-99-1236-5	110 lbs
15" x 36"	ADCL18G-75-1536-5	112 lbs	ADCL20G-75-1536-5	95 lbs	ADCL18G-87-1536-5	131 lbs	ADCL20G-87-1536-5	114 lbs	ADCL18G-99-1536-5	133 lbs	ADCL20G-99-1536-5	116 lbs
18" x 36"	ADCL18G-75-1836-5	126 lbs	ADCL20G-75-1836-5	107 lbs	ADCL18G-87-1836-5	148 lbs	ADCL20G-87-1836-5	129 lbs	ADCL18G-99-1836-5	150 lbs	ADCL20G-99-1836-5	131 lbs
24" x 36"	ADCL18G-75-2436-5	150 lbs	ADCL20G-75-2436-5	127 lbs	ADCL18G-87-2436-5	174 lbs	ADCL20G-87-2436-5	151 lbs	ADCL18G-99-2436-5	176 lbs	ADCL20G-99-2436-5	153 lbs
30" x 36"	ADCL18G-75-3036-5	170 lbs	ADCL20G-75-3036-5	143 lbs	ADCL18G-87-3036-5	196 lbs	ADCL20G-87-3036-5	169 lbs	ADCL18G-99-3036-5	198 lbs	ADCL20G-99-3036-5	171 lbs
12" x 42"	ADCL18G-75-1242-5	114 lbs	ADCL20G-75-1242-5	102 lbs	ADCL18G-87-1242-5	134 lbs	ADCL20G-87-1242-5	123 lbs	ADCL18G-99-1242-5	136 lbs	ADCL20G-99-1242-5	125 lbs
15" x 42"	ADCL18G-75-1542-5	125 lbs	ADCL20G-75-1542-5	106 lbs	ADCL18G-87-1542-5	146 lbs	ADCL20G-87-1542-5	127 lbs	ADCL18G-99-1542-5	148 lbs	ADCL20G-99-1542-5	129 lbs
18" x 42"	ADCL18G-75-1842-5	138 lbs	ADCL20G-75-1842-5	117 lbs	ADCL18G-87-1842-5	161 lbs	ADCL20G-87-1842-5	139 lbs	ADCL18G-99-1842-5	163 lbs	ADCL20G-99-1842-5	141 lbs
24" x 42"	ADCL18G-75-2442-5	167 lbs	ADCL20G-75-2442-5	137 lbs	ADCL18G-87-2442-5	192 lbs	ADCL20G-87-2442-5	162 lbs	ADCL18G-99-2442-5	194 lbs	ADCL20G-99-2442-5	164 lbs
30" x 42"	ADCL18G-75-3042-5	191 lbs	ADCL20G-75-3042-5	153 lbs	ADCL18G-87-3042-5	220 lbs	ADCL20G-87-3042-5	183 lbs	ADCL18G-99-3042-5	222 lbs	ADCL20G-99-3042-5	184 lbs
12" x 48"	ADCL18G-75-1248-5	129 lbs	ADCL20G-75-1248-5	116 lbs	ADCL18G-87-1248-5	153 lbs	ADCL20G-87-1248-5	140 lbs	ADCL18G-99-1248-5	155 lbs	ADCL20G-99-1248-5	142 lbs
15" x 48"	ADCL18G-75-1548-5	141 lbs	ADCL20G-75-1548-5	121 lbs	ADCL18G-87-1548-5	165 lbs	ADCL20G-87-1548-5	144 lbs	ADCL18G-99-1548-5	167 lbs	ADCL20G-99-1548-5	147 lbs
18" x 48"	ADCL18G-75-1848-5	152 lbs	ADCL20G-75-1848-5	128 lbs	ADCL18G-87-1848-5	178 lbs	ADCL20G-87-1848-5	154 lbs	ADCL18G-99-1848-5	180 lbs	ADCL20G-99-1848-5	156 lbs
24" x 48"	ADCL18G-75-2448-5	184 lbs	ADCL20G-75-2448-5	153 lbs	ADCL18G-87-2448-5	213 lbs	ADCL20G-87-2448-5	181 lbs	ADCL18G-99-2448-5	215 lbs	ADCL20G-99-2448-5	183 lbs
30" x 48"	ADCL18G-75-3048-5	209 lbs	ADCL20G-75-3048-5	175 lbs	ADCL18G-87-3048-5	240 lbs	ADCL20G-87-3048-5	205 lbs	ADCL18G-99-3048-5	242 lbs	ADCL20G-99-3048-5	207 lbs
6 Shelf, 75"H Closed Shelving Unit												
12" x 36"	ADCL18G-75-1236-6	106 lbs	ADCL20G-75-1236-6	97 lbs	ADCL18G-87-1236-6	124 lbs	ADCL20G-87-1236-6	115 lbs	ADCL18G-99-1236-6	126 lbs	ADCL20G-99-1236-6	117 lbs
15" x 36"	ADCL18G-75-1536-6	123 lbs	ADCL20G-75-1536-6	103 lbs	ADCL18G-87-1536-6	142 lbs	ADCL20G-87-1536-6	122 lbs	ADCL18G-99-1536-6	144 lbs	ADCL20G-99-1536-6	124 lbs
18" x 36"	ADCL18G-75-1836-6	138 lbs	ADCL20G-75-1836-6	114 lbs	ADCL18G-87-1836-6	161 lbs	ADCL20G-87-1836-6	137 lbs	ADCL18G-99-1836-6	163 lbs	ADCL20G-99-1836-6	139 lbs
24" x 36"	ADCL18G-75-2436-6	166 lbs	ADCL20G-75-2436-6	138 lbs	ADCL18G-87-2436-6	190 lbs	ADCL20G-87-2436-6	162 lbs	ADCL18G-99-2436-6	192 lbs	ADCL20G-99-2436-6	164 lbs
30" x 36"	ADCL18G-75-3036-6	189 lbs	ADCL20G-75-3036-6	157 lbs	ADCL18G-87-3036-6	215 lbs	ADCL20G-87-3036-6	183 lbs	ADCL18G-99-3036-6	217 lbs	ADCL20G-99-3036-6	185 lbs
12" x 42"	ADCL18G-75-1242-6	125 lbs	ADCL20G-75-1242-6	111 lbs	ADCL18G-87-1242-6	145 lbs	ADCL20G-87-1242-6	131 lbs	ADCL18G-99-1242-6	147 lbs	ADCL20G-99-1242-6	133 lbs
15" x 42"	ADCL18G-75-1542-6	137 lbs	ADCL20G-75-1542-6	115 lbs	ADCL18G-87-1542-6	158 lbs	ADCL20G-87-1542-6	135 lbs	ADCL18G-99-1542-6	160 lbs	ADCL20G-99-1542-6	137 lbs
18" x 42"	ADCL18G-75-1842-6	151 lbs	ADCL20G-75-1842-6	125 lbs	ADCL18G-87-1842-6	175 lbs	ADCL20G-87-1842-6	149 lbs	ADCL18G-99-1842-6	177 lbs	ADCL20G-99-1842-6	151 lbs
24" x 42"	ADCL18G-75-2442-6	185 lbs	ADCL20G-75-2442-6	149 lbs	ADCL18G-87-2442-6	211 lbs	ADCL20G-87-2442-6	175 lbs	ADCL18G-99-2442-6	213 lbs	ADCL20G-99-2442-6	177 lbs
30" x 42"	ADCL18G-75-3042-6	213 lbs	ADCL20G-75-3042-6	167 lbs	ADCL18G-87-3042-6	242 lbs	ADCL20G-87-3042-6	196 lbs	ADCL18G-99-3042-6	244 lbs	ADCL20G-99-3042-6	198 lbs
12" x 48"	ADCL18G-75-1248-6	141 lbs	ADCL20G-75-1248-6	125 lbs	ADCL18G-87-1248-6	165 lbs	ADCL20G-87-1248-6	149 lbs	ADCL18G-99-1248-6	167 lbs	ADCL20G-99-1248-6	151 lbs
15" x 48"	ADCL18G-75-1548-6	154 lbs	ADCL20G-75-1548-6	130 lbs	ADCL18G-87-1548-6	179 lbs	ADCL20G-87-1548-6	155 lbs	ADCL18G-99-1548-6	181 lbs	ADCL20G-99-1548-6	157 lbs
18" x 48"	ADCL18G-75-1848-6	168 lbs	ADCL20G-75-1848-6	140 lbs	ADCL18G-87-1848-6	194 lbs	ADCL20G-87-1848-6	165 lbs	ADCL18G-99-1848-6	196 lbs	ADCL20G-99-1848-6	167 lbs
24" x 48"	ADCL18G-75-2448-6	205 lbs	ADCL20G-75-2448-6	167 lbs	ADCL18G-87-2448-6	233 lbs	ADCL20G-87-2448-6	196 lbs	ADCL18G-99-2448-6	235 lbs	ADCL20G-99-2448-6	198 lbs
30" x 48"	ADCL18G-75-3048-6	234 lbs	ADCL20G-75-3048-6	192 lbs	ADCL18G-87-3048-6	265 lbs	ADCL20G-87-3048-6	223 lbs	ADCL18G-99-3048-6	267 lbs	ADCL20G-99-3048-6	225 lbs
7 Shelf, 75"H Closed Shelving Unit												
12" x 36"	ADCL18G-75-1236-7	115 lbs	ADCL20G-75-1236-7	104 lbs	ADCL18G-87-1236-7	132 lbs	ADCL20G-87-1236-7	122 lbs	ADCL18G-99-1236-7	134 lbs	ADCL20G-99-1236-7	124 lbs
15" x 36"	ADCL18G-75-1536-7	134 lbs	ADCL20G-75-1536-7	110 lbs	ADCL18G-87-1536-7	153 lbs	ADCL20G-87-1536-7	129 lbs	ADCL18G-99-1536-7	155 lbs	ADCL20G-99-1536-7	131 lbs
18" x 36"	ADCL18G-75-1836-7	151 lbs	ADCL20G-75-1836-7	124 lbs	ADCL18G-87-1836-7	173 lbs	ADCL20G-87-1836-7	146 lbs	ADCL18G-99-1836-7	175 lbs	ADCL20G-99-1836-7	148 lbs
24" x 36"	ADCL18G-75-2436-7	182 lbs	ADCL20G-75-2436-7	151 lbs	ADCL18G-87-2436-7	206 lbs	ADCL20G-87-2436-7	173 lbs	ADCL18G-99-2436-7	207 lbs	ADCL20G-99-2436-7	175 lbs
30" x 36"	ADCL18G-75-3036-7	208 lbs	ADCL20G-75-3036-7	171 lbs	ADCL18G-87-3036-7	234 lbs	ADCL20G-87-3036-7	197 lbs	ADCL18G-99-3036-7	236 lbs	ADCL20G-99-3036-7	199 lbs
12" x 42"	ADCL18G-75-1242-7	136 lbs	ADCL20G-75-1242-7	120 lbs	ADCL18G-87-1242-7	156 lbs	ADCL20G-87-1242-7	140 lbs	ADCL18G-99-1242-7	158 lbs	ADCL20G-99-1242-7	142 lbs
15" x 42"	ADCL18G-75-1542-7	150 lbs	ADCL20G-75-1542-7	123 lbs	ADCL18G-87-1542-7	171 lbs	ADCL20G-87-1542-7	144 lbs	ADCL18G-99-1542-7	173 lbs	ADCL20G-99-1542-7	146 lbs
18" x 42"	ADCL18G-75-1842-7	166 lbs	ADCL20G-75-1842-7	136 lbs	ADCL18G-87-1842-7	189 lbs	ADCL20G-87-1842-7	159 lbs	ADCL18G-99-1842-7	191 lbs	ADCL20G-99-1842-7	161 lbs
24" x 42"	ADCL18G-75-2442-7	203 lbs	ADCL20G-75-2442-7	161 lbs	ADCL18G-87-2442-7	229 lbs	ADCL20G-87-2442-7	187 lbs	ADCL18G-99-2442-7	231 lbs	ADCL20G-99-2442-7	189 lbs
30" x 42"	ADCL18G-75-3042-7	235 lbs	ADCL20G-75-3042-7	182 lbs	ADCL18G-87-3042-7	264 lbs	ADCL20G-87-3042-7	211 lbs	ADCL18G-99-3042-7	266 lbs	ADCL20G-99-3042-7	213 lbs
12" x 48"	ADCL18G-75-1248-7	153 lbs	ADCL20G-75-1248-7	135 lbs	ADCL18G-87-1248-7	177 lbs	ADCL20G-87-1248-7	159 lbs	ADCL18G-99-1248-7	179 lbs	ADCL20G-99-1248-7	161 lbs
15" x 48"	ADCL18G-75-1548-7	168 lbs	ADCL20G-75-1548-7	140 lbs	ADCL18G-87-1548-7	193 lbs	ADCL20G-87-1548-7	165 lbs	ADCL18G-99-1548-7	195 lbs	ADCL20G-99-1548-7	167 lbs
18" x 48"	ADCL18G-75-1848-7	184 lbs	ADCL20G-75-1848-7	151 lbs	ADCL18G-87-1848-7	210 lbs	ADCL20G-87-1848-7	177 lbs	ADCL18G-99-1848-7	212 lbs	ADCL20G-99-1848-7	179 lbs
24" x 48"	ADCL18G-75-2448-7	225 lbs	ADCL20G-75-2448-7	181 lbs	ADCL18G-87-2448-7	254 lbs	ADCL20G-87-2448-7	210 lbs	ADCL18G-99-2448-7	256 lbs	ADCL20G-99-2448-7	212 lbs
30" x 48"	ADCL18G-75-3048-7	259 lbs	ADCL20G-75-3048-7	210 lbs	ADCL18G-87-3048-7	289 lbs	ADCL20G-87-3048-7	241 lbs	ADCL18G-99-3048-7	291 lbs	ADCL20G-99-3048-7	243 lbs



IRONMAN - Steel Shelving

PERFORMANCE FEATURES:

- Heavy-duty, high grade shelving units are easy to clean and will not rust or corrode
- Shelving Units are 39"H or 75"H and are available in three different shelf sizes
- Shelving has a smooth powder coat finish
- 400 lb. shelf capacity



39-1836-4



75-1836-6

CLOSED SHELVING
DUST FREE & SECURE
STORAGE



CL39-1836-4



CL75-1836-6

MODEL NO.	SHELF D" x W"	SHIP WGT
4 Shelf, 39"H Open Shelving Unit		
39-1236-4	12" x 36"	45 lbs
39-1836-4	18" x 36"	63 lbs
5 Shelf, 39"H Open Shelving Unit		
39-1236-5	12" x 36"	53 lbs
39-1836-5	18" x 36"	75 lbs
6 Shelf, 39"H Open Shelving Unit		
39-1236-6	12" x 36"	61 lbs
39-1836-6	18" x 36"	87 lbs
4 Shelf, 75"H Open Shelving Unit		
75-1236-4	12" x 36"	55 lbs
75-1836-4	18" x 36"	69 lbs
75-1842-4	18" x 42"	85 lbs
5 Shelf, 75"H Open Shelving Unit		
75-1236-5	12" x 36"	66 lbs
75-1836-5	18" x 36"	79 lbs
75-1842-5	18" x 42"	91 lbs
6 Shelf, 75"H Open Shelving Unit		
75-1236-6	12" x 36"	73 lbs
75-1836-6	18" x 36"	89 lbs
75-1842-6	18" x 42"	101 lbs
7 Shelf, 75"H Open Shelving Unit		
75-1236-7	12" x 36"	80 lbs
75-1836-7	18" x 36"	99 lbs
75-1842-7	18" x 42"	113 lbs
8 Shelf, 75"H Open Shelving Unit		
75-1236-8	12" x 36"	87 lbs
75-1836-8	18" x 36"	109 lbs
75-1842-8	18" x 42"	125 lbs



MODEL NO.	SHELF D" x W"	SHIP WGT
4 Shelf, 39"H Closed Shelving Unit		
CL39-1236-4	12" x 36"	71 lbs
CL39-1836-4	18" x 36"	94 lbs
5 Shelf, 39"H Closed Shelving Unit		
CL39-1236-5	12" x 36"	79 lbs
CL39-1836-5	18" x 36"	106 lbs
6 Shelf, 39"H Closed Shelving Unit		
CL39-1236-6	12" x 36"	87 lbs
CL39-1836-6	18" x 36"	118 lbs
4 Shelf, 75"H Closed Shelving Unit		
CL75-1236-4	12" x 36"	90 lbs
CL75-1836-4	18" x 36"	115 lbs
5 Shelf, 75"H Closed Shelving Unit		
CL75-1236-5	12" x 36"	103 lbs
CL75-1836-5	18" x 36"	126 lbs
6 Shelf, 75"H Closed Shelving Unit		
CL75-1236-6	12" x 36"	110 lbs
CL75-1836-6	18" x 36"	136 lbs
7 Shelf, 75"H Closed Shelving Unit		
CL75-1236-7	12" x 36"	117 lbs
CL75-1836-7	18" x 36"	146 lbs
8 Shelf, 75"H Closed Shelving Unit		
CL75-1236-8	12" x 36"	124 lbs
CL75-1836-8	18" x 36"	156 lbs



Wire Shelving Systems Finishes



4 FINISHES AVAILABLE

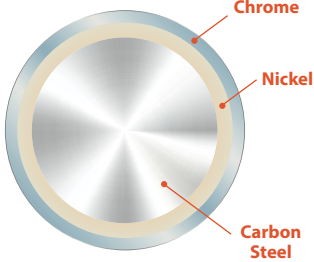

Chrome - is a plating process which deposits hard chrome over a cooper, nickel surface. This process is very durable and is used in storage or material handling applications in any dry storage environment. 1 year limited warranty to not rust or corrode when used in dry and non-humid environments.

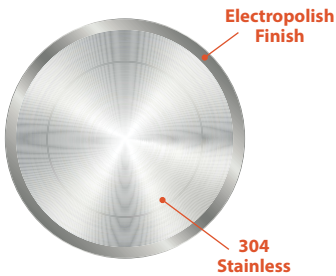
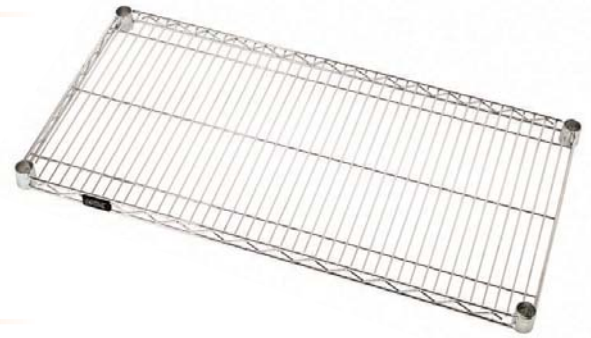

Stainless Steel - 304 Stainless with an electropolish finish represents the highest industry standard in the prevention of corrosion. This finish is highly effective for corrosive, high humidity or clean room environments. Lifetime warranty for 304 stainless steel electropolish finish.

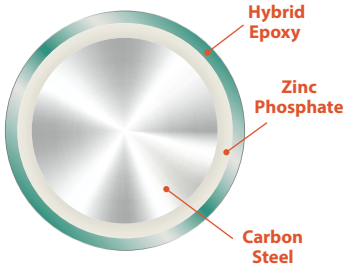
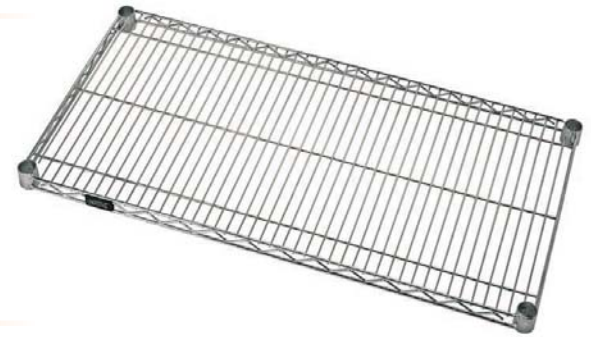

Proform - is an economical solution for high humidity or wet applications. The carbon steel is treated with a zinc phosphate base. A hybrid epoxy with an antibacterial agent is electrostatically applied over the treated surface. 15 year limited warranty for antimicrobial finish to not rust or corrode. **Color:** Light Green

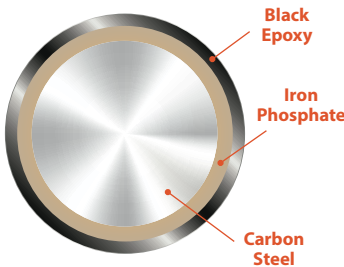
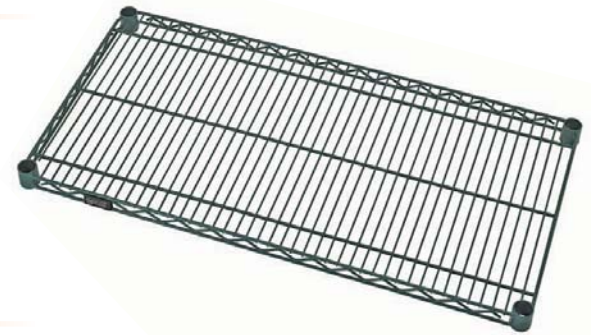

Black - treated with an iron phosphate and the powder coated black epoxy is electrostatically applied, baked and cured to a hard surface. 10 year limited warranty for finish to not rust or corrode.

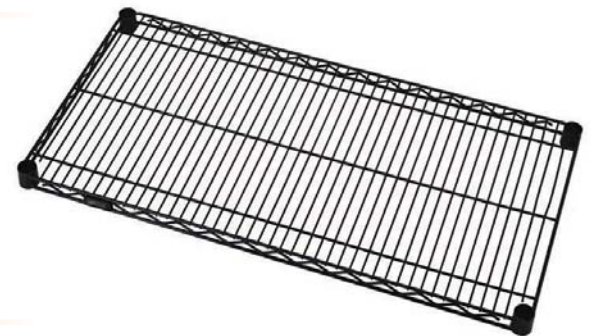

APPLICATION	CHROME FINISH	STAINLESS STEEL FINISH	PROFORM FINISH	BLACK FINISH
DRY STORAGE	YES	YES	YES	YES
WET STORAGE	NO	YES	YES	YES
COOLER STORAGE	NO	YES	YES	YES
FREEZER STORAGE	NO	YES	YES	YES
WARRANTY	*1 YEAR DRY	*LIFETIME	*15 YEAR	*10 YEAR

* Limited against rust and corrosion.

Wire Shelves



Genuine Quantum modular wire systems offer a unique combination of shelf and post sizes in a variety of finishes to compliment any application. The all welded shelf construction is supported with architectural wire trusses to provide between 600 lb. and 800 lb. capacity per shelf.

SHELF W" x L"	SHIP WGT	CHROME	STAINLESS STEEL	PROFORM	BLACK
		MODEL NO.	MODEL NO.	MODEL NO.	MODEL NO.
12" Deep Wire Shelves					
12" x 24"	6 lbs	1224C	1224S*	1224P*	1224BK*
12" x 30"	6 lbs	1230C	1230S*	1230P*	1230BK*
12" x 36"	7 lbs	1236C	1236S	1236P	1236BK
12" x 42"	8 lbs	1242C	1242S*	1242P*	1242BK*
12" x 48"	9 lbs	1248C	1248S	1248P	1248BK
12" x 60"	14 lbs	1260C	1260S	1260P	1260BK*
12" x 72"	17 lbs	1272C	1272S	1272P	1272BK*
14" Deep Wire Shelves					
14" x 24"	6 lbs	1424C	1424S*	1424P*	1424BK*
14" x 30"	7 lbs	1430C	1430S	1430P*	1430BK*
14" x 36"	8 lbs	1436C	1436S	1436P	1436BK*
14" x 42"	10 lbs	1442C	1442S	1442P*	1442BK*
14" x 48"	11 lbs	1448C	1448S	1448P	1448BK*
14" x 54"	12 lbs	1454C	1454S	1454P*	1454BK*
14" x 60"	14 lbs	1460C	1460S	1460P	1460BK*
14" x 72"	17 lbs	1472C	1472S	1472P	1472BK*
18" Deep Wire Shelves					
18" x 24"	7 lbs	1824C	1824S	1824P*	1824BK
18" x 30"	8 lbs	1830C	1830S	1830P	1830BK*
18" x 36"	10 lbs	1836C	1836S	1836P	1836BK
18" x 42"	11 lbs	1842C	1842S	1842P	1842BK*
18" x 48"	14 lbs	1848C	1848S	1848P	1848BK
18" x 54"	15 lbs	1854C	1854S	1854P	1854BK*
18" x 60"	17 lbs	1860C	1860S	1860P	1860BK
18" x 72"	20 lbs	1872C	1872S	1872P	1872BK
21" Deep Wire Shelves					
21" x 24"	8 lbs	2124C	2124S	2124P*	2124BK*
21" x 30"	9 lbs	2130C	2130S	2130P*	2130BK*
21" x 36"	11 lbs	2136C	2136S	2136P	2136BK*
21" x 42"	12 lbs	2142C	2142S	2142P*	2142BK*
21" x 48"	14 lbs	2148C	2148S	2148P	2148BK*
21" x 54"	16 lbs	2154C	2154S	2154P*	2154BK*
21" x 60"	18 lbs	2160C	2160S	2160P	2160BK*
21" x 72"	24 lbs	2172C	2172S	2172P	2172BK*
24" Deep Wire Shelves					
24" x 24"	9 lbs	2424C	2424S	2424P*	2424BK
24" x 30"	11 lbs	2430C	2430S	2430P	2430BK*
24" x 36"	13 lbs	2436C	2436S	2436P	2436BK
24" x 42"	15 lbs	2442C	2442S	2442P	2442BK*
24" x 48"	16 lbs	2448C	2448S	2448P	2448BK
24" x 54"	18 lbs	2454C	2454S	2454P	2454BK*
24" x 60"	21 lbs	2460C	2460S	2460P	2460BK
24" x 66"	23 lbs	2466C	2466S*	2466P	2466BK*
24" x 72"	26 lbs	2472C	2472S	2472P	2472BK
30" Deep Wire Shelves					
30" x 36"	15 lbs	3036C	3036S	3036P	3036BK*
30" x 42"	18 lbs	3042C	3042S	3042P	3042BK*
30" x 48"	21 lbs	3048C	3048S	3048P	3048BK*
30" x 60"	27 lbs	3060C	3060S	3060P	3060BK*
30" x 72"	31 lbs	3072C	3072S	3072P	3072BK*
36" Deep Wire Shelves					
36" x 36"	18 lbs	3636C	3636S	3636P	3636BK*
36" x 48"	23 lbs	3648C	3648S	3648P	3648BK*
36" x 60"	29 lbs	3660C	3660S	3660P	3660BK
36" x 72"	35 lbs	3672C	3672S	3672P	3672BK

* Special order. Minimum quantity and extended lead time may apply. Please call for details.



600 - 800 lb.
LOAD CAPACITY PER SHELF

PERFORMANCE FEATURES:

- All welded construction with additional wire trussing for high strength characteristics
- Top mat wires run front to back (except on 12" x 36" size) for ease of loading and unloading
- Wire allows air to circulate and light to penetrate for increased product visibility
- Minimal dirt accumulation
- Split conical sleeve adaptors secure shelf corner to post
- Numbered grooved posts on 1 inch increments for quick assembly
- No tools required for assembly
- Adjustable foot levelers
- Durable finishes
- Aesthetically pleasing
- Optional accessories
- National Sanitation Foundation (NSF) Approved
- Shipped KD Class 70
- 600 to 800 lb. capacity per shelf



Posts

All posts are fabricated from 16 gauge carbon steel with location grooves on one inch increments and ease for shelf installation. Numbers are printed between grooves for quick assembly. Posts are double grooved in consistent intervals for quick identification. Leveling legs are enclosed with all posts. Leveling legs cannot be used in conjunction with stem casters. See **pg. 153** to order caster sets. Custom post heights are available, call for pricing.

		CHROME	STAINLESS STEEL	PROFORM	BLACK
DESCRIPTION	SHIP WGT	MODEL NO.	MODEL NO.	MODEL NO.	MODEL NO.
6"H Post	1 lb	P6C	P6S	P6P	P6BK*
14"H Post	1 lb	P14C	P14S	P14P	P14BK*
34"H Post	2 lbs	P34C	P34S	P34P	P34BK
36"H Post	2 lbs	P36C	P36S*	P36P*	P36BK*
39"H Post	2 lbs	P39C	P39S*	P39P*	P39BK*
42"H Post	2 lbs	P42C*	P42S	P42P*	P42BK*
54"H Post	3 lbs	P54C	P54S	P54P	P54BK
63"H Post	4 lbs	P63C	P63S	P63P	P63BK
74"H Post	4 lbs	P74C	P74S	P74P	P74BK
86"H Post	5 lbs	P86C	P86S	P86P	P86BK
96"H Post	6 lbs	P96C	P96S	P96P	-

* Not a standard inventory size. To purchase, order next size up and apply cut charge to cut to this custom height.

Solid Shelves

- Designed for storage of small parts that might normally fall through wire shelves
- Dual layer construction with double hemmed perimeter with marine edge ensures maximum strength while retaining spillage and excellent corrosion resistance

		GALVANIZED STEEL	STAINLESS STEEL
DIMENSIONS W" x L"	SHIP WGT	MODEL NO.	MODEL NO.
14" Deep Solid Shelves			
14" x 36"	14 lbs	1436SG	1436SS
14" x 42"	15 lbs	1442SG	1442SS
14" x 48"	17 lbs	1448SG	1448SS
14" x 54"	20 lbs	1454SG	1454SS
14" x 60"	22 lbs	1460SG	1460SS
14" x 72"	26 lbs	1472SG	1472SS
18" Deep Solid Shelves			
18" x 24"	11 lbs	1824SG	1824SS
18" x 30"	14 lbs	1830SG	1830SS
18" x 36"	16 lbs	1836SG	1836SS
18" x 42"	18 lbs	1842SG	1842SS
18" x 48"	20 lbs	1848SG	1848SS
18" x 54"	22 lbs	1854SG	1854SS
18" x 60"	24 lbs	1860SG	1860SS
18" x 72"	27 lbs	1872SG	1872SS
21" Deep Solid Shelves			
21" x 24"	13 lbs	2124SG	2124SS
21" x 30"	15 lbs	2130SG	2130SS
21" x 36"	18 lbs	2136SG	2136SS
21" x 42"	21 lbs	2142SG	2142SS
21" x 48"	23 lbs	2148SG	2148SS
21" x 54"	25 lbs	2154SG	2154SS
21" x 60"	28 lbs	2160SG	2160SS
21" x 72"	30 lbs	2172SG	2172SS
24" Deep Solid Shelves			
24" x 24"	15 lbs	2424SG	2424SS
24" x 30"	17 lbs	2430SG	2430SS
24" x 36"	19 lbs	2436SG	2436SS
24" x 42"	22 lbs	2442SG	2442SS
24" x 48"	24 lbs	2448SG	2448SS
24" x 54"	26 lbs	2454SG	2454SS
24" x 60"	31 lbs	2460SG	2460SS
24" x 72"	34 lbs	2472SG	2472SS



18 GAUGE GALVANIZED OR 304 STAINLESS STEEL

ASSEMBLING WIRE SHELVING UNITS IS AS EASY AS 1 - 2 - 3...



1 Snap plastic sleeve around post.



2 Slide shelf over sleeve for secure locking.



3 Two "S-Hooks" are used to connect add-on wire shelf to starter units.

W-PC-STUD

Threaded Stud Connector can be utilized to connect two posts enabling any post height to be achieved. Must be used with **WR-WMB** See **pg. 152**



LASER PRINTED NUMBERS

For quick shelf positioning



W-PLI

Post Insert Additional pieces available, sold as 4-pack

W-PLB

Post Leveler adjusts up or down allowing height flexibility

Starter Kits



Heavy-duty shelving unit allows up to 800 lb. shelf capacity. Starter kits come complete with 4 posts and 4 or 5 shelves. Additional shelves may be purchased separately. See chart on **pg. 104**. Mobilize starter kit shelving unit using optional mobile kit, **WR-00H**, see **pg.153**. **Finishes:** Chrome, Stainless Steel, Proform and Black



MOBILIZE YOUR WIRE SHELVING

DB - Donut Bumper
Non-marking donut bumper used to protect walls and help cushion impact.

WR-00H (Mobile Kit)*
Set of four swivel polyurethane 5" x 1-1/4" casters, two with brakes. Can be used with all units shown. 1,200 lb. load capacity. *Mobile kits recommended only for shelves 18" and wider.

TO CHOOSE FINISH ADD FINISH SUFFIX TO MODEL NO.

Ex: **Chrome** WR54-1236C
Stainless WR54-1236S
Proform WR54-1236P
Black WR54-1236BK

Ex: **Chrome** WR54-1236C-5
Stainless WR54-1236S-5
Proform WR54-1236P-5
Black WR54-1236BK-5

Chrome
Stainless
Proform
BK Black

SHELF W" x L"	54"H WIRE SHELVING 4 SHELVES				54"H WIRE SHELVING 5 SHELVES				AVAILABLE FINISHES		
	STARTER KIT MODEL NO.	SHIP WGT	ADD-ON KIT MODEL NO.	SHIP WGT	STARTER KIT MODEL NO.	SHIP WGT	ADD-ON KIT MODEL NO.	SHIP WGT	C	S	P BK
12" x 36"	WR54-1236	40 lbs	AD54-1236	36 lbs	WR54-1236-5	47 lbs	AD54-1236-5	45 lbs	Y	Y	Y Y
12" x 42"	WR54-1242	44 lbs	AD54-1242	40 lbs	WR54-1242-5	52 lbs	AD54-1242-5	50 lbs	Y	N	N N
12" x 48"	WR54-1248	48 lbs	AD54-1248	44 lbs	WR54-1248-5	57 lbs	AD54-1248-5	55 lbs	Y	Y	Y Y
12" x 60"	WR54-1260	56 lbs	AD54-1260	52 lbs	WR54-1260-5	70 lbs	AD54-1260-5	68 lbs	Y	Y	Y N
12" x 72"	WR54-1272	64 lbs	AD54-1272	60 lbs	WR54-1272-5	81 lbs	AD54-1272-5	79 lbs	Y	Y	Y N
14" x 24"	WR54-1424	36 lbs	AD54-1424	32 lbs	WR54-1424-5	42 lbs	AD54-1424-5	40 lbs	Y	N	N N
14" x 30"	WR54-1430	40 lbs	AD54-1430	36 lbs	WR54-1430-5	47 lbs	AD54-1430-5	45 lbs	Y	Y	N N
14" x 36"	WR54-1436	44 lbs	AD54-1436	40 lbs	WR54-1436-5	52 lbs	AD54-1436-5	50 lbs	Y	Y	Y N
14" x 42"	WR54-1442	52 lbs	AD54-1442	48 lbs	WR54-1442-5	62 lbs	AD54-1442-5	60 lbs	Y	Y	N N
14" x 48"	WR54-1448	56 lbs	AD54-1448	52 lbs	WR54-1448-5	67 lbs	AD54-1448-5	65 lbs	Y	Y	Y N
14" x 54"	WR54-1454	60 lbs	AD54-1454	56 lbs	WR54-1454-5	72 lbs	AD54-1454-5	70 lbs	Y	Y	N N
14" x 60"	WR54-1460	68 lbs	AD54-1460	64 lbs	WR54-1460-5	82 lbs	AD54-1460-5	80 lbs	Y	Y	Y N
14" x 72"	WR54-1472	80 lbs	AD54-1472	76 lbs	WR54-1472-5	97 lbs	AD54-1472-5	95 lbs	Y	Y	Y N
18" x 24"	WR54-1824	40 lbs	AD54-1824	36 lbs	WR54-1824-5	47 lbs	AD54-1824-5	45 lbs	Y	Y	N Y
18" x 30"	WR54-1830	44 lbs	AD54-1830	40 lbs	WR54-1830-5	52 lbs	AD54-1830-5	50 lbs	Y	Y	Y N
18" x 36"	WR54-1836	52 lbs	AD54-1836	48 lbs	WR54-1836-5	62 lbs	AD54-1836-5	60 lbs	Y	Y	Y Y
18" x 42"	WR54-1842	56 lbs	AD54-1842	52 lbs	WR54-1842-5	67 lbs	AD54-1842-5	65 lbs	Y	Y	Y N
18" x 48"	WR54-1848	60 lbs	AD54-1848	56 lbs	WR54-1848-5	74 lbs	AD54-1848-5	72 lbs	Y	Y	Y Y
18" x 54"	WR54-1854	72 lbs	AD54-1854	68 lbs	WR54-1854-5	87 lbs	AD54-1854-5	81 lbs	Y	Y	Y N
18" x 60"	WR54-1860	80 lbs	AD54-1860	76 lbs	WR54-1860-5	97 lbs	AD54-1860-5	95 lbs	Y	Y	Y Y
18" x 72"	WR54-1872	92 lbs	AD54-1872	88 lbs	WR54-1872-5	112 lbs	AD54-1872-5	58 lbs	Y	Y	Y Y
21" x 24"	WR54-2124	44 lbs	AD54-2124	40 lbs	WR54-2124-5	52 lbs	AD54-2124-5	50 lbs	Y	Y	N N
21" x 30"	WR54-2130	48 lbs	AD54-2130	44 lbs	WR54-2130-5	57 lbs	AD54-2130-5	59 lbs	Y	Y	N N
21" x 36"	WR54-2136	56 lbs	AD54-2136	52 lbs	WR54-2136-5	67 lbs	AD54-2136-5	65 lbs	Y	Y	Y N
21" x 42"	WR54-2142	60 lbs	AD54-2142	56 lbs	WR54-2142-5	72 lbs	AD54-2142-5	70 lbs	Y	Y	N N
21" x 48"	WR54-2148	68 lbs	AD54-2148	64 lbs	WR54-2148-5	82 lbs	AD54-2148-5	84 lbs	Y	Y	Y N
21" x 54"	WR54-2154	76 lbs	AD54-2154	72 lbs	WR54-2154-5	92 lbs	AD54-2154-5	94 lbs	Y	Y	N N
21" x 60"	WR54-2160	84 lbs	AD54-2160	80 lbs	WR54-2160-5	102 lbs	AD54-2160-5	108 lbs	Y	Y	Y N
21" x 72"	WR54-2172	108 lbs	AD54-2172	104 lbs	WR54-2172-5	132 lbs	AD54-2172-5	130 lbs	Y	Y	Y N
24" x 24"	WR54-2424	48 lbs	AD54-2424	44 lbs	WR54-2424-5	57 lbs	AD54-2424-5	55 lbs	Y	Y	N Y
24" x 30"	WR54-2430	56 lbs	AD54-2430	52 lbs	WR54-2430-5	67 lbs	AD54-2430-5	65 lbs	Y	Y	Y N
24" x 36"	WR54-2436	64 lbs	AD54-2436	60 lbs	WR54-2436-5	77 lbs	AD54-2436-5	75 lbs	Y	Y	Y Y
24" x 42"	WR54-2442	72 lbs	AD54-2442	68 lbs	WR54-2442-5	87 lbs	AD54-2442-5	85 lbs	Y	Y	Y N
24" x 48"	WR54-2448	76 lbs	AD54-2448	72 lbs	WR54-2448-5	92 lbs	AD54-2448-5	90 lbs	Y	Y	Y Y
24" x 54"	WR54-2454	84 lbs	AD54-2454	80 lbs	WR54-2454-5	102 lbs	AD54-2454-5	100 lbs	Y	Y	Y N
24" x 60"	WR54-2460	96 lbs	AD54-2460	92 lbs	WR54-2460-5	117 lbs	AD54-2460-5	115 lbs	Y	Y	Y Y
24" x 72"	WR54-2472	116 lbs	AD54-2472	112 lbs	WR54-2472-5	142 lbs	AD54-2472-5	142 lbs	Y	Y	Y Y
30" x 36"	WR54-3036	72 lbs	AD54-3036	68 lbs	WR54-3036-5	87 lbs	AD54-3036-5	85 lbs	Y	Y	Y N
30" x 42"	WR54-3042	84 lbs	AD54-3042	80 lbs	WR54-3042-5	102 lbs	AD54-3042-5	100 lbs	Y	Y	Y N
30" x 48"	WR54-3048	96 lbs	AD54-3048	92 lbs	WR54-3048-5	117 lbs	AD54-3048-5	115 lbs	Y	Y	Y N
30" x 60"	WR54-3060	120 lbs	AD54-3060	116 lbs	WR54-3060-5	147 lbs	AD54-3060-5	145 lbs	Y	Y	Y N
30" x 72"	WR54-3072	136 lbs	AD54-3072	132 lbs	WR54-3072-5	167 lbs	AD54-3072-5	165 lbs	Y	Y	Y Y
36" x 36"	WR54-3636	84 lbs	AD54-3636	80 lbs	WR54-3636-5	102 lbs	AD54-3636-5	100 lbs	Y	Y	Y N
36" x 48"	WR54-3648	104 lbs	AD54-3648	100 lbs	WR54-3648-5	127 lbs	AD54-3648-5	125 lbs	Y	Y	Y N
36" x 60"	WR54-3660	128 lbs	AD54-3660	124 lbs	WR54-3660-5	157 lbs	AD54-3660-5	155 lbs	Y	Y	Y Y
36" x 72"	WR54-3672	136 lbs	AD54-3672	132 lbs	WR54-3672-5	171 lbs	AD54-3672-5	169 lbs	Y	Y	Y Y

Shelving units include 4 posts and 4 or 5 shelves. Add-On units include 2 posts, 4 or 5 shelves and 8 or 10 S-Hooks.

Y (Yes) N (No)



4 SHELF STARTER KITS
Stainless Steel Finish



5 SHELF STARTER KITS
Chrome Finish



LOWEST PRICE GUARANTEED!

Add-On Kits

Additional Add-On kit allows you to expand your Starter kit by sharing a set of posts. Configuration options include straight line, back to back and right angles (L-Shape). Add-On kits come complete with 2 posts, 4 or 5 shelves and 8 or 10 S-Hooks. Additional shelves and posts may be purchased separately. See chart on pg.104. Units with Add-On kit cannot be made mobile. **Finishes:** Chrome, Stainless Steel, Proform and Black

600 - 800 lb.
LOAD CAPACITY
PER SHELF

TO CHOOSE FINISH ADD FINISH SUFFIX TO MODEL NO.

Ex: **Chrome** WR63-1236C
Stainless WR63-1236S
Proform WR63-1236P
Black WR63-1236BK

Ex: **Chrome** WR63-1236C-5
Stainless WR63-1236S-5
Proform WR63-1236P-5
Black WR63-1236BK-5

Chrome
Stainless
Proform
BK Black

SHELF W" x L"	63"H WIRE SHELVING 4 SHELVES				63"H WIRE SHELVING 5 SHELVES				AVAILABLE FINISHES			
	STARTER KIT MODEL NO.	SHIP WGT	ADD-ON KIT MODEL NO.	SHIP WGT	STARTER KIT MODEL NO.	SHIP WGT	ADD-ON KIT MODEL NO.	SHIP WGT	C	S	P	BK
12" x 36"	WR63-1236	42 lbs	AD63-1236	37 lbs	WR63-1236-5	49 lbs	AD63-1236-5	46 lbs	Y	Y	Y	Y
12" x 42"	WR63-1242	46 lbs	AD63-1242	41 lbs	WR63-1242-5	54 lbs	AD63-1242-5	51 lbs	Y	N	N	N
12" x 48"	WR63-1248	52 lbs	AD63-1248	43 lbs	WR63-1248-5	61 lbs	AD63-1248-5	56 lbs	Y	Y	Y	Y
12" x 60"	WR63-1260	60 lbs	AD63-1260	51 lbs	WR63-1260-5	74 lbs	AD63-1260-5	69 lbs	Y	Y	Y	Y
12" x 72"	WR63-1272	68 lbs	AD63-1272	59 lbs	WR63-1272-5	85 lbs	AD63-1272-5	80 lbs	Y	Y	Y	N
14" x 24"	WR63-1424	40 lbs	AD63-1424	31 lbs	WR63-1424-5	46 lbs	AD63-1424-5	41 lbs	Y	N	N	N
14" x 30"	WR63-1430	44 lbs	AD63-1430	35 lbs	WR63-1430-5	51 lbs	AD63-1430-5	46 lbs	Y	Y	N	N
14" x 36"	WR63-1436	48 lbs	AD63-1436	39 lbs	WR63-1436-5	56 lbs	AD63-1436-5	51 lbs	Y	Y	Y	N
14" x 42"	WR63-1442	56 lbs	AD63-1442	47 lbs	WR63-1442-5	66 lbs	AD63-1442-5	61 lbs	Y	Y	N	N
14" x 48"	WR63-1448	60 lbs	AD63-1448	51 lbs	WR63-1448-5	71 lbs	AD63-1448-5	66 lbs	Y	Y	Y	N
14" x 54"	WR63-1454	64 lbs	AD63-1454	55 lbs	WR63-1454-5	76 lbs	AD63-1454-5	71 lbs	Y	Y	Y	N
14" x 60"	WR63-1460	72 lbs	AD63-1460	63 lbs	WR63-1460-5	86 lbs	AD63-1460-5	81 lbs	Y	Y	Y	N
14" x 72"	WR63-1472	84 lbs	AD63-1472	75 lbs	WR63-1472-5	101 lbs	AD63-1472-5	96 lbs	Y	Y	Y	N
18" x 24"	WR63-1824	44 lbs	AD63-1824	35 lbs	WR63-1824-5	51 lbs	AD63-1824-5	46 lbs	Y	Y	N	Y
18" x 30"	WR63-1830	48 lbs	AD63-1830	39 lbs	WR63-1830-5	56 lbs	AD63-1830-5	51 lbs	Y	Y	Y	N
18" x 36"	WR63-1836	54 lbs	AD63-1836	49 lbs	WR63-1836-5	64 lbs	AD63-1836-5	61 lbs	Y	Y	Y	Y
18" x 42"	WR63-1842	58 lbs	AD63-1842	53 lbs	WR63-1842-5	69 lbs	AD63-1842-5	66 lbs	Y	Y	Y	N
18" x 48"	WR63-1848	62 lbs	AD63-1848	57 lbs	WR63-1848-5	76 lbs	AD63-1848-5	73 lbs	Y	Y	Y	Y
18" x 54"	WR63-1854	74 lbs	AD63-1854	69 lbs	WR63-1854-5	89 lbs	AD63-1854-5	86 lbs	Y	Y	Y	Y
18" x 60"	WR63-1860	82 lbs	AD63-1860	77 lbs	WR63-1860-5	99 lbs	AD63-1860-5	96 lbs	Y	Y	Y	Y
18" x 72"	WR63-1872	94 lbs	AD63-1872	89 lbs	WR63-1872-5	114 lbs	AD63-1872-5	111 lbs	Y	Y	Y	Y
21" x 24"	WR63-2124	46 lbs	AD63-2124	41 lbs	WR63-2124-5	54 lbs	AD63-2124-5	51 lbs	Y	Y	N	N
21" x 30"	WR63-2130	50 lbs	AD63-2130	45 lbs	WR63-2130-5	59 lbs	AD63-2130-5	56 lbs	Y	Y	N	N
21" x 36"	WR63-2136	58 lbs	AD63-2136	53 lbs	WR63-2136-5	69 lbs	AD63-2136-5	66 lbs	Y	Y	Y	N
21" x 42"	WR63-2142	62 lbs	AD63-2142	57 lbs	WR63-2142-5	74 lbs	AD63-2142-5	71 lbs	Y	Y	N	N
21" x 48"	WR63-2148	70 lbs	AD63-2148	65 lbs	WR63-2148-5	84 lbs	AD63-2148-5	81 lbs	Y	Y	Y	N
21" x 54"	WR63-2154	78 lbs	AD63-2154	73 lbs	WR63-2154-5	94 lbs	AD63-2154-5	91 lbs	Y	Y	Y	N
21" x 60"	WR63-2160	86 lbs	AD63-2160	81 lbs	WR63-2160-5	104 lbs	AD63-2160-5	101 lbs	Y	Y	Y	N
21" x 72"	WR63-2172	110 lbs	AD63-2172	105 lbs	WR63-2172-5	134 lbs	AD63-2172-5	131 lbs	Y	Y	Y	N
24" x 24"	WR63-2424	50 lbs	AD63-2424	45 lbs	WR63-2424-5	59 lbs	AD63-2424-5	56 lbs	Y	Y	N	Y
24" x 30"	WR63-2430	58 lbs	AD63-2430	53 lbs	WR63-2430-5	69 lbs	AD63-2430-5	66 lbs	Y	Y	Y	N
24" x 36"	WR63-2436	66 lbs	AD63-2436	61 lbs	WR63-2436-5	79 lbs	AD63-2436-5	76 lbs	Y	Y	Y	Y
24" x 42"	WR63-2442	74 lbs	AD63-2442	69 lbs	WR63-2442-5	89 lbs	AD63-2442-5	86 lbs	Y	Y	Y	N
24" x 48"	WR63-2448	78 lbs	AD63-2448	73 lbs	WR63-2448-5	94 lbs	AD63-2448-5	91 lbs	Y	Y	Y	Y
24" x 54"	WR63-2454	86 lbs	AD63-2454	81 lbs	WR63-2454-5	104 lbs	AD63-2454-5	101 lbs	Y	Y	Y	N
24" x 60"	WR63-2460	98 lbs	AD63-2460	93 lbs	WR63-2460-5	119 lbs	AD63-2460-5	116 lbs	Y	Y	Y	Y
24" x 72"	WR63-2472	118 lbs	AD63-2472	113 lbs	WR63-2472-5	144 lbs	AD63-2472-5	141 lbs	Y	Y	Y	Y
30" x 36"	WR63-3036	74 lbs	AD63-3036	69 lbs	WR63-3036-5	89 lbs	AD63-3036-5	86 lbs	Y	Y	Y	N
30" x 42"	WR63-3042	86 lbs	AD63-3042	81 lbs	WR63-3042-5	104 lbs	AD63-3042-5	101 lbs	Y	Y	Y	N
30" x 48"	WR63-3048	98 lbs	AD63-3048	93 lbs	WR63-3048-5	119 lbs	AD63-3048-5	116 lbs	Y	Y	Y	N
30" x 60"	WR63-3060	122 lbs	AD63-3060	117 lbs	WR63-3060-5	149 lbs	AD63-3060-5	146 lbs	Y	Y	Y	N
30" x 72"	WR63-3072	138 lbs	AD63-3072	133 lbs	WR63-3072-5	169 lbs	AD63-3072-5	166 lbs	Y	Y	Y	N
36" x 36"	WR63-3636	86 lbs	AD63-3636	81 lbs	WR63-3636-5	104 lbs	AD63-3636-5	101 lbs	Y	Y	Y	N
36" x 48"	WR63-3648	106 lbs	AD63-3648	101 lbs	WR63-3648-5	129 lbs	AD63-3648-5	126 lbs	Y	Y	Y	N
36" x 60"	WR63-3660	130 lbs	AD63-3660	125 lbs	WR63-3660-5	159 lbs	AD63-3660-5	156 lbs	Y	Y	Y	Y
36" x 72"	WR63-3672	138 lbs	AD63-3672	133 lbs	WR63-3672-5	173 lbs	AD63-3672-5	170 lbs	Y	Y	Y	Y

Shelving units include 4 posts and 4 or 5 shelves. Add-On units include 2 posts, 4 or 5 shelves and 8 or 10 S-Hooks. Y (Yes) N (No)

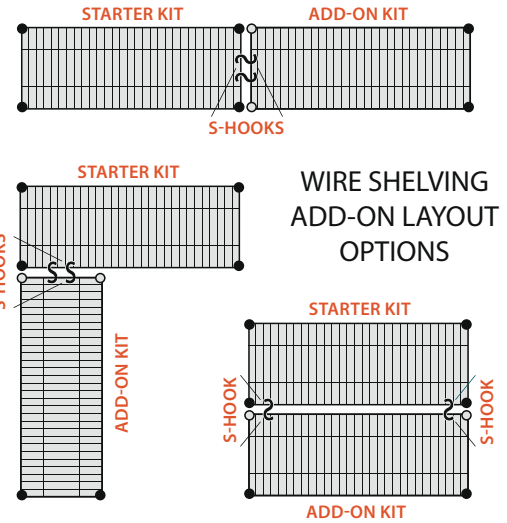

Starter Kits



Heavy-duty shelving unit allows up to 800 lb. shelf capacity. Starter kits come complete with 4 posts and 4 or 5 shelves. Additional shelves may be purchased separately. See chart on **pg.104**. Mobilize starter kit shelving unit using optional mobile kit, **WR-00H**, see **pg.153**. **Finishes:** Chrome, Stainless Steel, Proform and Black



MOBILIZE YOUR WIRE SHELVING

DB - Donut Bumper
Non-marking donut bumper used to protect walls and help cushion impact.

WR-00H (Mobile Kit)*
Set of four swivel polyurethane 5" x 1-1/4" casters, two with brakes. Can be used with all units shown. 1,200 lb. load capacity. *Mobile kits recommended only for shelves 18" and wider.

TO CHOOSE FINISH ADD FINISH SUFFIX TO MODEL NO.

Ex: **Chrome** WR74-1236C
Stainless WR74-1236S
Proform WR74-1236P
Black WR74-1236BK

Ex: **Chrome** WR74-1236C-5
Stainless WR74-1236S-5
Proform WR74-1236P-5
Black WR74-1236BK-5

Chrome
Stainless
Proform
BK Black

SHELF W" x L"	74"H WIRE SHELVING 4 SHELVES				74"H WIRE SHELVING 5 SHELVES				AVAILABLE	
	STARTER KIT	ADD-ON KIT	STARTER KIT	ADD-ON KIT	STARTER KIT	ADD-ON KIT	STARTER KIT	ADD-ON KIT	FINISHES	
	MODEL NO.	SHIP WGT	MODEL NO.	SHIP WGT	MODEL NO.	SHIP WGT	MODEL NO.	SHIP WGT	C	S P BK
12" x 36"	WR74-1236	44 lbs	AD74-1236	38 lbs	WR74-1236-5	51 lbs	AD74-1236-5	47 lbs	Y	Y Y Y Y
12" x 42"	WR74-1242	48 lbs	AD74-1242	42 lbs	WR74-1242-5	56 lbs	AD74-1242-5	52 lbs	Y	N N N N
12" x 48"	WR74-1248	52 lbs	AD74-1248	46 lbs	WR74-1248-5	61 lbs	AD74-1248-5	57 lbs	Y	Y Y Y Y
12" x 60"	WR74-1260	60 lbs	AD74-1260	54 lbs	WR74-1260-5	74 lbs	AD74-1260-5	70 lbs	Y	Y Y Y N
12" x 72"	WR74-1272	68 lbs	AD74-1272	62 lbs	WR74-1272-5	85 lbs	AD74-1272-5	81 lbs	Y	Y Y N N
14" x 24"	WR74-1424	40 lbs	AD74-1424	34 lbs	WR74-1424-5	46 lbs	AD74-1424-5	42 lbs	Y	N N N N
14" x 30"	WR74-1430	44 lbs	AD74-1430	38 lbs	WR74-1430-5	51 lbs	AD74-1430-5	47 lbs	Y	Y N N N
14" x 36"	WR74-1436	48 lbs	AD74-1436	42 lbs	WR74-1436-5	56 lbs	AD74-1436-5	52 lbs	Y	Y Y N N
14" x 42"	WR74-1442	56 lbs	AD74-1442	50 lbs	WR74-1442-5	66 lbs	AD74-1442-5	62 lbs	Y	Y N N N
14" x 48"	WR74-1448	60 lbs	AD74-1448	54 lbs	WR74-1448-5	71 lbs	AD74-1448-5	67 lbs	Y	Y Y N N
14" x 54"	WR74-1454	64 lbs	AD74-1454	58 lbs	WR74-1454-5	76 lbs	AD74-1454-5	72 lbs	Y	Y N N N
14" x 60"	WR74-1460	72 lbs	AD74-1460	66 lbs	WR74-1460-5	86 lbs	AD74-1460-5	82 lbs	Y	Y Y N N
14" x 72"	WR74-1472	84 lbs	AD74-1472	78 lbs	WR74-1472-5	101 lbs	AD74-1472-5	97 lbs	Y	Y Y N N
18" x 24"	WR74-1824	44 lbs	AD74-1824	38 lbs	WR74-1824-5	51 lbs	AD74-1824-5	47 lbs	Y	Y N Y Y
18" x 30"	WR74-1830	48 lbs	AD74-1830	42 lbs	WR74-1830-5	56 lbs	AD74-1830-5	52 lbs	Y	Y Y Y Y
18" x 36"	WR74-1836	56 lbs	AD74-1836	50 lbs	WR74-1836-5	66 lbs	AD74-1836-5	62 lbs	Y	Y Y Y N
18" x 42"	WR74-1842	60 lbs	AD74-1842	54 lbs	WR74-1842-5	71 lbs	AD74-1842-5	67 lbs	Y	Y Y N N
18" x 48"	WR74-1848	64 lbs	AD74-1848	58 lbs	WR74-1848-5	78 lbs	AD74-1848-5	74 lbs	Y	Y Y Y Y
18" x 54"	WR74-1854	76 lbs	AD74-1854	70 lbs	WR74-1854-5	91 lbs	AD74-1854-5	87 lbs	Y	Y Y Y N
18" x 60"	WR74-1860	84 lbs	AD74-1860	78 lbs	WR74-1860-5	101 lbs	AD74-1860-5	97 lbs	Y	Y Y Y Y
18" x 72"	WR74-1872	96 lbs	AD74-1872	90 lbs	WR74-1872-5	116 lbs	AD74-1872-5	112 lbs	Y	Y Y Y Y
21" x 24"	WR74-2124	48 lbs	AD74-2124	42 lbs	WR74-2124-5	56 lbs	AD74-2124-5	52 lbs	Y	Y N N N
21" x 30"	WR74-2130	52 lbs	AD74-2130	46 lbs	WR74-2130-5	61 lbs	AD74-2130-5	57 lbs	Y	Y N N N
21" x 36"	WR74-2136	60 lbs	AD74-2136	54 lbs	WR74-2136-5	71 lbs	AD74-2136-5	67 lbs	Y	Y Y N N
21" x 42"	WR74-2142	64 lbs	AD74-2142	58 lbs	WR74-2142-5	76 lbs	AD74-2142-5	72 lbs	Y	Y N N N
21" x 48"	WR74-2148	72 lbs	AD74-2148	66 lbs	WR74-2148-5	86 lbs	AD74-2148-5	82 lbs	Y	Y Y N N
21" x 54"	WR74-2154	80 lbs	AD74-2154	74 lbs	WR74-2154-5	96 lbs	AD74-2154-5	92 lbs	Y	Y N N N
21" x 60"	WR74-2160	88 lbs	AD74-2160	82 lbs	WR74-2160-5	106 lbs	AD74-2160-5	102 lbs	Y	Y Y N N
21" x 72"	WR74-2172	112 lbs	AD74-2172	106 lbs	WR74-2172-5	136 lbs	AD74-2172-5	132 lbs	Y	Y Y N N
24" x 24"	WR74-2424	52 lbs	AD74-2424	46 lbs	WR74-2424-5	61 lbs	AD74-2424-5	57 lbs	Y	Y N Y Y
24" x 30"	WR74-2430	60 lbs	AD74-2430	54 lbs	WR74-2430-5	71 lbs	AD74-2430-5	67 lbs	Y	Y Y Y N
24" x 36"	WR74-2436	68 lbs	AD74-2436	62 lbs	WR74-2436-5	81 lbs	AD74-2436-5	77 lbs	Y	Y Y Y Y
24" x 42"	WR74-2442	76 lbs	AD74-2442	70 lbs	WR74-2442-5	91 lbs	AD74-2442-5	87 lbs	Y	Y Y N N
24" x 48"	WR74-2448	80 lbs	AD74-2448	74 lbs	WR74-2448-5	96 lbs	AD74-2448-5	92 lbs	Y	Y Y Y Y
24" x 54"	WR74-2454	88 lbs	AD74-2454	82 lbs	WR74-2454-5	106 lbs	AD74-2454-5	102 lbs	Y	Y Y Y N
24" x 60"	WR74-2460	100 lbs	AD74-2460	94 lbs	WR74-2460-5	121 lbs	AD74-2460-5	117 lbs	Y	Y Y Y Y
24" x 72"	WR74-2472	120 lbs	AD74-2472	114 lbs	WR74-2472-5	146 lbs	AD74-2472-5	142 lbs	Y	Y Y Y Y
30" x 36"	WR74-3036	76 lbs	AD74-3036	70 lbs	WR74-3036-5	91 lbs	AD74-3036-5	87 lbs	Y	Y Y N N
30" x 42"	WR74-3042	88 lbs	AD74-3042	82 lbs	WR74-3042-5	106 lbs	AD74-3042-5	102 lbs	Y	Y Y Y N
30" x 48"	WR74-3048	100 lbs	AD74-3048	94 lbs	WR74-3048-5	121 lbs	AD74-3048-5	117 lbs	Y	Y Y N N
30" x 60"	WR74-3060	124 lbs	AD74-3060	118 lbs	WR74-3060-5	151 lbs	AD74-3060-5	147 lbs	Y	Y Y N N
30" x 72"	WR74-3072	140 lbs	AD74-3072	134 lbs	WR74-3072-5	171 lbs	AD74-3072-5	167 lbs	Y	Y Y N N
36" x 36"	WR74-3636	88 lbs	AD74-3636	82 lbs	WR74-3636-5	106 lbs	AD74-3636-5	102 lbs	Y	Y Y Y N
36" x 48"	WR74-3648	108 lbs	AD74-3648	102 lbs	WR74-3648-5	131 lbs	AD74-3648-5	127 lbs	Y	Y Y N N
36" x 60"	WR74-3660	132 lbs	AD74-3660	126 lbs	WR74-3660-5	161 lbs	AD74-3660-5	157 lbs	Y	Y Y Y Y
36" x 72"	WR74-3672	140 lbs	AD74-3672	134 lbs	WR74-3672-5	175 lbs	AD74-3672-5	171 lbs	Y	Y Y Y Y

Shelving units include 4 posts and 4 or 5 shelves. Add-On units include 2 posts, 4 or 5 shelves and 8 or 10 S-Hooks.

Y (Yes) N (No)



4 SHELF STARTER KITS
Proform Finish



5 SHELF STARTER KITS
Black Finish



LOWEST PRICE GUARANTEED!

Add-On Kits

Additional Add-On kit allows you to expand your Starter kit by sharing a set of posts. Configuration options include straight line, back to back and right angles (L-Shape). Add-On kits come complete with 2 posts, 4 or 5 shelves and 8 or 10 S-Hooks. Additional shelves and posts may be purchased separately. See chart on pg.104. Units with Add-On kit cannot be made mobile. **Finishes:** Chrome, Stainless Steel, Proform and Black

600 - 800 lb.
LOAD CAPACITY
PER SHELF

TO CHOOSE FINISH ADD FINISH SUFFIX TO MODEL NO.

Ex: **Chrome** WR86-1236C
Stainless WR86-1236S
Proform WR86-1236P
Black WR86-1236BK

Ex: **Chrome** WR86-1236C-5
Stainless WR86-1236S-5
Proform WR86-1236P-5
Black WR86-1236BK-5

Chrome
Stainless
Proform
BK Black

SHELF W" x L"	86"H WIRE SHELVING 4 SHELVES				86"H WIRE SHELVING 5 SHELVES				AVAILABLE FINISHES	
	STARTER KIT MODEL NO.	SHIP WGT	ADD-ON KIT MODEL NO.	SHIP WGT	STARTER KIT MODEL NO.	SHIP WGT	ADD-ON KIT MODEL NO.	SHIP WGT	C	S P BK
12" x 36"	WR86-1236	48 lbs	AD86-1236	40 lbs	WR86-1236-5	55 lbs	AD86-1236-5	49 lbs	Y	Y Y Y Y
12" x 42"	WR86-1242	52 lbs	AD86-1242	44 lbs	WR86-1242-5	60 lbs	AD86-1242-5	54 lbs	Y	N N N N
12" x 48"	WR86-1248	56 lbs	AD86-1248	48 lbs	WR86-1248-5	65 lbs	AD86-1248-5	59 lbs	Y	Y Y Y Y
12" x 60"	WR86-1260	64 lbs	AD86-1260	56 lbs	WR86-1260-5	78 lbs	AD86-1260-5	72 lbs	Y	Y Y Y N
12" x 72"	WR86-1272	72 lbs	AD86-1272	64 lbs	WR86-1272-5	89 lbs	AD86-1272-5	83 lbs	Y	Y Y Y N
14" x 24"	WR86-1424	44 lbs	AD86-1424	36 lbs	WR86-1424-5	50 lbs	AD86-1424-5	44 lbs	Y	N N N N
14" x 30"	WR86-1430	48 lbs	AD86-1430	40 lbs	WR86-1430-5	55 lbs	AD86-1430-5	49 lbs	Y	Y Y N N
14" x 36"	WR86-1436	52 lbs	AD86-1436	44 lbs	WR86-1436-5	60 lbs	AD86-1436-5	54 lbs	Y	Y Y N N
14" x 42"	WR86-1442	60 lbs	AD86-1442	52 lbs	WR86-1442-5	70 lbs	AD86-1442-5	64 lbs	Y	Y N N N
14" x 48"	WR86-1448	64 lbs	AD86-1448	56 lbs	WR86-1448-5	75 lbs	AD86-1448-5	69 lbs	Y	Y Y N N
14" x 54"	WR86-1454	68 lbs	AD86-1454	60 lbs	WR86-1454-5	80 lbs	AD86-1454-5	74 lbs	Y	Y Y N N
14" x 60"	WR86-1460	76 lbs	AD86-1460	68 lbs	WR86-1460-5	90 lbs	AD86-1460-5	84 lbs	Y	Y Y N N
14" x 72"	WR86-1472	88 lbs	AD86-1472	80 lbs	WR86-1472-5	105 lbs	AD86-1472-5	99 lbs	Y	Y Y N N
18" x 24"	WR86-1824	48 lbs	AD86-1824	40 lbs	WR86-1824-5	55 lbs	AD86-1824-5	49 lbs	Y	Y N Y Y
18" x 30"	WR86-1830	52 lbs	AD86-1830	44 lbs	WR86-1830-5	60 lbs	AD86-1830-5	54 lbs	Y	Y Y N Y
18" x 36"	WR86-1836	60 lbs	AD86-1836	52 lbs	WR86-1836-5	60 lbs	AD86-1836-5	64 lbs	Y	Y Y Y Y
18" x 42"	WR86-1842	64 lbs	AD86-1842	56 lbs	WR86-1842-5	75 lbs	AD86-1842-5	69 lbs	Y	Y Y N N
18" x 48"	WR86-1848	68 lbs	AD86-1848	60 lbs	WR86-1848-5	82 lbs	AD86-1848-5	76 lbs	Y	Y Y Y Y
18" x 54"	WR86-1854	80 lbs	AD86-1854	72 lbs	WR86-1854-5	95 lbs	AD86-1854-5	89 lbs	Y	Y Y N N
18" x 60"	WR86-1860	88 lbs	AD86-1860	80 lbs	WR86-1860-5	105 lbs	AD86-1860-5	99 lbs	Y	Y Y Y Y
18" x 72"	WR86-1872	100 lbs	AD86-1872	92 lbs	WR86-1872-5	120 lbs	AD86-1872-5	114 lbs	Y	Y Y Y Y
21" x 24"	WR86-2124	52 lbs	AD86-2124	44 lbs	WR86-2124-5	60 lbs	AD86-2124-5	54 lbs	Y	Y N N N
21" x 30"	WR86-2130	56 lbs	AD86-2130	48 lbs	WR86-2130-5	65 lbs	AD86-2130-5	59 lbs	Y	Y N N N
21" x 36"	WR86-2136	64 lbs	AD86-2136	56 lbs	WR86-2136-5	75 lbs	AD86-2136-5	69 lbs	Y	Y Y N N
21" x 42"	WR86-2142	68 lbs	AD86-2142	60 lbs	WR86-2142-5	80 lbs	AD86-2142-5	74 lbs	Y	Y N N N
21" x 48"	WR86-2148	76 lbs	AD86-2148	68 lbs	WR86-2148-5	90 lbs	AD86-2148-5	84 lbs	Y	Y Y N N
21" x 54"	WR86-2154	84 lbs	AD86-2154	76 lbs	WR86-2154-5	100 lbs	AD86-2154-5	94 lbs	Y	Y Y N N
21" x 60"	WR86-2160	92 lbs	AD86-2160	84 lbs	WR86-2160-5	110 lbs	AD86-2160-5	104 lbs	Y	Y Y N N
21" x 72"	WR86-2172	116 lbs	AD86-2172	108 lbs	WR86-2172-5	140 lbs	AD86-2172-5	134 lbs	Y	Y Y N N
24" x 24"	WR86-2424	56 lbs	AD86-2424	48 lbs	WR86-2424-5	65 lbs	AD86-2424-5	59 lbs	Y	Y N Y Y
24" x 30"	WR86-2430	64 lbs	AD86-2430	56 lbs	WR86-2430-5	75 lbs	AD86-2430-5	69 lbs	Y	Y Y N Y
24" x 36"	WR86-2436	72 lbs	AD86-2436	64 lbs	WR86-2436-5	85 lbs	AD86-2436-5	79 lbs	Y	Y Y Y Y
24" x 42"	WR86-2442	80 lbs	AD86-2442	72 lbs	WR86-2442-5	95 lbs	AD86-2442-5	89 lbs	Y	Y Y N N
24" x 48"	WR86-2448	84 lbs	AD86-2448	76 lbs	WR86-2448-5	100 lbs	AD86-2448-5	94 lbs	Y	Y Y Y Y
24" x 54"	WR86-2454	92 lbs	AD86-2454	84 lbs	WR86-2454-5	110 lbs	AD86-2454-5	104 lbs	Y	Y Y N N
24" x 60"	WR86-2460	104 lbs	AD86-2460	96 lbs	WR86-2460-5	125 lbs	AD86-2460-5	119 lbs	Y	Y Y Y Y
24" x 72"	WR86-2472	124 lbs	AD86-2472	116 lbs	WR86-2472-5	150 lbs	AD86-2472-5	144 lbs	Y	Y Y Y Y
30" x 36"	WR86-3036	80 lbs	AD86-3036	72 lbs	WR86-3036-5	95 lbs	AD86-3036-5	89 lbs	Y	Y Y N N
30" x 42"	WR86-3042	92 lbs	AD86-3042	84 lbs	WR86-3042-5	110 lbs	AD86-3042-5	104 lbs	Y	Y Y N N
30" x 48"	WR86-3048	104 lbs	AD86-3048	96 lbs	WR86-3048-5	125 lbs	AD86-3048-5	119 lbs	Y	Y Y N N
30" x 60"	WR86-3060	128 lbs	AD86-3060	120 lbs	WR86-3060-5	155 lbs	AD86-3060-5	149 lbs	Y	Y Y N N
30" x 72"	WR86-3072	144 lbs	AD86-3072	136 lbs	WR86-3072-5	175 lbs	AD86-3072-5	169 lbs	Y	Y Y N N
36" x 36"	WR86-3636	92 lbs	AD86-3636	84 lbs	WR86-3636-5	110 lbs	AD86-3636-5	104 lbs	Y	Y Y N N
36" x 48"	WR86-3648	112 lbs	AD86-3648	104 lbs	WR86-3648-5	135 lbs	AD86-3648-5	129 lbs	Y	Y Y N N
36" x 60"	WR86-3660	136 lbs	AD86-3660	128 lbs	WR86-3660-5	165 lbs	AD86-3660-5	159 lbs	Y	Y Y Y Y
36" x 72"	WR86-3672	144 lbs	AD86-3672	136 lbs	WR86-3672-5	179 lbs	AD86-3672-5	173 lbs	Y	Y Y Y Y

Shelving units include 4 posts and 4 or 5 shelves. Add-On units include 2 posts, 4 or 5 shelves and 8 or 10 S-Hooks. Y (Yes) N (No)

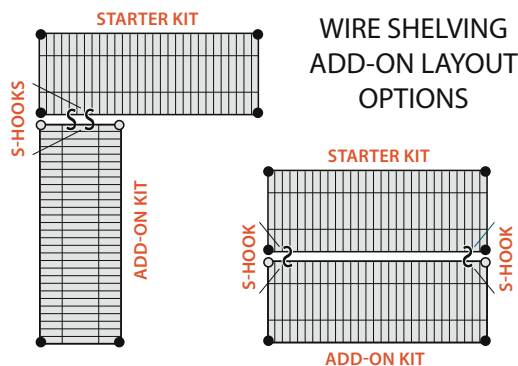
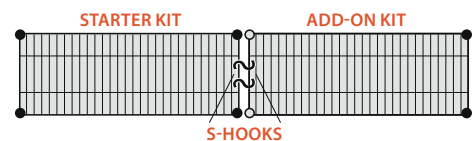

S-HOOKS
For continuous runs of shelving. Two hooks should be placed per shelf where two posts are not utilized.



4 SHELF BACK TO BACK SYSTEM
Chrome Finish



4 Shelf Starter Kits

Solid shelves are a solution where dirt, dust and spills are a potential issue. The solid flat surface allows for storage from small to large items and the marine edge perimeter prevents spillage. The double hemmed 18 gauge galvanized steel gives the solid shelf excellent strength characteristics. All solid shelf units consist of 4 shelves and 4 posts. Mobilize starter kit shelving unit using optional mobile kit **WR-00H**, see **pg. 153**. **Finish:** Galvanized Steel



MOBILIZE YOUR SHELVING

DB - Donut Bumper

Non-marking donut bumper used to protect walls and help cushion impact.

WR-00H (Mobile Kit)*

Set of four swivel polyurethane 5" x 1-1/4" casters, two with brakes. Can be used with all units shown. 1,200 lb. load capacity. *Mobile kits recommended only for shelves 18" and wider.



4 SHELF STARTER KITS



QSMC

Shelf Clamp

Shelf Clamp eliminates 2 post per shelving section. Two **QSMC** clamps are required per shelf. **Finish:** Aluminum

SHELF W" x L"	54"H GALVANIZED SOLID SHELVING 4 SHELVES				63"H GALVANIZED SOLID SHELVING 4 SHELVES			
	STARTER KIT		ADD-ON KIT		STARTER KIT		ADD-ON KIT	
	MODEL NO.	SHIP WGT	MODEL NO.	SHIP WGT	MODEL NO.	SHIP WGT	MODEL NO.	SHIP WGT
14" x 36"	WR54-1436SG	68 lbs	AD54-1436SG	65 lbs	WR63-1436SG	72 lbs	AD63-1436SG	67 lbs
14" x 42"	WR54-1442SG	72 lbs	AD54-1442SG	69 lbs	WR63-1442SG	76 lbs	AD63-1442SG	71 lbs
14" x 48"	WR54-1448SG	80 lbs	AD54-1448SG	77 lbs	WR63-1448SG	84 lbs	AD63-1448SG	79 lbs
14" x 54"	WR54-1454SG	92 lbs	AD54-1454SG	89 lbs	WR63-1454SG	96 lbs	AD63-1454SG	91 lbs
14" x 60"	WR54-1460SG	100 lbs	AD54-1460SG	97 lbs	WR63-1460SG	104 lbs	AD63-1460SG	99 lbs
14" x 72"	WR54-1472SG	116 lbs	AD54-1472SG	113 lbs	WR63-1472SG	120 lbs	AD63-1472SG	115 lbs
18" x 24"	WR54-1824SG	56 lbs	AD54-1824SG	53 lbs	WR63-1824SG	60 lbs	AD63-1824SG	55 lbs
18" x 30"	WR54-1830SG	68 lbs	AD54-1830SG	65 lbs	WR63-1830SG	72 lbs	AD63-1830SG	67 lbs
18" x 36"	WR54-1836SG	76 lbs	AD54-1836SG	73 lbs	WR63-1836SG	80 lbs	AD63-1836SG	75 lbs
18" x 42"	WR54-1842SG	84 lbs	AD54-1842SG	81 lbs	WR63-1842SG	88 lbs	AD63-1842SG	83 lbs
18" x 48"	WR54-1848SG	92 lbs	AD54-1848SG	89 lbs	WR63-1848SG	96 lbs	AD63-1848SG	91 lbs
18" x 54"	WR54-1854SG	100 lbs	AD54-1854SG	97 lbs	WR63-1854SG	104 lbs	AD63-1854SG	99 lbs
18" x 60"	WR54-1860SG	108 lbs	AD54-1860SG	105 lbs	WR63-1860SG	112 lbs	AD63-1860SG	107 lbs
18" x 72"	WR54-1872SG	120 lbs	AD54-1872SG	117 lbs	WR63-1872SG	124 lbs	AD63-1872SG	119 lbs
21" x 24"	WR54-2124SG	64 lbs	AD54-2124SG	61 lbs	WR63-2124SG	68 lbs	AD63-2124SG	63 lbs
21" x 30"	WR54-2130SG	72 lbs	AD54-2130SG	69 lbs	WR63-2130SG	76 lbs	AD63-2130SG	71 lbs
21" x 36"	WR54-2136SG	84 lbs	AD54-2136SG	81 lbs	WR63-2136SG	88 lbs	AD63-2136SG	83 lbs
21" x 42"	WR54-2142SG	96 lbs	AD54-2142SG	93 lbs	WR63-2142SG	100 lbs	AD63-2142SG	95 lbs
21" x 48"	WR54-2148SG	104 lbs	AD54-2148SG	101 lbs	WR63-2148SG	108 lbs	AD63-2148SG	103 lbs
21" x 54"	WR54-2154SG	112 lbs	AD54-2154SG	109 lbs	WR63-2154SG	116 lbs	AD63-2154SG	111 lbs
21" x 60"	WR54-2160SG	124 lbs	AD54-2160SG	121 lbs	WR63-2160SG	128 lbs	AD63-2160SG	123 lbs
21" x 72"	WR54-2172SG	132 lbs	AD54-2172SG	129 lbs	WR63-2172SG	136 lbs	AD63-2172SG	131 lbs
24" x 24"	WR54-2424SG	72 lbs	AD54-2424SG	69 lbs	WR63-2424SG	76 lbs	AD63-2424SG	71 lbs
24" x 30"	WR54-2430SG	80 lbs	AD54-2430SG	77 lbs	WR63-2430SG	84 lbs	AD63-2430SG	79 lbs
24" x 36"	WR54-2436SG	88 lbs	AD54-2436SG	85 lbs	WR63-2436SG	92 lbs	AD63-2436SG	87 lbs
24" x 42"	WR54-2442SG	100 lbs	AD54-2442SG	97 lbs	WR63-2442SG	104 lbs	AD63-2442SG	99 lbs
24" x 48"	WR54-2448SG	108 lbs	AD54-2448SG	105 lbs	WR63-2448SG	112 lbs	AD63-2448SG	107 lbs
24" x 54"	WR54-2454SG	124 lbs	AD54-2454SG	121 lbs	WR63-2454SG	128 lbs	AD63-2454SG	123 lbs
24" x 60"	WR54-2460SG	136 lbs	AD54-2460SG	133 lbs	WR63-2460SG	140 lbs	AD63-2460SG	135 lbs
24" x 72"	WR54-2472SG	148 lbs	AD54-2472SG	145 lbs	WR63-2472SG	152 lbs	AD63-2472SG	147 lbs

Shelving units include 4 posts and 4 shelves. Add-On units include 2 posts, 4 shelves and 8 shelf clamps.

18 GAUGE GALVANIZED STEEL

4 Shelf Add-On Kits

Additional Add-On kit allows you to expand your Starter kit by sharing a set of posts. Configuration options include straight line, back to back and right angles (*L-Shape*). Add-on units consist of 4 shelves, 2 posts and 8 shelf clamps. Additional shelves and posts may be purchased separately, see chart on **pg. 105**. Units with Add-On kit cannot be made mobile. **Finish:** Galvanized Steel

SHELF W" x L"	74"H GALVANIZED SOLID SHELVING 4 SHELVES				86"H GALVANIZED SOLID SHELVING 4 SHELVES			
	STARTER KIT		ADD-ON KIT		STARTER KIT		ADD-ON KIT	
	MODEL NO.	SHIP WGT	MODEL NO.	SHIP WGT	MODEL NO.	SHIP WGT	MODEL NO.	SHIP WGT
14" x 36"	WR74-1436SG	72 lbs	AD74-1436SG	67 lbs	WR86-1436SG	76 lbs	AD86-1436SG	69 lbs
14" x 42"	WR74-1442SG	76 lbs	AD74-1442SG	71 lbs	WR86-1442SG	80 lbs	AD86-1442SG	73 lbs
14" x 48"	WR74-1448SG	84 lbs	AD74-1448SG	79 lbs	WR86-1448SG	88 lbs	AD86-1448SG	81 lbs
14" x 54"	WR74-1454SG	96 lbs	AD74-1454SG	91 lbs	WR86-1454SG	100 lbs	AD86-1454SG	93 lbs
14" x 60"	WR74-1460SG	104 lbs	AD74-1460SG	99 lbs	WR86-1460SG	108 lbs	AD86-1460SG	101 lbs
14" x 72"	WR74-1472SG	120 lbs	AD74-1472SG	115 lbs	WR86-1472SG	124 lbs	AD86-1472SG	117 lbs
18" x 24"	WR74-1824SG	60 lbs	AD74-1824SG	55 lbs	WR86-1824SG	64 lbs	AD86-1824SG	57 lbs
18" x 30"	WR74-1830SG	72 lbs	AD74-1830SG	67 lbs	WR86-1830SG	76 lbs	AD86-1830SG	69 lbs
18" x 36"	WR74-1836SG	80 lbs	AD74-1836SG	75 lbs	WR86-1836SG	84 lbs	AD86-1836SG	77 lbs
18" x 42"	WR74-1842SG	88 lbs	AD74-1842SG	83 lbs	WR86-1842SG	92 lbs	AD86-1842SG	85 lbs
18" x 48"	WR74-1848SG	96 lbs	AD74-1848SG	91 lbs	WR86-1848SG	100 lbs	AD86-1848SG	93 lbs
18" x 54"	WR74-1854SG	104 lbs	AD74-1854SG	99 lbs	WR86-1854SG	108 lbs	AD86-1854SG	101 lbs
18" x 60"	WR74-1860SG	112 lbs	AD74-1860SG	107 lbs	WR86-1860SG	116 lbs	AD86-1860SG	109 lbs
18" x 72"	WR74-1872SG	124 lbs	AD74-1872SG	119 lbs	WR86-1872SG	128 lbs	AD86-1872SG	121 lbs
21" x 24"	WR74-2124SG	68 lbs	AD74-2124SG	63 lbs	WR86-2124SG	72 lbs	AD86-2124SG	65 lbs
21" x 30"	WR74-2130SG	76 lbs	AD74-2130SG	71 lbs	WR86-2130SG	80 lbs	AD86-2130SG	73 lbs
21" x 36"	WR74-2136SG	88 lbs	AD74-2136SG	83 lbs	WR86-2136SG	92 lbs	AD86-2136SG	85 lbs
21" x 42"	WR74-2142SG	100 lbs	AD74-2142SG	95 lbs	WR86-2142SG	104 lbs	AD86-2142SG	97 lbs
21" x 48"	WR74-2148SG	108 lbs	AD74-2148SG	103 lbs	WR86-2148SG	112 lbs	AD86-2148SG	105 lbs
21" x 54"	WR74-2154SG	116 lbs	AD74-2154SG	111 lbs	WR86-2154SG	120 lbs	AD86-2154SG	113 lbs
21" x 60"	WR74-2160SG	128 lbs	AD74-2160SG	123 lbs	WR86-2160SG	132 lbs	AD86-2160SG	125 lbs
21" x 72"	WR74-2172SG	136 lbs	AD74-2172SG	131 lbs	WR86-2172SG	140 lbs	AD86-2172SG	133 lbs
24" x 24"	WR74-2424SG	76 lbs	AD74-2424SG	71 lbs	WR86-2424SG	80 lbs	AD86-2424SG	73 lbs
24" x 30"	WR74-2430SG	84 lbs	AD74-2430SG	79 lbs	WR86-2430SG	88 lbs	AD86-2430SG	81 lbs
24" x 36"	WR74-2436SG	92 lbs	AD74-2436SG	87 lbs	WR86-2436SG	96 lbs	AD86-2436SG	89 lbs
24" x 42"	WR74-2442SG	104 lbs	AD74-2442SG	99 lbs	WR86-2442SG	108 lbs	AD86-2442SG	101 lbs
24" x 48"	WR74-2448SG	112 lbs	AD74-2448SG	107 lbs	WR86-2448SG	116 lbs	AD86-2448SG	109 lbs
24" x 54"	WR74-2454SG	128 lbs	AD74-2454SG	123 lbs	WR86-2454SG	132 lbs	AD86-2454SG	125 lbs
24" x 60"	WR74-2460SG	140 lbs	AD74-2460SG	135 lbs	WR86-2460SG	144 lbs	AD86-2460SG	137 lbs
24" x 72"	WR74-2472SG	152 lbs	AD74-2472SG	147 lbs	WR86-2472SG	156 lbs	AD86-2472SG	149 lbs

Shelving units include 4 posts and 4 shelves. Add-On units include 2 posts, 4 shelves and 8 shelf clamps.

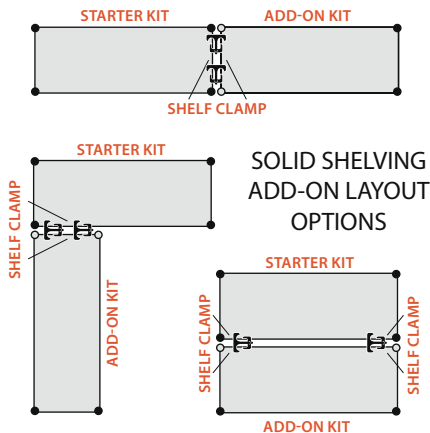

SOLID SHELVING ADD-ON LAYOUT OPTIONS



LOWEST PRICE GUARANTEED!

5 Shelf Starter Kits

SHELF W" x L"	54"H GALVANIZED SOLID SHELVING 5 SHELVES			63"H GALVANIZED SOLID SHELVING 5 SHELVES		
	STARTER KIT	ADD-ON KIT	ADD-ON KIT	STARTER KIT	ADD-ON KIT	ADD-ON KIT
	MODEL NO.	SHIP WGT	MODEL NO.	SHIP WGT	MODEL NO.	SHIP WGT
14" x 36"	WR54-1436SG-5	82 lbs	AD54-1436SG-5	79 lbs	WR63-1436SG-5	86 lbs
14" x 42"	WR54-1442SG-5	87 lbs	AD54-1442SG-5	84 lbs	WR63-1442SG-5	91 lbs
14" x 48"	WR54-1448SG-5	97 lbs	AD54-1448SG-5	94 lbs	WR63-1448SG-5	101 lbs
14" x 54"	WR54-1454SG-5	112 lbs	AD54-1454SG-5	109 lbs	WR63-1454SG-5	116 lbs
14" x 60"	WR54-1460SG-5	122 lbs	AD54-1460SG-5	119 lbs	WR63-1460SG-5	126 lbs
14" x 72"	WR54-1472SG-5	142 lbs	AD54-1472SG-5	139 lbs	WR63-1472SG-5	146 lbs
18" x 24"	WR54-1824SG-5	67 lbs	AD54-1824SG-5	64 lbs	WR63-1824SG-5	71 lbs
18" x 30"	WR54-1830SG-5	82 lbs	AD54-1830SG-5	79 lbs	WR63-1830SG-5	86 lbs
18" x 36"	WR54-1836SG-5	92 lbs	AD54-1836SG-5	89 lbs	WR63-1836SG-5	96 lbs
18" x 42"	WR54-1842SG-5	102 lbs	AD54-1842SG-5	99 lbs	WR63-1842SG-5	106 lbs
18" x 48"	WR54-1848SG-5	112 lbs	AD54-1848SG-5	109 lbs	WR63-1848SG-5	116 lbs
18" x 54"	WR54-1854SG-5	122 lbs	AD54-1854SG-5	119 lbs	WR63-1854SG-5	126 lbs
18" x 60"	WR54-1860SG-5	132 lbs	AD54-1860SG-5	129 lbs	WR63-1860SG-5	136 lbs
18" x 72"	WR54-1872SG-5	147 lbs	AD54-1872SG-5	144 lbs	WR63-1872SG-5	151 lbs
21" x 24"	WR54-2124SG-5	77 lbs	AD54-2124SG-5	74 lbs	WR63-2124SG-5	81 lbs
21" x 30"	WR54-2130SG-5	87 lbs	AD54-2130SG-5	84 lbs	WR63-2130SG-5	91 lbs
21" x 36"	WR54-2136SG-5	102 lbs	AD54-2136SG-5	99 lbs	WR63-2136SG-5	106 lbs
21" x 42"	WR54-2142SG-5	117 lbs	AD54-2142SG-5	114 lbs	WR63-2142SG-5	121 lbs
21" x 48"	WR54-2148SG-5	127 lbs	AD54-2148SG-5	124 lbs	WR63-2148SG-5	131 lbs
21" x 54"	WR54-2154SG-5	137 lbs	AD54-2154SG-5	134 lbs	WR63-2154SG-5	141 lbs
21" x 60"	WR54-2160SG-5	152 lbs	AD54-2160SG-5	149 lbs	WR63-2160SG-5	156 lbs
21" x 72"	WR54-2172SG-5	162 lbs	AD54-2172SG-5	159 lbs	WR63-2172SG-5	166 lbs
24" x 24"	WR54-2424SG-5	87 lbs	AD54-2424SG-5	84 lbs	WR63-2424SG-5	91 lbs
24" x 30"	WR54-2430SG-5	97 lbs	AD54-2430SG-5	94 lbs	WR63-2430SG-5	101 lbs
24" x 36"	WR54-2436SG-5	107 lbs	AD54-2436SG-5	104 lbs	WR63-2436SG-5	111 lbs
24" x 42"	WR54-2442SG-5	122 lbs	AD54-2442SG-5	119 lbs	WR63-2442SG-5	126 lbs
24" x 48"	WR54-2448SG-5	132 lbs	AD54-2448SG-5	129 lbs	WR63-2448SG-5	136 lbs
24" x 54"	WR54-2454SG-5	152 lbs	AD54-2454SG-5	149 lbs	WR63-2454SG-5	156 lbs
24" x 60"	WR54-2460SG-5	167 lbs	AD54-2460SG-5	164 lbs	WR63-2460SG-5	171 lbs
24" x 72"	WR54-2472SG-5	182 lbs	AD54-2472SG-5	179 lbs	WR63-2472SG-5	186 lbs

Shelving units include 4 posts and 5 shelves. Add-On units include 2 posts, 5 shelves and 10 shelf clamps.

18 GAUGE GALVANIZED STEEL

SHELF W" x L"	74"H GALVANIZED SOLID SHELVING 5 SHELVES			86"H GALVANIZED SOLID SHELVING 5 SHELVES		
	STARTER KIT	ADD-ON KIT	ADD-ON KIT	STARTER KIT	ADD-ON KIT	ADD-ON KIT
	MODEL NO.	SHIP WGT	MODEL NO.	SHIP WGT	MODEL NO.	SHIP WGT
14" x 36"	WR74-1436SG-5	86 lbs	AD74-1436SG-5	81 lbs	WR86-1436SG-5	90 lbs
14" x 42"	WR74-1442SG-5	91 lbs	AD74-1442SG-5	86 lbs	WR86-1442SG-5	95 lbs
14" x 48"	WR74-1448SG-5	101 lbs	AD74-1448SG-5	91 lbs	WR86-1448SG-5	105 lbs
14" x 54"	WR74-1454SG-5	116 lbs	AD74-1454SG-5	111 lbs	WR86-1454SG-5	120 lbs
14" x 60"	WR74-1460SG-5	126 lbs	AD74-1460SG-5	121 lbs	WR86-1460SG-5	130 lbs
14" x 72"	WR74-1472SG-5	146 lbs	AD74-1472SG-5	141 lbs	WR86-1472SG-5	150 lbs
18" x 24"	WR74-1824SG-5	71 lbs	AD74-1824SG-5	66 lbs	WR86-1824SG-5	75 lbs
18" x 30"	WR74-1830SG-5	86 lbs	AD74-1830SG-5	81 lbs	WR86-1830SG-5	90 lbs
18" x 36"	WR74-1836SG-5	96 lbs	AD74-1836SG-5	91 lbs	WR86-1836SG-5	100 lbs
18" x 42"	WR74-1842SG-5	106 lbs	AD74-1842SG-5	101 lbs	WR86-1842SG-5	110 lbs
18" x 48"	WR74-1848SG-5	116 lbs	AD74-1848SG-5	111 lbs	WR86-1848SG-5	120 lbs
18" x 54"	WR74-1854SG-5	126 lbs	AD74-1854SG-5	121 lbs	WR86-1854SG-5	130 lbs
18" x 60"	WR74-1860SG-5	136 lbs	AD74-1860SG-5	131 lbs	WR86-1860SG-5	140 lbs
18" x 72"	WR74-1872SG-5	151 lbs	AD74-1872SG-5	151 lbs	WR86-1872SG-5	155 lbs
21" x 24"	WR74-2124SG-5	81 lbs	AD74-2124SG-5	76 lbs	WR86-2124SG-5	85 lbs
21" x 30"	WR74-2130SG-5	91 lbs	AD74-2130SG-5	86 lbs	WR86-2130SG-5	95 lbs
21" x 36"	WR74-2136SG-5	106 lbs	AD74-2136SG-5	101 lbs	WR86-2136SG-5	110 lbs
21" x 42"	WR74-2142SG-5	121 lbs	AD74-2142SG-5	116 lbs	WR86-2142SG-5	125 lbs
21" x 48"	WR74-2148SG-5	131 lbs	AD74-2148SG-5	121 lbs	WR86-2148SG-5	135 lbs
21" x 54"	WR74-2154SG-5	141 lbs	AD74-2154SG-5	136 lbs	WR86-2154SG-5	145 lbs
21" x 60"	WR74-2160SG-5	156 lbs	AD74-2160SG-5	151 lbs	WR86-2160SG-5	160 lbs
21" x 72"	WR74-2172SG-5	166 lbs	AD74-2172SG-5	166 lbs	WR86-2172SG-5	170 lbs
24" x 24"	WR74-2424SG-5	91 lbs	AD74-2424SG-5	86 lbs	WR86-2424SG-5	95 lbs
24" x 30"	WR74-2430SG-5	101 lbs	AD74-2430SG-5	96 lbs	WR86-2430SG-5	105 lbs
24" x 36"	WR74-2436SG-5	111 lbs	AD74-2436SG-5	106 lbs	WR86-2436SG-5	115 lbs
24" x 42"	WR74-2442SG-5	126 lbs	AD74-2442SG-5	121 lbs	WR86-2442SG-5	130 lbs
24" x 48"	WR74-2448SG-5	136 lbs	AD74-2448SG-5	131 lbs	WR86-2448SG-5	140 lbs
24" x 54"	WR74-2454SG-5	156 lbs	AD74-2454SG-5	151 lbs	WR86-2454SG-5	160 lbs
24" x 60"	WR74-2460SG-5	171 lbs	AD74-2460SG-5	166 lbs	WR86-2460SG-5	175 lbs
24" x 72"	WR74-2472SG-5	186 lbs	AD74-2472SG-5	181 lbs	WR86-2472SG-5	205 lbs

Shelving units include 4 posts and 5 shelves. Add-On units include 2 posts, 5 shelves and 10 shelf clamps.

Solid shelves are a solution where dirt, dust and spills are a potential issue. The solid flat surface allows for storage from small to large items and the marine edge perimeter prevents spillage. The double hemmed 18 gauge galvanized steel gives the solid shelf excellent strength characteristics. All solid shelf units consist of 5 shelves and 4 posts. Mobilize starter kit shelving unit using optional mobile kit **WR-00H**, see **pg. 153**. **Finish:** Galvanized Steel



MOBILIZE YOUR SHELVING

DB - Donut Bumper
Non-marking donut bumper used to protect walls and help cushion impact.
WR-00H (Mobile Kit)*
Set of four swivel polyurethane 5" x 1-1/4" casters, two with brakes. Can be used with all units shown. 1,200 lb. load capacity. *Mobile kits recommended only for shelves 18" and wider.



QSMC Shelf Clamp
Shelf Clamp eliminates 2 post per shelving section. Two QSMC clamps are required per shelf.
Finish: Aluminum



5 SHELF ADD-ON KITS

5 Shelf Add-On Kits

Additional Add-On kit allows you to expand your Starter kit by sharing a set of posts. Configuration options include straight line, back to back and right angles (*L-Shape*). Add-on units consist of 5 shelves, 2 posts and 10 shelf clamps. Additional shelves and posts may be purchased separately, see chart on **pg. 105**. Units with Add-On kit cannot be made mobile. **Finish:** Galvanized Steel

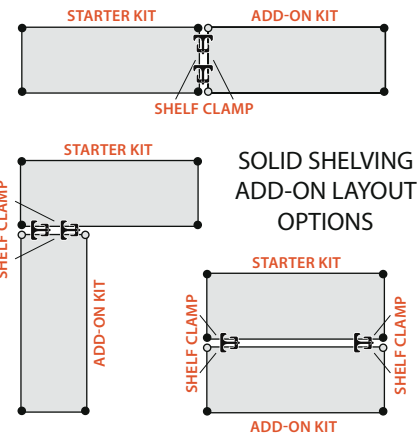



4 Shelf Starter Kits

Solid shelves are a solution where dirt, dust and spills are a potential issue. The solid flat surface allows for storage from small to large items and the marine edge perimeter prevents spillage. The double hemmed 18 gauge 304 stainless steel gives the solid shelf excellent strength characteristics. All solid shelf units consist of 4 shelves and 4 posts. Mobilize starter kit shelving unit using optional mobile kit **WR-00HS**, see **pg. 153**. **Finish:** Stainless Steel



MOBILIZE YOUR SHELVING
DB - Donut Bumper
 Non-marking donut bumper used to protect walls and help cushion impact.
WR-00HS (Mobile Kit)*
 Set of four swivel 5" x 1-1/4" polyurethane stainless steel casters with zerk grease fittings, 2 with brake. Can be used with all units shown. 1,200 lb. load capacity. *Mobile kits recommended only for shelves 18" and wider.



4 SHELF STARTER KIT



QSMC Shelf Clamp
 Shelf Clamp eliminates 2 post per shelving section. Two QSMC clamps are required per shelf.
Finish: Aluminum

4 Shelf Add-On Kits

Additional Add-On kit allows you to expand your Starter kit by sharing a set of posts. Configuration options include straight line, back to back and right angles (L-Shape). Add-on units consist of 4 shelves, 2 posts and 8 shelf clamps. Additional shelves and posts may be purchased separately, see chart on **pg. 105**. Units with Add-On kit cannot be made mobile. **Finish:** Stainless Steel

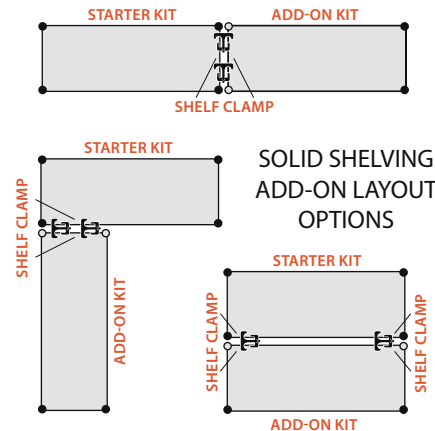

SHELF W" x L"	54"H STAINLESS SOLID SHELVING 4 SHELVES				63"H STAINLESS SOLID SHELVING 4 SHELVES			
	STARTER KIT		ADD-ON KIT		STARTER KIT		ADD-ON KIT	
	MODEL NO.	SHIP WGT	MODEL NO.	SHIP WGT	MODEL NO.	SHIP WGT	MODEL NO.	SHIP WGT
14" x 36"	WRS4-54-1436SS	68 lbs	WRSAD4-54-1436SS	65 lbs	WRS4-63-1436SS	72 lbs	WRSAD4-63-1436SS	67 lbs
14" x 42"	WRS4-54-1442SS	72 lbs	WRSAD4-54-1442SS	69 lbs	WRS4-63-1442SS	76 lbs	WRSAD4-63-1442SS	71 lbs
14" x 48"	WRS4-54-1448SS	80 lbs	WRSAD4-54-1448SS	77 lbs	WRS4-63-1448SS	84 lbs	WRSAD4-63-1448SS	79 lbs
14" x 54"	WRS4-54-1454SS	92 lbs	WRSAD4-54-1454SS	89 lbs	WRS4-63-1454SS	96 lbs	WRSAD4-63-1454SS	91 lbs
14" x 60"	WRS4-54-1460SS	100 lbs	WRSAD4-54-1460SS	97 lbs	WRS4-63-1460SS	104 lbs	WRSAD4-63-1460SS	99 lbs
14" x 72"	WRS4-54-1472SS	116 lbs	WRSAD4-54-1472SS	113 lbs	WRS4-63-1472SS	120 lbs	WRSAD4-63-1472SS	115 lbs
18" x 24"	WRS4-54-1824SS	56 lbs	WRSAD4-54-1824SS	53 lbs	WRS4-63-1824SS	60 lbs	WRSAD4-63-1824SS	55 lbs
18" x 30"	WRS4-54-1830SS	68 lbs	WRSAD4-54-1830SS	65 lbs	WRS4-63-1830SS	72 lbs	WRSAD4-63-1830SS	67 lbs
18" x 36"	WRS4-54-1836SS	76 lbs	WRSAD4-54-1836SS	73 lbs	WRS4-63-1836SS	80 lbs	WRSAD4-63-1836SS	75 lbs
18" x 42"	WRS4-54-1842SS	84 lbs	WRSAD4-54-1842SS	81 lbs	WRS4-63-1842SS	88 lbs	WRSAD4-63-1842SS	83 lbs
18" x 48"	WRS4-54-1848SS	92 lbs	WRSAD4-54-1848SS	89 lbs	WRS4-63-1848SS	96 lbs	WRSAD4-63-1848SS	91 lbs
18" x 54"	WRS4-54-1854SS	100 lbs	WRSAD4-54-1854SS	97 lbs	WRS4-63-1854SS	104 lbs	WRSAD4-63-1854SS	99 lbs
18" x 60"	WRS4-54-1860SS	108 lbs	WRSAD4-54-1860SS	105 lbs	WRS4-63-1860SS	112 lbs	WRSAD4-63-1860SS	107 lbs
18" x 72"	WRS4-54-1872SS	120 lbs	WRSAD4-54-1872SS	117 lbs	WRS4-63-1872SS	124 lbs	WRSAD4-63-1872SS	119 lbs
21" x 24"	WRS4-54-2124SS	64 lbs	WRSAD4-54-2124SS	61 lbs	WRS4-63-2124SS	68 lbs	WRSAD4-63-2124SS	63 lbs
21" x 30"	WRS4-54-2130SS	72 lbs	WRSAD4-54-2130SS	69 lbs	WRS4-63-2130SS	76 lbs	WRSAD4-63-2130SS	71 lbs
21" x 36"	WRS4-54-2136SS	84 lbs	WRSAD4-54-2136SS	81 lbs	WRS4-63-2136SS	88 lbs	WRSAD4-63-2136SS	83 lbs
21" x 42"	WRS4-54-2142SS	96 lbs	WRSAD4-54-2142SS	93 lbs	WRS4-63-2142SS	100 lbs	WRSAD4-63-2142SS	95 lbs
21" x 48"	WRS4-54-2148SS	104 lbs	WRSAD4-54-2148SS	101 lbs	WRS4-63-2148SS	108 lbs	WRSAD4-63-2148SS	103 lbs
21" x 54"	WRS4-54-2154SS	112 lbs	WRSAD4-54-2154SS	109 lbs	WRS4-63-2154SS	116 lbs	WRSAD4-63-2154SS	111 lbs
21" x 60"	WRS4-54-2160SS	124 lbs	WRSAD4-54-2160SS	121 lbs	WRS4-63-2160SS	128 lbs	WRSAD4-63-2160SS	123 lbs
21" x 72"	WRS4-54-2172SS	132 lbs	WRSAD4-54-2172SS	129 lbs	WRS4-63-2172SS	136 lbs	WRSAD4-63-2172SS	131 lbs
24" x 24"	WRS4-54-2424SS	72 lbs	WRSAD4-54-2424SS	69 lbs	WRS4-63-2424SS	76 lbs	WRSAD4-63-2424SS	71 lbs
24" x 30"	WRS4-54-2430SS	80 lbs	WRSAD4-54-2430SS	77 lbs	WRS4-63-2430SS	84 lbs	WRSAD4-63-2430SS	79 lbs
24" x 36"	WRS4-54-2436SS	88 lbs	WRSAD4-54-2436SS	85 lbs	WRS4-63-2436SS	92 lbs	WRSAD4-63-2436SS	87 lbs
24" x 42"	WRS4-54-2442SS	100 lbs	WRSAD4-54-2442SS	97 lbs	WRS4-63-2442SS	104 lbs	WRSAD4-63-2442SS	99 lbs
24" x 48"	WRS4-54-2448SS	108 lbs	WRSAD4-54-2448SS	105 lbs	WRS4-63-2448SS	112 lbs	WRSAD4-63-2448SS	107 lbs
24" x 54"	WRS4-54-2454SS	124 lbs	WRSAD4-54-2454SS	121 lbs	WRS4-63-2454SS	128 lbs	WRSAD4-63-2454SS	123 lbs
24" x 60"	WRS4-54-2460SS	136 lbs	WRSAD4-54-2460SS	133 lbs	WRS4-63-2460SS	140 lbs	WRSAD4-63-2460SS	135 lbs
24" x 72"	WRS4-54-2472SS	148 lbs	WRSAD4-54-2472SS	145 lbs	WRS4-63-2472SS	152 lbs	WRSAD4-63-2472SS	147 lbs

Shelving units include 4 posts and 4 shelves. Add-On units include 2 posts, 4 shelves and 8 shelf clamps.

304 STAINLESS STEEL

SHELF W" x L"	74"H STAINLESS SOLID SHELVING 4 SHELVES				86"H STAINLESS SOLID SHELVING 4 SHELVES			
	STARTER KIT		ADD-ON KIT		STARTER KIT		ADD-ON KIT	
	MODEL NO.	SHIP WGT	MODEL NO.	SHIP WGT	MODEL NO.	SHIP WGT	MODEL NO.	SHIP WGT
14" x 36"	WRS4-74-1436SS	72 lbs	WRSAD4-74-1436SS	67 lbs	WRS4-86-1436SS	76 lbs	WRSAD4-86-1436SS	69 lbs
14" x 42"	WRS4-74-1442SS	76 lbs	WRSAD4-74-1442SS	71 lbs	WRS4-86-1442SS	80 lbs	WRSAD4-86-1442SS	73 lbs
14" x 48"	WRS4-74-1448SS	84 lbs	WRSAD4-74-1448SS	79 lbs	WRS4-86-1448SS	88 lbs	WRSAD4-86-1448SS	81 lbs
14" x 54"	WRS4-74-1454SS	96 lbs	WRSAD4-74-1454SS	91 lbs	WRS4-86-1454SS	100 lbs	WRSAD4-86-1454SS	93 lbs
14" x 60"	WRS4-74-1460SS	104 lbs	WRSAD4-74-1460SS	99 lbs	WRS4-86-1460SS	108 lbs	WRSAD4-86-1460SS	101 lbs
14" x 72"	WRS4-74-1472SS	120 lbs	WRSAD4-74-1472SS	115 lbs	WRS4-86-1472SS	124 lbs	WRSAD4-86-1472SS	117 lbs
18" x 24"	WRS4-74-1824SS	60 lbs	WRSAD4-74-1824SS	55 lbs	WRS4-86-1824SS	64 lbs	WRSAD4-86-1824SS	57 lbs
18" x 30"	WRS4-74-1830SS	72 lbs	WRSAD4-74-1830SS	67 lbs	WRS4-86-1830SS	76 lbs	WRSAD4-86-1830SS	69 lbs
18" x 36"	WRS4-74-1836SS	80 lbs	WRSAD4-74-1836SS	75 lbs	WRS4-86-1836SS	84 lbs	WRSAD4-86-1836SS	77 lbs
18" x 42"	WRS4-74-1842SS	88 lbs	WRSAD4-74-1842SS	83 lbs	WRS4-86-1842SS	92 lbs	WRSAD4-86-1842SS	85 lbs
18" x 48"	WRS4-74-1848SS	96 lbs	WRSAD4-74-1848SS	91 lbs	WRS4-86-1848SS	100 lbs	WRSAD4-86-1848SS	93 lbs
18" x 54"	WRS4-74-1854SS	104 lbs	WRSAD4-74-1854SS	99 lbs	WRS4-86-1854SS	108 lbs	WRSAD4-86-1854SS	101 lbs
18" x 60"	WRS4-74-1860SS	112 lbs	WRSAD4-74-1860SS	107 lbs	WRS4-86-1860SS	116 lbs	WRSAD4-86-1860SS	109 lbs
18" x 72"	WRS4-74-1872SS	124 lbs	WRSAD4-74-1872SS	119 lbs	WRS4-86-1872SS	128 lbs	WRSAD4-86-1872SS	121 lbs
21" x 24"	WRS4-74-2124SS	68 lbs	WRSAD4-74-2124SS	63 lbs	WRS4-86-2124SS	72 lbs	WRSAD4-86-2124SS	65 lbs
21" x 30"	WRS4-74-2130SS	76 lbs	WRSAD4-74-2130SS	71 lbs	WRS4-86-2130SS	80 lbs	WRSAD4-86-2130SS	73 lbs
21" x 36"	WRS4-74-2136SS	88 lbs	WRSAD4-74-2136SS	83 lbs	WRS4-86-2136SS	92 lbs	WRSAD4-86-2136SS	85 lbs
21" x 42"	WRS4-74-2142SS	100 lbs	WRSAD4-74-2142SS	95 lbs	WRS4-86-2142SS	104 lbs	WRSAD4-86-2142SS	97 lbs
21" x 48"	WRS4-74-2148SS	108 lbs	WRSAD4-74-2148SS	103 lbs	WRS4-86-2148SS	112 lbs	WRSAD4-86-2148SS	105 lbs
21" x 54"	WRS4-74-2154SS	116 lbs	WRSAD4-74-2154SS	111 lbs	WRS4-86-2154SS	120 lbs	WRSAD4-86-2154SS	113 lbs
21" x 60"	WRS4-74-2160SS	128 lbs	WRSAD4-74-2160SS	123 lbs	WRS4-86-2160SS	132 lbs	WRSAD4-86-2160SS	125 lbs
21" x 72"	WRS4-74-2172SS	136 lbs	WRSAD4-74-2172SS	131 lbs	WRS4-86-2172SS	140 lbs	WRSAD4-86-2172SS	133 lbs
24" x 24"	WRS4-74-2424SS	76 lbs	WRSAD4-74-2424SS	71 lbs	WRS4-86-2424SS	80 lbs	WRSAD4-86-2424SS	73 lbs
24" x 30"	WRS4-74-2430SS	84 lbs	WRSAD4-74-2430SS	79 lbs	WRS4-86-2430SS	88 lbs	WRSAD4-86-2430SS	81 lbs
24" x 36"	WRS4-74-2436SS	92 lbs	WRSAD4-74-2436SS	87 lbs	WRS4-86-2436SS	96 lbs	WRSAD4-86-2436SS	89 lbs
24" x 42"	WRS4-74-2442SS	104 lbs	WRSAD4-74-2442SS	99 lbs	WRS4-86-2442SS	108 lbs	WRSAD4-86-2442SS	101 lbs
24" x 48"	WRS4-74-2448SS	112 lbs	WRSAD4-74-2448SS	107 lbs	WRS4-86-2448SS	116 lbs	WRSAD4-86-2448SS	109 lbs
24" x 54"	WRS4-74-2454SS	128 lbs	WRSAD4-74-2454SS	123 lbs	WRS4-86-2454SS	132 lbs	WRSAD4-86-2454SS	125 lbs
24" x 60"	WRS4-74-2460SS	140 lbs	WRSAD4-74-2460SS	135 lbs	WRS4-86-2460SS	144 lbs	WRSAD4-86-2460SS	137 lbs
24" x 72"	WRS4-74-2472SS	152 lbs	WRSAD4-74-2472SS	147 lbs	WRS4-86-2472SS	156 lbs	WRSAD4-86-2472SS	149 lbs

Shelving units include 4 posts and 4 shelves. Add-On units include 2 posts, 4 shelves and 8 shelf clamps.



LOWEST PRICE GUARANTEED!

SHELF W" x L"	54"H STAINLESS SOLID SHELVING 5 SHELVES				63"H STAINLESS SOLID SHELVING 5 SHELVES			
	STARTER KIT		ADD-ON KIT		STARTER KIT		ADD-ON KIT	
	MODEL NO.	SHIP WGT	MODEL NO.	SHIP WGT	MODEL NO.	SHIP WGT	MODEL NO.	SHIP WGT
14" x 36"	WRS5-54-1436SS	82 lbs	WRSAD5-54-1436SS	79 lbs	WRS5-63-1436SS	86 lbs	WRSAD5-63-1436SS	81 lbs
14" x 42"	WRS5-54-1442SS	87 lbs	WRSAD5-54-1442SS	84 lbs	WRS5-63-1442SS	91 lbs	WRSAD5-63-1442SS	86 lbs
14" x 48"	WRS5-54-1448SS	97 lbs	WRSAD5-54-1448SS	94 lbs	WRS5-63-1448SS	101 lbs	WRSAD5-63-1448SS	96 lbs
14" x 54"	WRS5-54-1454SS	112 lbs	WRSAD5-54-1454SS	109 lbs	WRS5-63-1454SS	116 lbs	WRSAD5-63-1454SS	111 lbs
14" x 60"	WRS5-54-1460SS	122 lbs	WRSAD5-54-1460SS	119 lbs	WRS5-63-1460SS	126 lbs	WRSAD5-63-1460SS	121 lbs
14" x 72"	WRS5-54-1472SS	142 lbs	WRSAD5-54-1472SS	139 lbs	WRS5-63-1472SS	146 lbs	WRSAD5-63-1472SS	141 lbs
18" x 24"	WRS5-54-1824SS	67 lbs	WRSAD5-54-1824SS	64 lbs	WRS5-63-1824SS	71 lbs	WRSAD5-63-1824SS	66 lbs
18" x 30"	WRS5-54-1830SS	82 lbs	WRSAD5-54-1830SS	79 lbs	WRS5-63-1830SS	86 lbs	WRSAD5-63-1830SS	81 lbs
18" x 36"	WRS5-54-1836SS	92 lbs	WRSAD5-54-1836SS	89 lbs	WRS5-63-1836SS	96 lbs	WRSAD5-63-1836SS	91 lbs
18" x 42"	WRS5-54-1842SS	102 lbs	WRSAD5-54-1842SS	99 lbs	WRS5-63-1842SS	106 lbs	WRSAD5-63-1842SS	101 lbs
18" x 48"	WRS5-54-1848SS	112 lbs	WRSAD5-54-1848SS	109 lbs	WRS5-63-1848SS	116 lbs	WRSAD5-63-1848SS	111 lbs
18" x 54"	WRS5-54-1854SS	122 lbs	WRSAD5-54-1854SS	119 lbs	WRS5-63-1854SS	126 lbs	WRSAD5-63-1854SS	121 lbs
18" x 60"	WRS5-54-1860SS	132 lbs	WRSAD5-54-1860SS	129 lbs	WRS5-63-1860SS	136 lbs	WRSAD5-63-1860SS	131 lbs
18" x 72"	WRS5-54-1872SS	147 lbs	WRSAD5-54-1872SS	144 lbs	WRS5-63-1872SS	151 lbs	WRSAD5-63-1872SS	146 lbs
21" x 24"	WRS5-54-2124SS	77 lbs	WRSAD5-54-2124SS	74 lbs	WRS5-63-2124SS	81 lbs	WRSAD5-63-2124SS	76 lbs
21" x 30"	WRS5-54-2130SS	87 lbs	WRSAD5-54-2130SS	84 lbs	WRS5-63-2130SS	91 lbs	WRSAD5-63-2130SS	86 lbs
21" x 36"	WRS5-54-2136SS	102 lbs	WRSAD5-54-2136SS	99 lbs	WRS5-63-2136SS	106 lbs	WRSAD5-63-2136SS	101 lbs
21" x 42"	WRS5-54-2142SS	117 lbs	WRSAD5-54-2142SS	114 lbs	WRS5-63-2142SS	121 lbs	WRSAD5-63-2142SS	116 lbs
21" x 48"	WRS5-54-2148SS	127 lbs	WRSAD5-54-2148SS	124 lbs	WRS5-63-2148SS	131 lbs	WRSAD5-63-2148SS	126 lbs
21" x 54"	WRS5-54-2154SS	137 lbs	WRSAD5-54-2154SS	134 lbs	WRS5-63-2154SS	141 lbs	WRSAD5-63-2154SS	136 lbs
21" x 60"	WRS5-54-2160SS	152 lbs	WRSAD5-54-2160SS	149 lbs	WRS5-63-2160SS	156 lbs	WRSAD5-63-2160SS	151 lbs
21" x 72"	WRS5-54-2172SS	162 lbs	WRSAD5-54-2172SS	159 lbs	WRS5-63-2172SS	166 lbs	WRSAD5-63-2172SS	161 lbs
24" x 24"	WRS5-54-2424SS	87 lbs	WRSAD5-54-2424SS	84 lbs	WRS5-63-2424SS	91 lbs	WRSAD5-63-2424SS	86 lbs
24" x 30"	WRS5-54-2430SS	97 lbs	WRSAD5-54-2430SS	94 lbs	WRS5-63-2430SS	101 lbs	WRSAD5-63-2430SS	96 lbs
24" x 36"	WRS5-54-2436SS	107 lbs	WRSAD5-54-2436SS	104 lbs	WRS5-63-2436SS	111 lbs	WRSAD5-63-2436SS	106 lbs
24" x 42"	WRS5-54-2442SS	122 lbs	WRSAD5-54-2442SS	119 lbs	WRS5-63-2442SS	126 lbs	WRSAD5-63-2442SS	121 lbs
24" x 48"	WRS5-54-2448SS	132 lbs	WRSAD5-54-2448SS	129 lbs	WRS5-63-2448SS	136 lbs	WRSAD5-63-2448SS	131 lbs
24" x 54"	WRS5-54-2454SS	152 lbs	WRSAD5-54-2454SS	149 lbs	WRS5-63-2454SS	156 lbs	WRSAD5-63-2454SS	151 lbs
24" x 60"	WRS5-54-2460SS	167 lbs	WRSAD5-54-2460SS	164 lbs	WRS5-63-2460SS	171 lbs	WRSAD5-63-2460SS	166 lbs
24" x 72"	WRS5-54-2472SS	182 lbs	WRSAD5-54-2472SS	179 lbs	WRS5-63-2472SS	186 lbs	WRSAD5-63-2472SS	181 lbs

Shelving units include 4 posts and 5 shelves. Add-On units include 2 posts, 5 shelves and 10 shelf clamps.

304 STAINLESS STEEL

SHELF W" x L"	74"H STAINLESS SOLID SHELVING 5 SHELVES				86"H STAINLESS SOLID SHELVING 5 SHELVES			
	STARTER KIT		ADD-ON KIT		STARTER KIT		ADD-ON KIT	
	MODEL NO.	SHIP WGT	MODEL NO.	SHIP WGT	MODEL NO.	SHIP WGT	MODEL NO.	SHIP WGT
14" x 36"	WRS5-74-1436SS	86 lbs	WRSAD5-74-1436SS	81 lbs	WRS5-86-1436SS	90 lbs	WRSAD5-86-1436SS	83 lbs
14" x 42"	WRS5-74-1442SS	91 lbs	WRSAD5-74-1442SS	86 lbs	WRS5-86-1442SS	95 lbs	WRSAD5-86-1442SS	88 lbs
14" x 48"	WRS5-74-1448SS	101 lbs	WRSAD5-74-1448SS	91 lbs	WRS5-86-1448SS	105 lbs	WRSAD5-86-1448SS	98 lbs
14" x 54"	WRS5-74-1454SS	116 lbs	WRSAD5-74-1454SS	111 lbs	WRS5-86-1454SS	120 lbs	WRSAD5-86-1454SS	113 lbs
14" x 60"	WRS5-74-1460SS	126 lbs	WRSAD5-74-1460SS	121 lbs	WRS5-86-1460SS	130 lbs	WRSAD5-86-1460SS	123 lbs
14" x 72"	WRS5-74-1472SS	146 lbs	WRSAD5-74-1472SS	141 lbs	WRS5-86-1472SS	150 lbs	WRSAD5-86-1472SS	143 lbs
18" x 24"	WRS5-74-1824SS	71 lbs	WRSAD5-74-1824SS	66 lbs	WRS5-86-1824SS	75 lbs	WRSAD5-86-1824SS	68 lbs
18" x 30"	WRS5-74-1830SS	86 lbs	WRSAD5-74-1830SS	81 lbs	WRS5-86-1830SS	90 lbs	WRSAD5-86-1830SS	83 lbs
18" x 36"	WRS5-74-1836SS	96 lbs	WRSAD5-74-1836SS	91 lbs	WRS5-86-1836SS	100 lbs	WRSAD5-86-1836SS	93 lbs
18" x 42"	WRS5-74-1842SS	106 lbs	WRSAD5-74-1842SS	101 lbs	WRS5-86-1842SS	110 lbs	WRSAD5-86-1842SS	103 lbs
18" x 48"	WRS5-74-1848SS	116 lbs	WRSAD5-74-1848SS	111 lbs	WRS5-86-1848SS	120 lbs	WRSAD5-86-1848SS	113 lbs
18" x 54"	WRS5-74-1854SS	126 lbs	WRSAD5-74-1854SS	121 lbs	WRS5-86-1854SS	130 lbs	WRSAD5-86-1854SS	123 lbs
18" x 60"	WRS5-74-1860SS	136 lbs	WRSAD5-74-1860SS	131 lbs	WRS5-86-1860SS	140 lbs	WRSAD5-86-1860SS	133 lbs
18" x 72"	WRS5-74-1872SS	151 lbs	WRSAD5-74-1872SS	151 lbs	WRS5-86-1872SS	155 lbs	WRSAD5-86-1872SS	153 lbs
21" x 24"	WRS5-74-2124SS	81 lbs	WRSAD5-74-2124SS	76 lbs	WRS5-86-2124SS	85 lbs	WRSAD5-86-2124SS	78 lbs
21" x 30"	WRS5-74-2130SS	91 lbs	WRSAD5-74-2130SS	86 lbs	WRS5-86-2130SS	95 lbs	WRSAD5-86-2130SS	88 lbs
21" x 36"	WRS5-74-2136SS	106 lbs	WRSAD5-74-2136SS	101 lbs	WRS5-86-2136SS	110 lbs	WRSAD5-86-2136SS	103 lbs
21" x 42"	WRS5-74-2142SS	121 lbs	WRSAD5-74-2142SS	116 lbs	WRS5-86-2142SS	125 lbs	WRSAD5-86-2142SS	118 lbs
21" x 48"	WRS5-74-2148SS	131 lbs	WRSAD5-74-2148SS	121 lbs	WRS5-86-2148SS	135 lbs	WRSAD5-86-2148SS	123 lbs
21" x 54"	WRS5-74-2154SS	141 lbs	WRSAD5-74-2154SS	136 lbs	WRS5-86-2154SS	145 lbs	WRSAD5-86-2154SS	138 lbs
21" x 60"	WRS5-74-2160SS	156 lbs	WRSAD5-74-2160SS	151 lbs	WRS5-86-2160SS	160 lbs	WRSAD5-86-2160SS	153 lbs
21" x 72"	WRS5-74-2172SS	166 lbs	WRSAD5-74-2172SS	166 lbs	WRS5-86-2172SS	170 lbs	WRSAD5-86-2172SS	168 lbs
24" x 24"	WRS5-74-2424SS	91 lbs	WRSAD5-74-2424SS	86 lbs	WRS5-86-2424SS	95 lbs	WRSAD5-86-2424SS	88 lbs
24" x 30"	WRS5-74-2430SS	101 lbs	WRSAD5-74-2430SS	96 lbs	WRS5-86-2430SS	105 lbs	WRSAD5-86-2430SS	98 lbs
24" x 36"	WRS5-74-2436SS	111 lbs	WRSAD5-74-2436SS	106 lbs	WRS5-86-2436SS	115 lbs	WRSAD5-86-2436SS	108 lbs
24" x 42"	WRS5-74-2442SS	126 lbs	WRSAD5-74-2442SS	121 lbs	WRS5-86-2442SS	130 lbs	WRSAD5-86-2442SS	123 lbs
24" x 48"	WRS5-74-2448SS	136 lbs	WRSAD5-74-2448SS	131 lbs	WRS5-86-2448SS	140 lbs	WRSAD5-86-2448SS	133 lbs
24" x 54"	WRS5-74-2454SS	156 lbs	WRSAD5-74-2454SS	151 lbs	WRS5-86-2454SS	160 lbs	WRSAD5-86-2454SS	153 lbs
24" x 60"	WRS5-74-2460SS	171 lbs	WRSAD5-74-2460SS	166 lbs	WRS5-86-2460SS	175 lbs	WRSAD5-86-2460SS	168 lbs
24" x 72"	WRS5-74-2472SS	186 lbs	WRSAD5-74-2472SS	181 lbs	WRS5-86-2472SS	205 lbs	WRSAD5-86-2472SS	198 lbs

Shelving units include 4 posts and 5 shelves. Add-On units include 2 posts, 5 shelves and 10 shelf clamps.

5 Shelf Starter Kits

Solid shelves are a solution where dirt, dust and spills are a potential issue. The solid flat surface allows for storage from small to large items and the marine edge perimeter prevents spillage. The double hemmed 18 gauge 304 stainless steel gives the solid shelf excellent strength characteristics. All solid shelf units consist of 5 shelves and 4 posts. Mobilize starter kit shelving unit using optional mobile kit WR-00HS, see pg. 153. Finish: Stainless Steel



MOBILIZE YOUR SHELVING

DB - Donut Bumper
Non-marking donut bumper used to protect walls and help cushion impact.

WR-00HS (Mobile Kit)*
Set of four swivel 5" x 1-1/4" polyurethane stainless steel casters with zerk grease fittings, 2 with brake. Can be used with all units shown. 1,200 lb. load capacity. *Mobile kits recommended only for shelves 18" and wider.



QSMC Shelf Clamp
Shelf Clamp eliminates 2 post per shelving section. Two QSMC clamps are required per shelf. Finish: Aluminum



5 SHELF ADD-ON KIT

5 Shelf Add-On Kits

Additional Add-On kit allows you to expand your Starter kit by sharing a set of posts. Configuration options include straight line, back to back and right angles (L-Shape). Add-on units consist of 5 shelves, 2 posts and 10 shelf clamps. Additional shelves and posts may be purchased separately, see chart on pg. 105. Units with Add-On kit cannot be made mobile. Finish: Stainless Steel

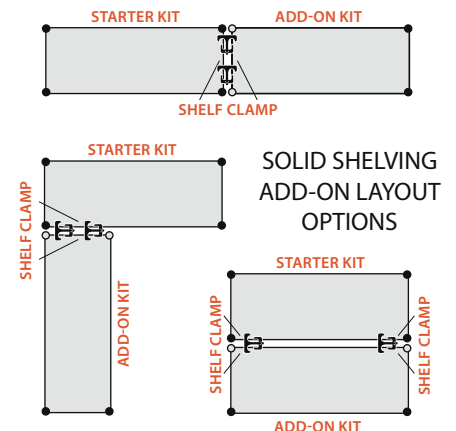

Convenient 1 Box Wire Shelving Units



4 shelf consumer grade wire shelving unit. Super competitive cost. All packed in 1 box for Super easy inventory control, shipping, and receiving

MODEL NO.	DIMENSIONS W" x L" x H"	SHIP WGT
RWR72-1830LD	18" x 30" x 72"	35 lbs
RWR72-1836LD	18" x 36" x 72"	38 lbs
RWR72-1842LD	18" x 42" x 72"	42 lbs
RWR72-1848LD	18" x 48" x 72"	46 lbs
RWR72-2430LD	24" x 30" x 72"	40 lbs
RWR72-2436LD	24" x 36" x 72"	46 lbs
RWR72-2442LD	24" x 42" x 72"	51 lbs
RWR72-2448LD	24" x 48" x 72"	56 lbs

SUPER LOW PRICE

SUPER LOW TRANSIT COST

PERFORMANCE FEATURES:

- 300 lb. load capacity per shelf
- Snap together design assembles in minutes
- Wire design allows for air circulation and minimal dust buildup
- Shelves easily adjust on 1" centers to your exact needs
- Ideal storage solution for any commercial, office, warehouse or home application
- Bright chrome finish
- Includes posts, shelves, and all needed hardware - all in one box.
- No tools required



4 SHELF UNIT
Chrome Finish

SINGLE BOX SHIPMENT

300 lb. LOAD CAPACITY PER SHELF



MOBILIZE YOUR SHELVING

W-PLI - Post Insert

Each unit will require one 4-pack.

WR-3 (Mobile Kit)

Set of four 3" polyurethane casters, all with brakes. Can be used with all units shown. 800 lb. load capacity.



AVAILABLE Inside the Box
4 posts, 4 wire shelves and 4 packs of split sleeves (4 pairs each)



Grid-Store Wall Mounted Systems

Grid-Store System provides a strong, versatile solution for organization and storage of small, medium and large supplies. A wide selection of accessories allow for easy storage of items ranging from catheters to crutches. Heavy-duty wall brackets firmly secure panels to walls or any flat surface. Heavy gauge wire grid (1/4" rod) construction allows for secure storage as well as visibility and dust and dirt free storage. Durable white gloss finish. Grid hooks and accessories are fabricated using 1/4" diameter wire, allowing heavy-duty application storage.

GRID-STORE HOOKS

Each hook is a full 1/4" in diameter and ideal for hanging prepackaged items. Available in 3 lengths.

GRID-STORE HOOK TUBE WITH 5 HOOKS

16" Rectangular tubing with 5 hooks.

GRID-STORE SLANTED SHELF

Slanted shelf allows you to display products higher up yet still easy to see. Measures 15-1/4" L x 22-3/8" W.

GRID-STORE BASKETS

12" L x 12" W x 8" H baskets, one also available with a 4" front lip allowing easy access to items stored.

MODEL NO.	DESCRIPTION	CTN QTY	CTN WGT
Grid Panels			
A GSP-2448	24" x 48" Grid-Store Panel	1	12 lbs
GSP-2460	24" x 60" Grid-Store Panel	1	15 lbs
GSP-2472	24" x 72" Grid-Store Panel	1	17 lbs
Grid Panels Accessories			
B GSP-HOOK6	6" Grid-Store Hook	1	1 lb
GSP-HOOK8	8" Grid-Store Hook	1	1 lb
GSP-HOOK10	10" Grid-Store Hook	1	1 lb
C GSP-B12128	12" x 12" x 8" Grid-Store Basket	1	3 lbs
D GSP-5HOOK-16	16" Rectangular Tube w/ 5 Hooks	1	2 lbs
E GSP-WMHD	Heavy-Duty Wall Mounting Bracket	1	1 lb
F GSP-SB12128	12" x 12" x 8" Slanted Grid-Store Basket	1	2 lbs
G GSP-SS2215	22-3/8" x 15-1/4" Slanted Shelf	1	4 lbs

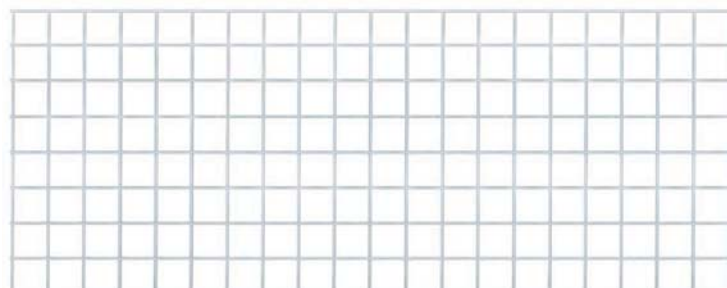
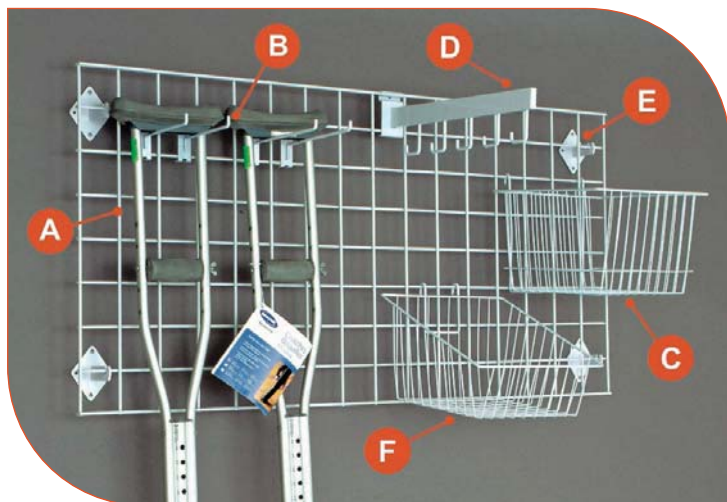

A GSP-2448

Accessories



B GSP-Hooks 6", 8" and 10"



C GSP-B12128



D GSP-5HOOK-16



E GSP-WMHD



F GSP-SB12128

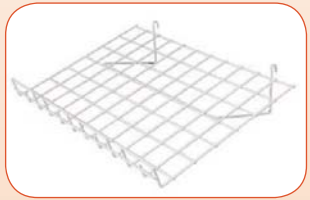

G GSP-SS2215

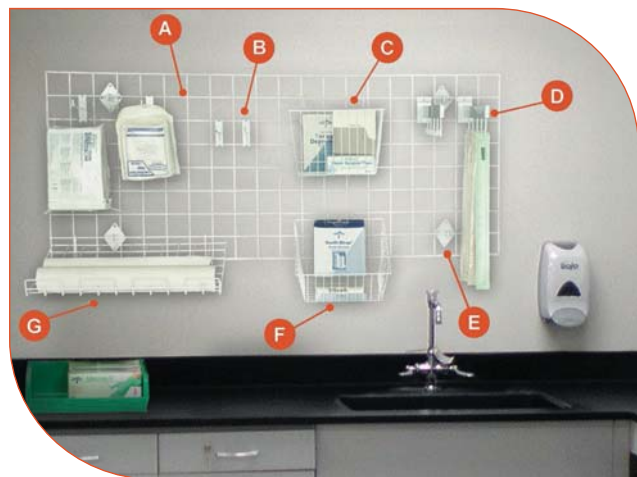

STRONG & VERSATILE SOLUTION FOR SMALL, MEDIUM AND LARGE SUPPLIES

PARTition Wall Systems

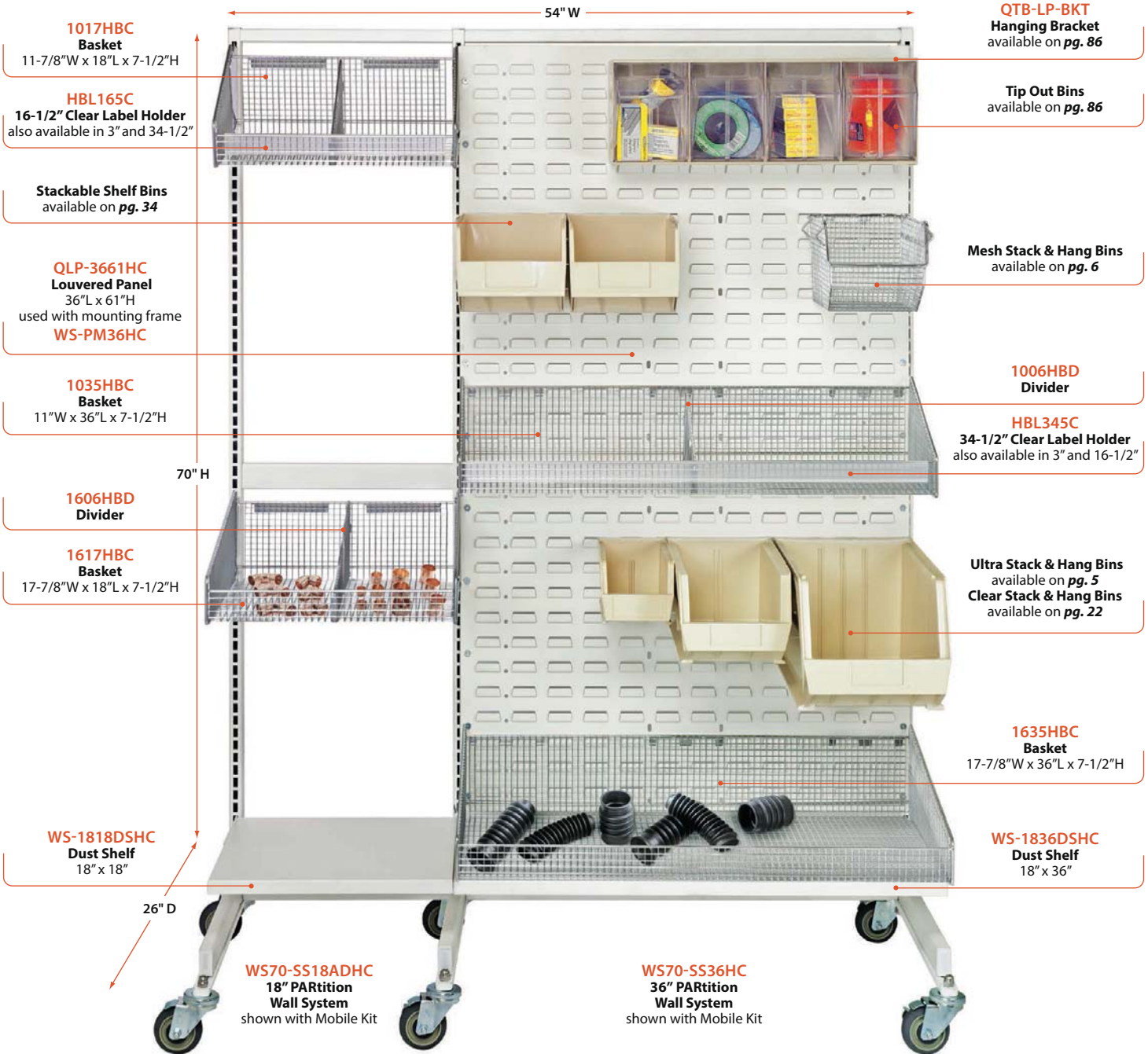

INSTANT VISIBILITY, EASY TO CLEAN, ALL WELDED



QTB-LP-BKT
Hanging Bracket for Tip Out Bins



All Starter and Add-On Units come standard with Leg Levelers



All Starter and Add-On Units can be made mobile

Mobilize your units by ordering the following:

- | | |
|---------------------------------|---------------------------------|
| Single Sided Starter Kit | Double Sided Starter Kit |
| 2 - WS-SSMOB Bar | 2 - WS-DSMOB Bar |
| 2 - WS-MOB Caster Kit | 2 - WS-MOB Caster Kit |
| Single Sided Add-On Kit | Double Sided Add-On Kit |
| 1 - WS-SSMOB Bar | 1 - WS-DSMOB Bar |
| 1 - WS-MOB Caster Kit | 1 - WS-MOB Caster Kit |



LOWEST PRICE GUARANTEED!

Starter Units

Starter units come complete with two uprights and three tie-bars.



Add-On Units

Add-On units allow you to expand your Starter unit by sharing an upright. Add-On unit includes one common upright and three tie-bars.



STARTER UNIT		ADD-ON		ACCESSORIES					
L"	MODEL NO.	SHIP WGT	MODEL NO.	SHIP WGT	HANG BAR	12" DUST SHELF	18" DUST SHELF	LOUVERED PANEL	PANEL FRAME*
L"	MODEL NO.	SHIP WGT	MODEL NO.	SHIP WGT	MODEL NO.	MODEL NO.	MODEL NO.	MODEL NO.	MODEL NO.
Single Side Unit									
18"	WS70-SS18HC	31 lbs	WS70-SS18ADHC	19 lbs	-	WS-1218DSHC	WS-1818DSHC	QLP-1861HC	WS-PM18HC
36"	WS70-SS36HC	37 lbs	WS70-SS36ADHC	25 lbs	WS-HB36HC	WS-1236DSHC	WS-1836DSHC	QLP-3661HC	WS-PM36HC
48"	WS70-SS48HC	42 lbs	WS70-SS48ADHC	30 lbs	WS-HB48HC	WS-1248DSHC	WS-1848DSHC	QLP-4861HC	WS-PM48HC
Double Side Unit									
18"	WS70-DS18HC	34 lbs	WS70-DS18ADHC	21 lbs	-	WS-1218DSHC	WS-1818DSHC	QLP-1861HC	WS-PM18HC
36"	WS70-DS36HC	40 lbs	WS70-DS36ADHC	27 lbs	WS-HB36HC	WS-1236DSHC	WS-1836DSHC	QLP-3661HC	WS-PM36HC
48"	WS70-DS48HC	45 lbs	WS70-DS48ADHC	32 lbs	WS-HB48HC	WS-1248DSHC	WS-1848DSHC	QLP-4861HC	WS-PM48HC

* Required to mount louvered panels

CUSTOMIZE YOUR OWN UNIT

For Units using Hanging Brackets:

1. Determine total space you want to fill from left to right
2. Select a Starter Unit (either 18" or 36" wide)
3. Fill remaining space by utilizing Add-On Units
4. Determine how many basket levels you want to have per unit, which will correspond to the total number of brackets needed
5. Dividers and label holders are available for all basket sizes

For Units using Louvered Panels:

1. Determine total space you want to fill from left to right
2. Select a Starter Unit (either 18", 36" or 48" wide)
3. Fill remaining space by utilizing Add-On Units
4. Each unit (both Starter or Add-On) will fit a corresponding 18", 36" or 48" louvered panel (note: Louvered panel requires one panel frame)
5. Louvered panel will accommodate:
 - **Hanging Baskets** - available on **pg. 117**
 - **Clear Tip Out Bins** - available on **pg. 86** (note: one hanging bracket pair **QTB-LP-BKT** is needed per Tip Out Bin)
 - **Mesh Bins** - available on **pg. 6**
 - **Plastic Bins** - available on **pgs. 5, 22 & 34** (see chart on the bottom of **pg. 9** to determine quantity of bins that fit on panel)

Hanging Baskets

- 125 lb. load capacity per basket (up to twice as strong as plastic bins)
- Mesh design ensures no accumulation of dirt or dust and instant visibility
- Brilliant chrome finish ensures professional appearance and years of heavy-duty service
- Baskets can be divided allowing maximization of all space

MODEL NO.	OUTSIDE DIMENSIONS W" x L" x H"	INSIDE DIMENSIONS W" x L" x H"	SHIP WGT
Hanging Baskets			
1017HBC	11-7/8" x 18" x 7-1/2"	11" x 17-3/8" x 7"	5 lbs
1035HBC	11-7/8" x 36" x 7-1/2"	11" x 35" x 7"	9 lbs
1617HBC	17-7/8" x 18" x 7-1/2"	17" x 17-3/8" x 7"	6 lbs
1635HBC	17-7/8" x 36" x 7-1/2"	17" x 35" x 7"	11 lbs

UNIQUELY DESIGNED FOR HIGH VISIBILITY & EASY ACCESS



FIRST POSITION
Flat



SECOND POSITION
10° slope



THIRD POSITION
30° slope



ADJUSTABLE BRACKETS ALLOW YOU TO CHOOSE YOUR IDEAL POSITION & EASIEST ACCESS TO STORED PRODUCT

COMPLETE PACKAGES WITH BASKETS



DIVIDERS
Basket divider allows you to quickly and easily organize the contents of your basket unit by creating separate compartments within each basket
(Sold separately)



WS70-SS36-4S3L
Shown with dividers
(Sold separately)

PARTition Wall Systems - Complete Packages

NEW

PARTition Wall Hanging Baskets are uniquely designed for instant visibility and easy access while maximizing your storage area. The wire construction minimizes dirt accumulation and allows air circulation. Baskets have a 1/2" x 1/2" grid pattern to partition product while letting you know when to reorder product and restock items. Available in 11-7/8" and 17-7/8" widths, and in 18" and 36" lengths. **Finish:** Chrome

STARTER UNIT		ADD-ON		BASKET		ACCESSORIES		
MODEL NO.	SHIP WGT	MODEL NO.	SHIP WGT	MODEL NO.	NO. OF BASKETS	DIVIDER	LABEL HOLDERS	DUST SHELF
18" Single Sided Systems - Complete with Baskets								
WS70-SS18-7S	83 lbs	WS70-SS18AD-7S	71 lbs	1017HBC	7	1006DHB	HBL165C	WS-1218DSHC
WS70-SS18-4S3L	86 lbs	WS70-SS18AD-4S3L	74 lbs	1017HBC	4	1006DHB	HBL165C	WS-1818DSHC
				1617HBC	3	1606DHB	HBL165C	
36" Single Sided Systems - Complete with Baskets								
WS70-SS36-7S	117 lbs	WS70-SS36AD-7S	105 lbs	1035HBC	7	1006DHB	HBL345C	WS-1236DSHC
WS70-SS36-4S3L	123 lbs	WS70-SS36AD-4S3L	111 lbs	1035HBC	4	1006DHB	HBL345C	WS-1836DSHC
				1635HBC	3	1606DHB	HBL345C	



Dividers

2 SIZES AVAILABLE

Separate product in basket with use of optional dividers. Dividers are used front to back to create individual compartments.

MODEL NO.	DIMENSIONS W" x H"	SHIP WGT
Hanging Basket Dividers		
1006DHB	10" x 6"	1 lb
1606DHB	16" x 6"	2 lbs



Clear Label Holders

A user friendly method for identifying product. Affixes directly to the front on any basket. Three lengths available.

MODEL NO.	DESCRIPTION	SHIP WGT
Clear Label Holders		
HBL3C	3" Clear Label Holder	1 lb
HBL165C	16-1/2" Clear Label Holder	1 lb
HBL345C	34-1/2" Clear Label Holder	1 lb



HBL165C



WS-1218DSHC

Dust Shelves

MODEL NO.	DIMENSIONS W" x L"	SHIP WGT
Dust Shelves		
WS-1218DSHC	12" x 18"	5 lbs
WS-1236DSHC	12" x 36"	10 lbs
WS-1248DSHC	12" x 48"	15 lbs
WS-1818DSHC	18" x 18"	7 lbs
WS-1836DSHC	18" x 36"	15 lbs
WS-1848DSHC	18" x 48"	20 lbs

* Dust Shelves not designed for load bearing

Spikes and Holders

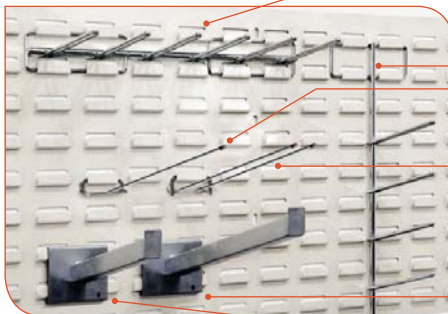

WS-HTH
Horizontal Tape/Reel Holder
25 lb. load capacity

WS-VTH
Vertical Tape/Reel Holder
25 lb. load capacity

WS-SR9C
9" Single Rod
15 lb. load capacity

WS-DR10C
10" Double Rod
15 lb. load capacity

WS-HDS12
Heavy-Duty 12" Spike
50 lb. load capacity

WS-HDS6
Heavy-Duty 6" Spike
65 lb. load capacity



WS-HBB

WS-HBBA



WS-HBB-D

WS-HBBA-D

Louvered Panels

MODEL NO.	DIMENSIONS L" x H"	SHIP WGT
Oyster White Louvered Panels		
QLP-1861HC	18" x 61"	21 lbs
QLP-3661HC	36" x 61"	40 lbs
QLP-4861HC	48" x 61"	60 lbs

* Louvered Panels require panel frame in order to affix to PARTITION Wall Systems



WS-HB36HC

Hang Bars

Used to mount wire louvered panels on PARTITION Wall Systems. Wire Panels available on [pg. 7](#)

MODEL NO.	DESCRIPTION	SHIP WGT
Hang Bars		
WS-HB36HC	36" Hang Bar	4 lbs
WS-HB48HC	48" Hang Bar	5 lbs



QLP-4861HC



QLP-3661HC



QLP-1861HC



Cantilever Single Shelf Wall Mount

Cantilever shelving is an excellent way to create storage space when floor space isn't available. Simple in design, our cantilever shelving systems are easy to assemble and install. Select from three different depths: 14", 18" or 24". Two cantilever arms and 2 mounting brackets are included per order. Chrome wire shelves are sold separately and are available on **pg. 104**.

MODEL NO.	DESCRIPTION	SHIP WGT
DWB14	2 - 14" cantilever arms & 2 mounting brackets	3 lbs
DWB18	2 - 18" cantilever arms & 2 mounting brackets	4 lbs
DWB24	2 - 24" cantilever arms & 2 mounting brackets	5 lbs



MOUNTING BRACKET

DWB14, DWB18 or DWB24 Wire Cantilever Arm

Cantilever Multiple Shelf Post Wall Mount Adjustable on 1" increments

Adjustable post wall mount systems use a post cantilever single arm of 14", 18" or 24" with appropriate shelf size and post height. Two post cantilever single arms and 4 post mount brackets are included per order.

Post Cantilever Double Arm is available in 14", 18" and 24" and uses the center post for continuous or add-on shelf sections. One post cantilever double arm and 2 post mount brackets are included per order. Wire shelves and post are sold separately and available on **pgs. 104 & 105**.

MODEL NO.	DESCRIPTION	SHIP WGT
Single Post Cantilever Arms		
CB14	2 - 14" single post cantilever arms & 4 post mount brackets	5 lbs
CB18	2 - 18" single post cantilever arms & 4 post mount brackets	6 lbs
CB24	2 - 24" single post cantilever arms & 4 post mount brackets	7 lbs
Double Post Cantilever Arms		
DCB14	1 - 14" double post cantilever arm & 2 post mount brackets	10 lbs
DCB18	1 - 18" double post cantilever arm & 2 post mount brackets	12 lbs
DCB24	1 - 24" double post cantilever arm & 2 post mount brackets	14 lbs

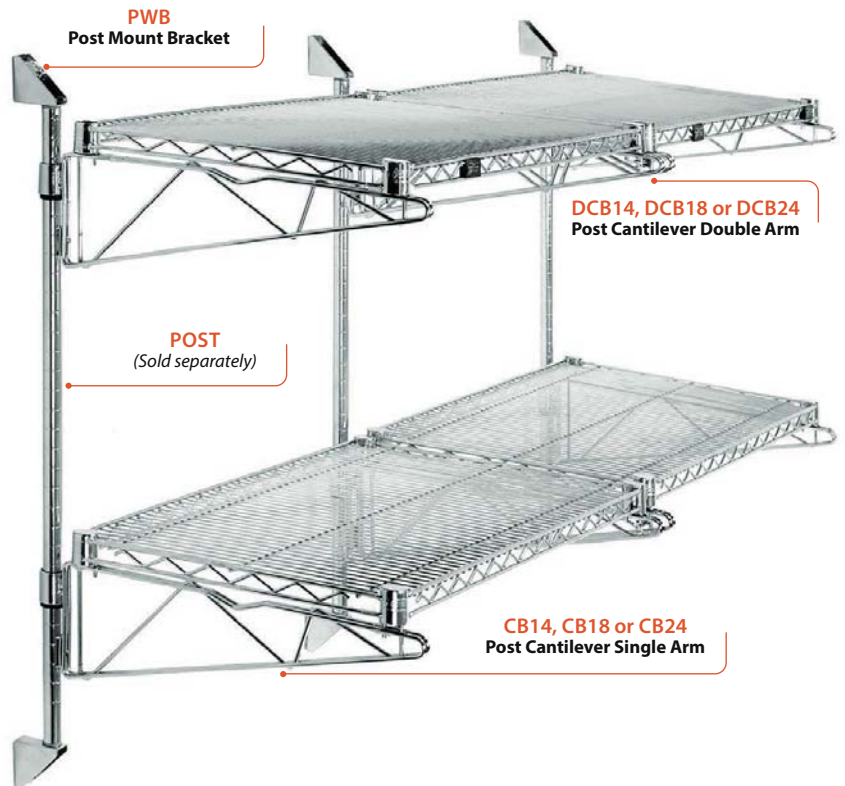

PWB Post Mount Bracket
Used to secure cantilever post mount units and free standing shelving units to wall.
Sold in a pack of 4.
(Mounting Screws are not included)

TO ORDER THIS EXACT CONFIGURATION, YOU WOULD ORDER THE FOLLOWING:

- 2 - CB18
- 2 - DCB18
- 4 - 1836C
- 3 - P34C

To further extend the configuration shown by an additional section to the left or right, simply order:

- 2 - DCB18
- 2 - 1836C
- 1 - P34C

To further extend the configuration shown by an additional shelf level, simply order:

- 1 - CB18
- 1 - DCB18
- 2 - 1836C

Your options are unlimited.



LOWEST PRICE GUARANTEED!

**Post Wall Mount Cantilever with Bin Holders
Complete Packages**

Easy access, adjustable wall mounted bin systems. Available in 36", 48" and 60" widths. Optional bin dividers, windows fronts and clear label holders are available on **pg. 5**.

MODEL NO.	NO. OF BIN HOLDERS	DIMENSIONS L" x H"	NO. OF BINS	BIN DIMENSIONS L" x W" x H"	SHIP WGT
Wire Cantilever Bin Holder -- Complete with Bins Available in Blue, Green, Ivory, Red, Yellow, Black and Clear					
CAN-34-36BH-230	3	36" x 34"	18 QUS230	10-7/8" x 5-1/2" x 5"	26 lbs
CAN-34-48BH-230	3	48" x 34"	24 QUS230	10-7/8" x 5-1/2" x 5"	34 lbs
CAN-34-60BH-230	3	60" x 34"	30 QUS230	10-7/8" x 5-1/2" x 5"	42 lbs

COMPLETE PACKAGES WITH BINS



CAN-34-36BH-230



CAN-34-60BH-230

**Post Wall Mount Cantilever with Baskets
Complete Packages**

Modular Wire Baskets mount to standard post to utilize wall space efficiently. Baskets allow for high visibility and quick accessibility. Baskets are adjustable and removable. **Finish:** Chrome

MODEL NO.	NO. OF BASKETS	BASKET MODEL NO.	BASKET DIMENSIONS W" x L" x H"	SHIP WGT
34"H Wire Cantilever with Baskets -- Complete Packages				
CAN-34-1436BC-PWB	2	1436BC	14" x 36" x 9"	26 lbs
CAN-34-1448BC-PWB	2	1448BC	14" x 48" x 9"	32 lbs
CAN-34-2036BC-PWB	2	2036BC	20" x 36" x 9"	30 lbs
CAN-34-2048BC-PWB	2	2048BC	20" x 48" x 9"	36 lbs
CAN-34-203612BC-PWB	2	203612BC	20" x 36" x 12"	34 lbs
CAN-34-204812BC-PWB	2	204812BC	20" x 48" x 12"	38 lbs

COMPLETE PACKAGES WITH BASKETS



CAN-34-1436BC-PWB

Basket Dividers

Optional dividers can be used to separate product. **Finish:** Chrome

DIVIDER MODEL NO.	DIMENSIONS L" x H"	SHIP WGT
149DC	14" x 9"	1 lb
209DC	20" x 9"	2 lbs
2012DC	20" x 12"	2 lbs



149DC
Shown on Basket

Modular Wire Stacking Baskets

Offer a variety of storage, display and mobile supply applications. Dividers can be used to separate product. Accessible front and a wide selection of sizes allow for all types of product to be used from storage to display. (Dividers sold separately) **Finish:** Chrome



1436BC
Shown with Dividers and Clear Label Holder (Sold separately)

CLEAR LABEL HOLDERS
A user friendly method for identifying product. Affix directly to the front on any basket. Available in three lengths. (Sold separately)

MODEL NO.	DESCRIPTION	SHIP WGT
Clear Label Holders		
BLH3C	3" Clear Label Holder	1 lb
BLH14C	14" Clear Label Holder	1 lb
BLH32C	32" Clear Label Holder	1 lb

MODEL NO.	BASKET DIMENSIONS W" x L" x H"	SHIP WGT	DIVIDER MODEL NO.	SHIP WGT
1436BC	14" x 36" x 9"	10 lbs	149DC	1 lb
1448BC	14" x 48" x 9"	13 lbs	149DC	1 lb
2036BC	20" x 36" x 9"	12 lbs	209DC	2 lbs
2048BC	20" x 48" x 9"	15 lbs	209DC	2 lbs
203612BC	20" x 36" x 12"	14 lbs	2012DC	2 lbs
204812BC	20" x 48" x 12"	16 lbs	2012DC	2 lbs

FOR ALL TYPES OF PRODUCTS



WR5-36MSBA



WR5-36MSBA-MOB

DOLLY BASE

800 lb. LOAD CAPACITY

Build & stack any combination of baskets for your requirements. Larger baskets must be positioned on the lowest point.

Stationary Stacking Baskets

Order this exact unit **WR5-36MSBA**
Unit consists of:
2 - baskets 1436BC
2 - dividers 149DC
3 - baskets 203612BC
3 - dividers 2012DC

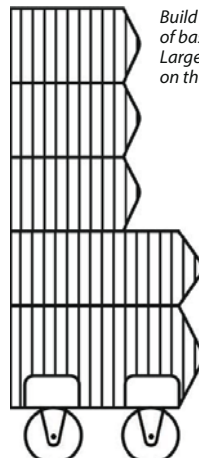

Mobile Stacking Baskets

Order this exact unit **WR5-36MSBA-MOB**
Unit consists of:
2 - baskets 1436BC
2 - dividers 149DC
3 - baskets 203612BC
3 - dividers 2012DC
1 - dolly M2036BD

Dolly Base

Includes 4 - 5" swivel casters which offers easy transport to any unit.

MODEL NO.	DIMENSIONS W" x L"	SHIP WGT
M2036BD	20" x 36"	32 lbs
M2048BD	20" x 48"	34 lbs



LOWEST PRICE GUARANTEED!

3 BASKET POSITIONS FOR FLEXIBLE STORAGE



Angle Down
Flows parts to front provides maximum accessibility



Flat
Provides maximum space efficiency



Angled Up
Provides maximum bin capacity

Wire Basket Units

Basket units allow high visibility and air circulation. The basket acts as a dispensing and storage module which can be added to 18", 21" and 24" deep shelving units. The collar hook allows the basket to be removed or adjusted to accommodate various product mix and sizes. Baskets are adjustable on 1" increments. 110 lb. load capacity per basket. Adjustable baskets used in combination with shelves are an excellent method to store all types of products. Units can be stationary or mobile. Casters add flexibility and convert stationary units into transport systems. Ideal for exchange charts and par level storage. *(Dividers sold separately)* **Finish:** Chrome



M1836BC6C
(Dividers sold separately)



1836BC6C
(Dividers sold separately)



COLLAR HOOKS
Hooks onto basket corner allowing basket to securely hang.

Mobile Wire Basket Units

Each mobile unit consists of:

- 4 - 63"H posts
- 3 - 9"H adjustable baskets including collar hooks
- 2 - wire shelves
- 4 - donut bumpers
- 4 - swivel 5" x 1-1/4" polyurethane casters, 2 with brakes

STATIONARY MODEL NO.	DIMENSIONS W" x L" x H"	NO. OF SHELVES	NO. OF BASKETS	SHIP WGT
M1836BC6C	18" x 36" x 69"	2	3	78 lbs
M1848BC6C	18" x 48" x 69"	2	3	90 lbs
M2436BC6C	24" x 36" x 69"	2	3	93 lbs
M2448BC6C	24" x 48" x 69"	2	3	108 lbs

COMPLETE PACKAGES WITH BASKETS

Stationary Wire Basket Units

Each stationary unit consists of:

- 4 - 63"H posts
- 3 - 9"H adjustable baskets including collar hooks
- 2 - wire shelves

STATIONARY MODEL NO.	DIMENSIONS W" x L" x H"	NO. OF SHELVES	NO. OF BASKETS	SHIP WGT
1836BC6C	18" x 36" x 63"	2	3	70 lbs
1848BC6C	18" x 48" x 63"	2	3	82 lbs
2436BC6C	24" x 36" x 63"	2	3	85 lbs
2448BC6C	24" x 48" x 63"	2	3	100 lbs

Post Baskets

NEW

HIGH VISIBILITY, EASY TO CLEAN, ALL-WELDED

Quantum's new post baskets are manufactured of industrial grade chrome wire offering a 5/8" x 5/8" mesh design on the bottom/flat surface. Super heavy-duty design affords a generous 600-800 lb. load capacity* evenly distributed. Unique design allows baskets to be used WITHOUT needing any flat shelves to stabilize overall unit. Drop front and sloped sides provide super easy access while providing a captive space for stored items. Baskets are all adjustable on 1" increments utilizing standard 1" diameter posts. **Finish:** Chrome



BSK1836C

Basket shown with Blue Hanging Label Tag PS-LH3

Available in:

- Clear
 - Red
 - Yellow
 - Blue
 - Green
- (Sold separately)

MODEL NO.	DIMENSIONS W" x L" x H"	SHIP WGT	DIVIDER MODEL NO.	SHIP WGT
BSK1824C	18" x 24" x 10"	11 lbs	DSK18	2 lbs
BSK1836C	18" x 36" x 10"	13 lbs	DSK18	2 lbs
BSK1848C	18" x 48" x 10"	17 lbs	DSK18	2 lbs
BSK1860C	18" x 60" x 10"	27 lbs	DSK18	2 lbs
BSK2424C	24" x 24" x 10"	12 lbs	DSK24	3 lbs
BSK2436C	24" x 36" x 10"	15 lbs	DSK24	3 lbs
BSK2448C	24" x 48" x 10"	20 lbs	DSK24	3 lbs
BSK2460C	24" x 60" x 10"	34 lbs	DSK24	3 lbs

* 24" - 48" wide offer 800 lb. capacity evenly distributed 60" wide offers 600 lb. capacity evenly distributed

Clear Label Holders

A user friendly method for identifying product. Affixes directly to the front on any post basket. Available in six lengths. (Label inserts sold separately)

MODEL NO.	DESCRIPTION	SHIP WGT
	Clear Label Holders	
BLH3C	3" Clear Label Holder	1 lb
BLH14C	14" Clear Label Holder	1 lb
BLH20C	20" Clear Label Holder	1 lb
BLH32C	32" Clear Label Holder	1 lb
BLH44C	44" Clear Label Holder	1 lb
BLH56C	56" Clear Label Holder	1 lb

**COMPLETE CARTS
INCLUDE
CASTER KIT FOR
MOBILITY**



DIVIDERS

Post basket divider allows you to quickly and easily organize the contents of your post basket unit by creating separate compartments within each basket (Sold separately)

Mobile 5 Post Basket Units

NEW

Each mobile unit consists of:

- 4 - 74"H posts
- 5 - post basket
- 4 - donut bumpers
- 4 - 5" x 1-1/4" swivel polyurethane casters, 2 with brake

MODEL NO.	DIMENSIONS W" x L" x H"	SHIP WGT
WRC74-BSK1824C-5	18" x 24" x 80"	94 lbs
WRC74-BSK1836C-5	18" x 36" x 80"	127 lbs
WRC74-BSK1848C-5	18" x 48" x 80"	160 lbs
WRC74-BSK1860C-5	18" x 60" x 80"	197 lbs
WRC74-BSK2424C-5	24" x 24" x 80"	125 lbs
WRC74-BSK2436C-5	24" x 36" x 80"	158 lbs
WRC74-BSK2448C-5	24" x 48" x 80"	191 lbs
WRC74-BSK2460C-5	24" x 60" x 80"	228 lbs



WRC74-BSK1836C-5



LOWEST PRICE GUARANTEED!

Hanging Label Tags

Hanging label tag accommodates 1-3/8" x 3" adhesive labels. Label tags work with all wire shelves, mesh bins, hanging, stacking and post baskets. Available in 5 colors. Package of 25.



5 COLORS AVAILABLE



PS-LH3
Hanging Label Tag
Fits 1-3/8" x 3" Adhesive Label

EASILY IDENTIFY PRODUCT ON ANY SIZE SHELF

Shelf Label Holders

Are an excellent method for identifying product. Holders affix directly to truss on any size shelf. (Label inserts sold separately)

MODEL NO.	DESCRIPTION	SHIP WGT
LH3B	3" Gray Label Holder	1 lb
LH3C	3" Clear Label Holder	1 lb
LH12C	12" Clear Label Holder	1 lb
LH24C	24" Clear Label Holder	1 lb
Full Length Label Holders		
LH33C	33" Clear Label Holder Fits 36" Shelf	1 lb
LH39C	39" Clear Label Holder Fits 42" Shelf	1 lb
LH45C	45" Clear Label Holder Fits 40" Shelf	1 lb
LH51C	51" Clear Label Holder Fits 54" Shelf	2 lbs
LH57C	57" Clear Label Holder Fits 60" Shelf	2 lbs
LH69C	69" Clear Label Holder Fits 72" Shelf	2 lbs
Angled Label Holders - 30°, 60° and 90°		
LHA3C	3" Angled Clear Label Holder	1 lb
LHA5C	5" Angled Clear Label Holder	1 lb
LHA24C	24" Angled Clear Label Holder	1 lb



LH3C and LH3B Front Shelf View



LHA3C Bottom Shelf View



LHA3C Top Shelf View

Stacking & Post Basket Clear Label Holders

A user friendly method for identifying product. Affixes directly to the front on any stacking and post basket. Available in six lengths. (Label inserts sold separately)

MODEL NO.	DESCRIPTION	SHIP WGT
Clear Label Holders		
BLH3C	3" Clear Label Holder	1 lb
BLH14C	14" Clear Label Holder	1 lb
BLH20C	20" Clear Label Holder	1 lb
BLH32C	32" Clear Label Holder	1 lb
BLH44C	44" Clear Label Holder	1 lb
BLH56C	56" Clear Label Holder	1 lb

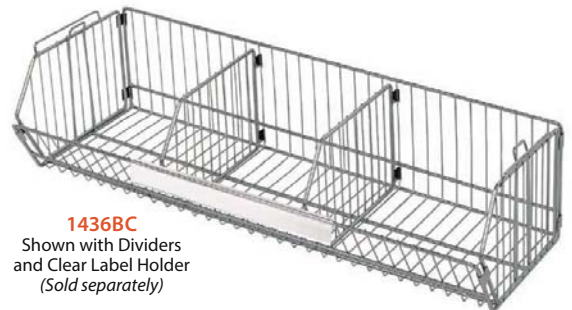

1436BC
Shown with Dividers and Clear Label Holder
(Sold separately)

Laser & Inkjet Label Inserts

Laser and inkjet compatible inserts come in 8-1/2" x 11" perforated sheets. Available in 3" and 6" lengths. Multiple inserts can be used on longer label holders. Package of 48 labels.

MODEL NO.	DESCRIPTION	SHIP WGT
Laser & Inkjet Label Inserts - 48 Labels		
LHI-3	1-1/4" x 3" Inserts (3 Sheets)	1 lb
LHI-6	1-1/4" x 6" Inserts (6 Sheets)	1 lb



Inserts slide into label holders easily

NEED A LARGER SURFACE AREA FOR IDENTIFICATION?

Clear label holder extender with inserts converts 1-1/4"H labels shown above into a 3" x 5" label. Labels can be easily changed or relocated. Laser and inkjet compatible inserts come in 8-1/2" x 11" perforated sheets. Package of 12.



LHE3X5C Label holder extender requires clear label holders listed above. Works with all sizes.

Hanging Basket Clear Label Holders

A user friendly method for identifying product. Affixes directly to the front on any hanging basket. Available in three lengths. (Label inserts sold separately)

MODEL NO.	DESCRIPTION	SHIP WGT
Clear Label Holders		
HBL3C	3" Clear Label Holder	1 lb
HBL165C	16-1/2" Clear Label Holder	1 lb
HBL345C	34-1/2" Clear Label Holder	1 lb

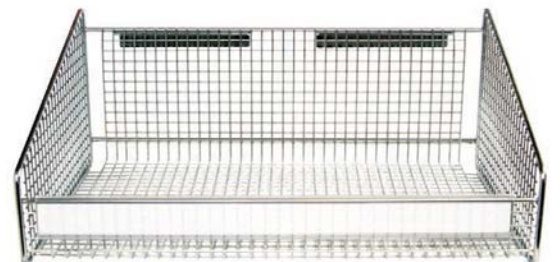

HBL165C

PARtition Store Pull Out Basket Carts

NEW

Pull out basket storage organize and transport your storage tools and needed parts.

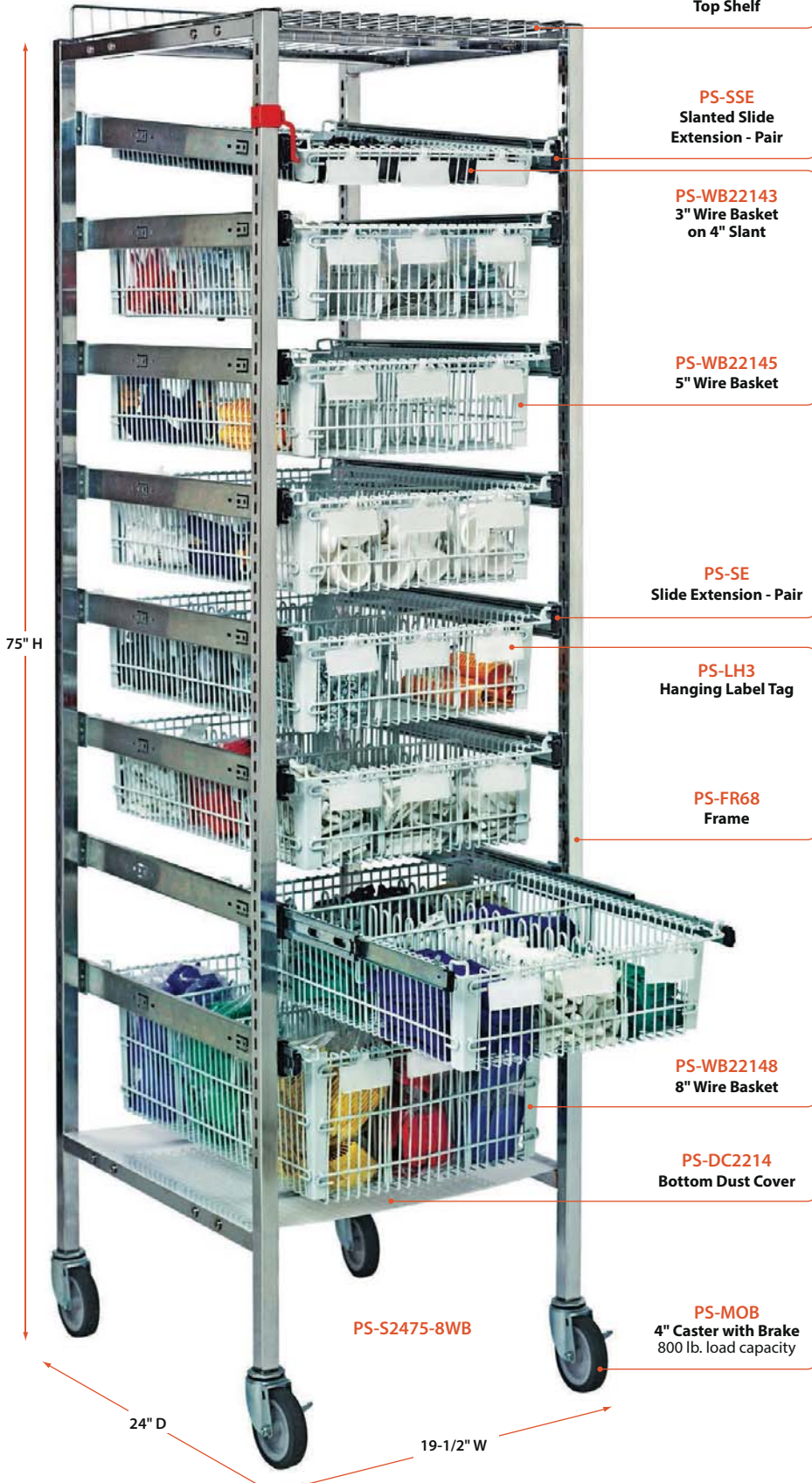

PS-TS22184
Top Shelf

PS-SSE
Slanted Slide
Extension - Pair

PS-WB22143
3" Wire Basket
on 4" Slant

PS-WB22145
5" Wire Basket

PS-SE
Slide Extension - Pair

PS-LH3
Hanging Label Tag

PS-FR68
Frame

PS-WB22148
8" Wire Basket

PS-DC2214
Bottom Dust Cover

PS-S2475-8WB

PS-MOB
4" Caster with Brake
800 lb. load capacity

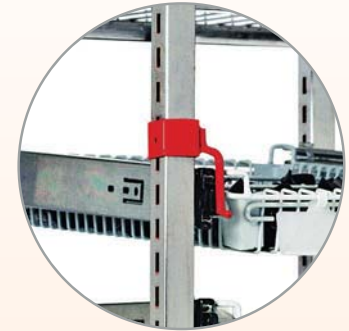

PS-RSS
Red Safety Stop
Used to secure wire baskets from sliding out when used on slanted slide.



PS-LH3
Hanging Label Tag
● Clear ● Red ● Yellow ● Blue ● Green
Fits 1-3/8"H x 3"W adhesive label.
Package of 25.
(Sold separately)

QUANTUM IS YOUR STORAGE SOLUTION



LOWEST PRICE GUARANTEED!

PARtition Store Starter Unit

NEW

Starter units come complete with 2 frames, 4 cross bars, top wire shelf, full extension slides, bottom dust cover and four 4"H casters, 2 with brakes.



PS-S2475-8WB

Starter Unit with Wire Baskets
24"D x 19-1/2"W x 75"H

- 1 - 3" wire basket with 2 long & 2 short-dividers
- 6 - 5" wire baskets with 2 long & 2 short-dividers
- 1 - 8" wire basket with 2 long & 2 short-divider
- 1 - safety stop
- 1 - bottom dust cover
- 25 - PS-LH3 Clear hanging label tags



PS-S2475-8PT

Starter Unit with Plastic Mesh Baskets
24"D x 19-1/2"W x 75"H

- 7 - 4" plastic baskets with 1 Long & 2 Short-Dividers
- 1 - 8" plastic baskets with 1 Long & 1 Short-Divider
- 1 - safety stop
- 1 - bottom dust cover



PS-S2475-7S

Starter Unit with Wire Shelves
24"D x 19-1/2"W x 75"H

- 7 - wire shelves on slides
- 1 - bottom dust cover
- 25 - PS-LH3 Clear hanging label tags

PARtition Store Add-On Unit

800 lb. LOAD CAPACITY

Add-on units come complete with 1 frames, 4 cross bars, top wire shelf, full extension slides, bottom dust cover and two 4"H casters, 1 with brake.

EXPAND YOUR STARTER UNIT WITH AN ADD-ON UNIT



PS-A2475-8WB

Add-on with Wire Baskets



PS-A2475-8PT

Add-on with Plastic Mesh Baskets



PS-A2475-7S

Add-on with Wire Shelves

PARTition Store Single Bay Carts

NEW

- Designed for transport of tools and needed parts
- All-welded 1" square tubular epoxy-coated steel frame
- Sturdy base with solid shelf

HEAVY-DUTY PULL OUT BASKET TRANSPORT CARTS



PS-SBC58-6WB

29-1/2"D x 25"W x 58-1/2"H

- 1 - 3" wire basket with 2 long & 2 short dividers
- 4 - 5" wire baskets with 2 long & 2 short dividers
- 1 - 8" wire basket with 2 long & 2 short dividers
- 25 - PS-LH3 Clear hanging label tags

PS-SBC58-6PT

29-1/2"D x 25"W x 58-1/2"H

- 5 - 4" plastic baskets
- 1 - 8" plastic baskets

PS-SBC58-6S

29-1/2"D x 25"W x 58-1/2"H

- 6 - wire shelves
- 25 - PS-LH3 Clear hanging label tags

1,200 lb.
LOAD CAPACITY

FULL CAPACITY COMPARTMENTS



PS-SBC58-6WB
Wire Basket



PS-SBC58-6PT
Plastic Mesh Baskets

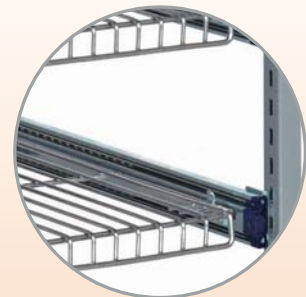

PS-SBC58-6S
Wire Shelves



LOWEST PRICE GUARANTEED!

DOUBLE BAY HEAVY-DUTY PULL OUT BASKET TRANSPORT CARTS



PS-DBC-14PT
Cart with Plastic Mesh Baskets
29-1/2"D x 44"W x 74-1/2"H
14 - 4" plastic baskets



PS-DBC-7WB7S
Cart with Wire Baskets & Shelves
29-1/2"D x 44"W x 74-1/2"H
7 - 5" wire baskets with 2 long & 2 short dividers
7 - wire shelves on slides
50 - PS-LH3 Clear hanging label tags

PARTition Store Double Bay Carts

NEW

- Designed for transport of tools and needed parts
- All-welded 1-1/2" square tubular epoxy-coated steel frame
- Sturdy base with solid shelf insert
- 5" quiet poly swivel casters
- Standard donut bumpers on corners which protect walls and provide cushion impact
- Accessories include dividers and label holders
- Custom configurations are available, call a product specialist for details

1,200 lb. LOAD CAPACITY

Also available:
PS-DBC-14WB
Cart with Wire Baskets
29-1/2"D x 44"W x 74-1/2"H
14 - 5" wire baskets with 2 long & 2 short dividers
50 - PS-LH3 Clear hanging label tags

PS-DBC-14S
Cart with Wire Shelves
29-1/2"D x 44"W x 74-1/2"H
14 - wire shelves on slides
50 - PS-LH3 Clear hanging label tags

Accessories

Wire Options

Plastic Options

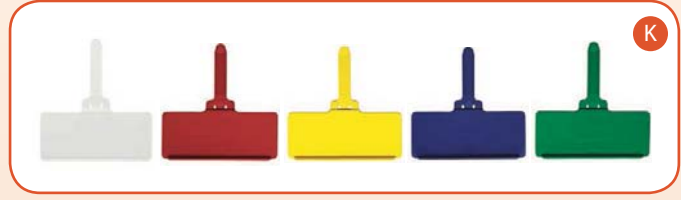
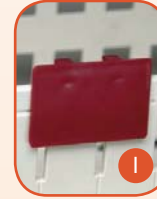
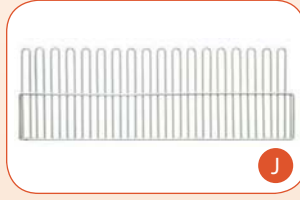
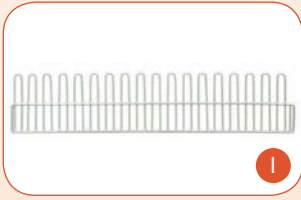

Wire Options

- A **PS-WB22143**
3" Wire Basket
22" x 14" x 3"
- B **PS-WB22145**
5" Wire Basket
22" x 14" x 5"
- C **PS-WB22148**
8" Wire Basket
22" x 14" x 8"
- D **PS-SE**
Slide Extension - Pair
PS-SSE
Slant Slide Extension - Pair
- E **PS-WS2414**
Flat Shelf Available in:
- White
- Chrome
- F **PS-TS22184WT**
White Top Shelf
PS-TS22184C
Chrome Top Shelf

- H **PS-WBLD-3**
3" Basket Long Divider
PS-WBSD-3
3" Basket Short Divider
- I **PS-WBLD-5**
5" Basket Long Divider
PS-WBSD-5
5" Basket Short Divider
- J **PS-WBLD-8**
8" Basket Long Divider
PS-WBSD-8
8" Basket Short Divider

Plastic Options

- A **PS-PT16242**
2" Solid Basket
24" x 16" x 2"
- B **PS-PMT16244**
4" Mesh Basket
24" x 16" x 4"
- C **PS-PT16244**
4" Solid Basket
24" x 16" x 4"
- D **PS-PMT16248**
8" Mesh Basket
24" x 16" x 8"
- E **PS-DC2214**
Bottom Dust Cover
22" x 14"
- F **PS-PLD2**
2" Tray Long Divider
PS-PSD2
2" Tray Short Divider
PS-PLD4
4" Tray Long Divider

- PS-PSD4**
4" Tray Short Divider
- PS-PLD8**
8" Tray Long Divider
- PS-PSD8**
8" Tray Short Divider
- G **PS-PTS**
Tray Stop
- H **PS-PDH**
Divider Holder
- I **PS-PLH**
Label Holder
- J **PS-PDL**
Divider Lock
- K **PS-LH3**
1-3/8" x 3"
Hanging Label Tag
Available in:
- Clear - Red - Yellow
- Blue - Green

WIRE AND PLASTIC
OPTIONS AVAILABLE



LOWEST PRICE GUARANTEED!



1836DS

ENDURANCE MODEL NO.	DIMENSIONS W" x L"	SHIP WGT
1836DS	18" x 36"	21 lbs
1848DS	18" x 48"	28 lbs
1860DS	18" x 60"	34 lbs
2436DS	24" x 36"	24 lbs
2448DS	24" x 48"	30 lbs
2460DS	24" x 60"	37 lbs

Dunnage Shelves



Utilized in extreme load applications. Shelves are constructed of square tubing and a removable top wire grid. 1,500 lb. load capacity. **Finish:** Blue Endurance - Excellent for high humidity or corrosive applications and is fortified with an anti-bacterial agent.

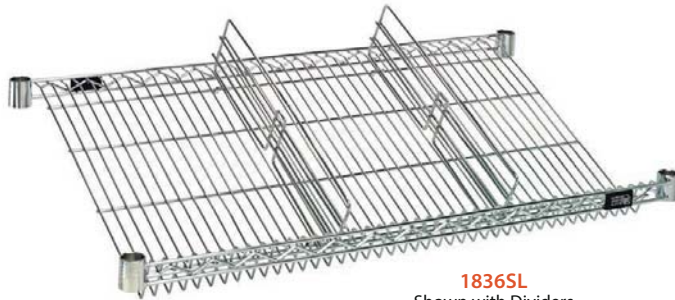

1836SL
Shown with Dividers
(Dividers are sold separately)

CHROME MODEL NO.	DIMENSIONS W" x L"	SHIP WGT	DIVIDER MODEL NO.
1836SL	18" x 36"	10 lbs	DIV18SL
1848SL	18" x 48"	14 lbs	DIV18SL
2436SL	24" x 36"	13 lbs	DIV24SL
2448SL	24" x 48"	16 lbs	DIV24SL

Slanted Shelves



Designed with a 26° slant to add structure to various applications and retain products. Perfect angle for gravity flow as well as bin storage. **Finish:** Chrome



1836FE



1836FC

ENDURANCE MODEL NO.	CHROME MODEL NO.	DIMENSIONS W" x L"	SHIP WGT
1836FE	1836FC	18" x 36"	7 lbs
1848FE	1848FC	18" x 48"	8 lbs
1860FE	1860FC	18" x 60"	9 lbs
2436FE	2436FC	24" x 36"	8 lbs
2448FE	2448FC	24" x 48"	9 lbs
2460FE	2460FC	24" x 60"	10 lbs

Tubular 3 Sided Frames



Constructed of 1" square tubing, frame is designed for added structure to the perimeter of a dunnage or shelving unit. **Finishes:** Blue Endurance & Chrome



1836FS

STAINLESS MODEL NO.	DIMENSIONS W" x L"	SHIP WGT
1836FS	18" x 36"	6 lbs
1848FS	18" x 48"	7 lbs
1860FS	18" x 60"	8 lbs
2436FS	24" x 36"	8 lbs
2448FS	24" x 48"	9 lbs
2460FS	24" x 60"	10 lbs

Stainless Steel 3 Sided Frames



Designed to add structure to various applications and retain products. **Finish:** 304 Stainless Steel

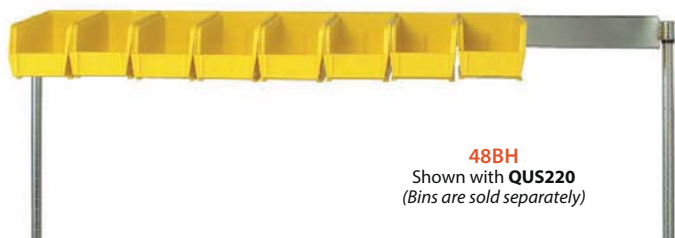

48BH
Shown with QUS220
(Bins are sold separately)

MODEL NO.	DESCRIPTION	SHIP WGT
36BH	One 36" Bin Holder	5 lbs
48BH	One 48" Bin Holder	7 lbs
60BH	One 60" Bin Holder	9 lbs

Bin Rail Holders



Creates a more functional work area with the bin rail which allows you to adapt bins to your shelving unit. Bin rail holder adjusts on 1" increments. **Finish:** Chrome

Mobile Dunnage Platform Racks



With 5" Poly non-marking stem casters add flexibility. Units can be used for moving case goods and other heavy items for cleaning, warehouse and stock room applications. **Finish:** Blue Endurance

Each unit consists of:

- 4 - 6" posts
- 1 - 3 sided frame
- 1 - dunnage shelf
- 4 - 5" swivel poly stem casters, 2 with brakes
- 4 - donut bumpers

ENDURANCE MODEL NO.	DIMENSIONS W" x L" x H"	SHIP WGT
M18366DE	18" x 36" x 12"	36 lbs
M18486DE	18" x 48" x 12"	44 lbs
M18606DE	18" x 60" x 12"	51 lbs
M24366DE	24" x 36" x 12"	40 lbs
M24486DE	24" x 48" x 12"	47 lbs
M24606DE	24" x 60" x 12"	55 lbs



M18366DE

Modular Dunnage Racks



Ideal for extreme load capacities (1,500 lb.). Includes tubular 1" square frame super structure and removable wire top mat. **Finish:** Blue Endurance

Each unit consists of:

- 4 - 14" posts
- 1 - 3 sided frame
- 1 - dunnage shelf

ENDURANCE MODEL NO.	DIMENSIONS W" x L" x H"	SHIP WGT
183614DE	18" x 36" x 14"	28 lbs
184814DE	18" x 48" x 14"	36 lbs
186014DE	18" x 60" x 14"	43 lbs
243614DE	24" x 36" x 14"	32 lbs
244814DE	24" x 48" x 14"	39 lbs
246014DE	24" x 60" x 14"	47 lbs



183614DE

Tank & Beverage Container Racks



Represents a cost effective way to keep containers off the floor for cleanliness. This unit is an effective way to tidy up and increase available storage capacity. Used frequently in cafeterias and warehouse applications. **Finish:** Blue Endurance

Each 1 Tier unit consists of:

- 4 - 34" posts
- 1 - 3 sided frame
- 1 - dunnage shelf

Each 2 Tier unit consists of:

- 4 - 54" posts
- 2 - 3 sided frames
- 2 - dunnage shelves

ENDURANCE MODEL NO.	DIMENSIONS W" x L" x H"	SHIP WGT
1 Tier		
183634DE	18" x 36" x 34"	40 lbs
184834DE	18" x 48" x 34"	48 lbs
186034DE	18" x 60" x 34"	55 lbs
243634DE	24" x 36" x 34"	44 lbs
244834DE	24" x 48" x 34"	51 lbs
246034DE	24" x 60" x 34"	59 lbs
2 Tier		
183654DE	18" x 36" x 54"	68 lbs
184854DE	18" x 48" x 54"	84 lbs
186054DE	18" x 60" x 54"	98 lbs
243654DE	24" x 36" x 54"	76 lbs
244854DE	24" x 48" x 54"	90 lbs
246054DE	24" x 60" x 54"	106 lbs



183654DE

Shelf Platform Racks



Represents an ergonomic solution for keeping case goods off the floor. Platforms are often used at workstations and prep storage areas. **Finish:** Chrome

Each unit consists of:

- 4 - 14" posts
- 1 - shelf

CHROME MODEL NO.	DIMENSIONS W" x L" x H"	SHIP WGT
183614PC	18" x 36" x 14"	14 lbs
184814PC	18" x 48" x 14"	18 lbs
186014PC	18" x 60" x 14"	21 lbs
243614PC	24" x 36" x 14"	17 lbs
244814PC	24" x 48" x 14"	20 lbs
246014PC	24" x 60" x 14"	25 lbs



183614PC



LOWEST PRICE GUARANTEED!

NEW



662412DPP

NEW



662412DPS

MODEL NO.	DIMENSIONS W" x L" x H"	LOAD CAPACITY	SHIP WGT
Ventilated Top			
362412DPP	24" x 36" x 12"	500 lbs	13 lbs
363612DPP	36" x 36" x 12"	750 lbs	22 lbs
482412DPP	24" x 48" x 12"	700 lbs	19 lbs
662412DPP	24" x 66" x 12"	1,000 lbs	23 lbs
663612DPP	36" x 66" x 12"	1,500 lbs	37 lbs
962412DPP	24" x 96" x 12"	1,400 lbs	34 lbs
963612DPP	36" x 96" x 12"	2,000 lbs	53 lbs
Solid Top			
362412DPS	24" x 36" x 12"	700 lbs	17 lbs
363612DPS	36" x 36" x 12"	1,000 lbs	26 lbs
482412DPS	24" x 48" x 12"	900 lbs	21 lbs
662412DPS	24" x 66" x 12"	1,400 lbs	28 lbs
663612DPS	36" x 66" x 12"	1,900 lbs	49 lbs
962412DPS	24" x 96" x 12"	1,800 lbs	41 lbs
963612DPS	36" x 96" x 12"	2,700 lbs	64 lbs

Polymer Dunnage Racks



Our Dunnage Racks are as portable as they are versatile. Made from lightweight, heavy-duty high density polyethylene, these are the perfect match for wet or chemically intense manufacturing environments. A simple snap together design makes it a breeze to raise finished goods and raw materials off the ground and away from moisture, dirt and traffic. When it comes to cleanup time, just sweep underneath! We offer the largest commercially available sizes in a high-capacity, low-cost dunnage solution that lets you reset and move workstations as often as you see fit. Plus, the grid-top design simplifies working with fluids and bagged goods because any spilled items will flow through the surface to the floor below.



EASILY STORE SUPPLIES & MATERIALS OFF THE GROUND

NEW

Expandable EZ Lock Platform Rack & Pallet



Quantum's NEW EZ Lock platform and pallet allows you to customize your storage space in seconds. Its patented interlocking design allows true flexibility in building the exact size pallet or platform you need. Using 12" x 40" footprints, each unit locks together making this an all purpose storage, moving, and shipping solution. Manufactured of recycled high density polyethylene, the vented deck is freezer safe and chemical resistant. Its one piece body design and structure allows for a 4 way forklift and hand truck entry, and it meets GMA industry standards. Enhances any 5S Lean initiative. Withstands temperatures from -30° F – 200° F and offers a 2,500 lb. load capacity when connected. Once built, the structure will maintain its dimensions with no sagging or stretching. Plastic will not absorb any liquids or chemicals and is resistant to insect infestation. Perfect for use in hospitals, pharmacies, clean rooms, food and beverage areas, manufacturing environments, and supermarket and grocery store back rooms. **Color:** Black

MODEL NO.	DIMENSIONS W" x L" x H"	CTN QTY	SHIP WGT
EL-12406	12" x 40" x 6"	1 Pair (2 Pieces)	12 lbs



**QUICK & TROUBLE-FREE ASSEMBLY
2,500 LB. LOAD CAPACITY**



LOCKING SYSTEMS

Simple locking system allows for quick and trouble-free assembly

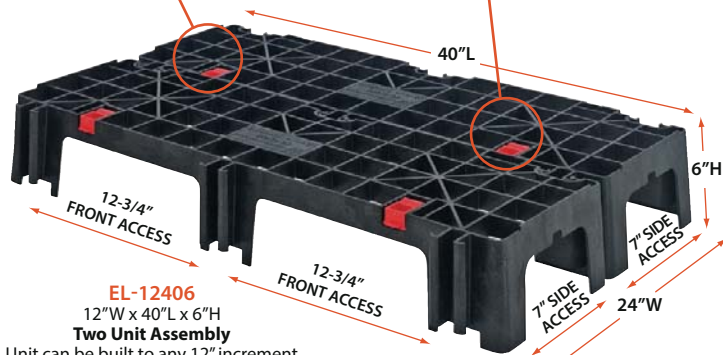

Work Station Carts - the ideal work-in-process cart

The sloped shelves allow for high visibility, productive rotations & gravity feed.

Cart Finish: Chrome

Each unit consists of:

- 2 - longer back posts
- 2 - shorter back posts
- 1 - flat wire shelf
- 1 - slanted wire shelf
- 4 - 5" swivel poly stem casters, 2 with brakes
- 4 - donut bumpers



MOBILE MODEL NO.	SHELF DIMENSIONS W" x L"	NO. OF SHELVES	SHIP WGT
Work Station Carts - 40"H			
M1836SL34C	18" x 36"	2	38 lbs
M1848SL34C	18" x 48"	2	48 lbs
M2436SL34C	24" x 36"	2	44 lbs
M2448SL34C	24" x 48"	2	50 lbs

M1836SL34C
Shown with Bins
(Bins are sold separately)

Slanted Shelf Carts - Stationary and Mobile

Stationary and Mobile Slanted Shelf units create a unique combination of modular components to enhance supply distribution applications. The sloped shelves allow for high visibility, productive rotations & gravity feed. (Note: Build a system with your bin requirements or consult a product specialist for appropriate components)

Each unit consists of:

- 4 - 63" posts
- 2 - flat wire shelves
- 3 - slanted wire shelves

Each mobile unit consists of:

- 4 - 63" posts
- 2 - flat wire shelves
- 3 - slanted wire shelves
- 4 - 5" swivel poly stem casters, 2 with brakes
- 4 - donut bumpers



MWRS-5-92060



WRSL6-74-1848-260

SLANTED SHELF CARTS - 63"H					
			STATIONARY	MOBILE	
SHELF DIMENSIONS W" x L"	NO. OF SHELVES	MODEL NO.	SHIP WGT	MODEL NO.	SHIP WGT
18" x 36"	5	1836SL6C	66 lbs	M1836SL6C	76 lbs
18" x 48"	5	1848SL6C	86 lbs	M1848SL6C	96 lbs
24" x 36"	5	2436SL6C	81 lbs	M2436SL6C	91 lbs
24" x 48"	5	2448SL6C	96 lbs	M2448SL6C	106 lbs

COMPLETE PACKAGES WITH BINS



MWRS-7-104

NO. OF BINS	BIN DIMENSIONS L" x W" x H"	NO. OF SHELVES	STATIONARY		MOBILE		
			MODEL NO.	SHIP WGT	MODEL NO.	SHIP WGT	
18"W x 36"L x 63"H Wire Shelving System with 2 Flat Shelves and 3 Slanted Shelves Includes Dividable Grid Containers available in Blue, Gray, Red and Clear							
12	DG92035	16-1/2" x 10-7/8" x 3-1/2"	5	WRS-5-92035	89 lbs	MWRS-5-92035	100 lbs
12	DG92060	16-1/2" x 10-7/8" x 6"	5	WRS-5-92060	96 lbs	MWRS-5-92060	107 lbs
12	DG92080	16-1/2" x 10-7/8" x 8"	5	WRS-5-92080	107 lbs	MWRS-5-92080	118 lbs
18"W x 36"L x 74"H Wire Shelving System with 2 Flat Shelves and 5 Slanted Shelves Includes Economy Shelf Bins available in Blue, Green, Ivory, Red, Yellow, Black and Clear							
48	QSB103	17-7/8" x 4-1/8" x 4"	7	WRS-7-103	118 lbs	MWRS-7-103	129 lbs
30	QSB104	17-7/8" x 6-5/8" x 4"	7	WRS-7-104	110 lbs	MWRS-7-104	121 lbs
24	QSB108	17-7/8" x 8-3/8" x 4"	7	WRS-7-108	113 lbs	MWRS-7-108	124 lbs
18	QSB110	17-7/8" x 11-1/8" x 4"	7	WRS-7-110	111 lbs	MWRS-7-110	122 lbs
18"W x 36"L x 74"H Wire Shelving System with 2 Flat Shelves and 5 Slanted Shelves Includes Euro Drawers available in Blue, Red, Yellow and Gray							
48	QED604	17-5/8" x 3-3/4" x 4-5/8"	7	WRS-7-604	144 lbs	MWRS-7-604	155 lbs
30	QED602	17-5/8" x 5-9/16" x 4-5/8"	7	WRS-7-602	126 lbs	MWRS-7-602	137 lbs
18	QED606	17-5/8" x 8-3/8" x 4-5/8"	7	WRS-7-606	132 lbs	MWRS-7-606	143 lbs
18"W x 48"L x 74"H Wire Shelving System with 2 Flat Shelves and 4 Slanted Shelves Includes Ultra Bins available in Blue, Green, Ivory, Red, Yellow, Black and Clear							
16	QUS260	18" x 11" x 10"	6	WRSL6-74-1848-260	168 lbs	WRCSL6-74-1848-260	179 lbs
24"W x 48"L x 74"H Wire Shelving System with 2 Flat Shelves and 4 Slanted Shelves Includes Hulk 24" Containers available in Blue, Red, Yellow and Clear							
16	QUS953	23-7/8" x 11" x 10"	6	WRSL6-74-2448-953	184 lbs	WRCSL6-74-2448-953	195 lbs



LOWEST PRICE GUARANTEED!

Slanted Shelf with Bin Holders Combo Carts

A systems cart that offers hanging bins, slanted bins and bins on a flat surface all in one unit. Cart offer multiple applications the ability to store pre-packed items or sloped storage for dispensing small parts. This combination creates a highly customized exchange and storage system. **Cart Finish:** Chrome

Available in: ● Blue ● Green ● Ivory ● Red ● Yellow ● Black ● Clear

MODEL NO.	NO. OF SHELVES	NO. OF BINS	BIN DIMENSIONS L" x W" x H"	SHIP WGT
18" x 36" x 80" Slanted Wire Shelf Cart with Bin Holders and Bins				
WRCSL5-74-1836-104220	5	20 QSB104 24 QUS220	17-7/8" x 6-5/8" x 4" 7-3/8" x 4-1/8" x 3"	105 lbs
WRCSL5-74-1836-104230	5	20 QSB104 18 QUS230	17-7/8" x 6-5/8" x 4" 10-7/8" x 5-1/2" x 5"	112 lbs
18" x 48" x 80" Slanted Wire Shelf Cart with Bin Holders and Bins				
WRCSL5-74-1848-104220	5	24 QSB104 30 QUS220	17-7/8" x 6-5/8" x 4" 7-3/8" x 4-1/8" x 3"	128 lbs

Slanted Shelf Carts - Open or Enclosed

Units are designed for quick and easy accessibility for pre-packed items. The wire end panel maintains product while the slanted shelf allows for gravity feed. Available with or without side enclosures. **Cart Finish:** Chrome

OPEN		ENCLOSED	
MODEL NO.	SHIP WGT	MODEL NO.	SHIP WGT
5 Shelf, Slanted Cart 2 Horizontal Shelves and 3 Slanted Shelves			
WRCSL5-63-1836	76 lbs	WRCSL5-63-1836EP	88 lbs
WRCSL5-63-1848	96 lbs	WRCSL5-63-1848EP	108 lbs
WRCSL5-63-2436	91 lbs	WRCSL5-63-2436EP	105 lbs
WRCSL5-63-2448	106 lbs	WRCSL5-63-2448EP	120 lbs

COMPLETE PACKAGES WITH BINS



WRCSL5-74-1836-104230



WRCSL5-63-1836EP

Dividers, Bin Cups and Clear Label Holders
See pg. 50

QUANTUM HAS A NEW ANGLE FOR STORAGE



WRCSL5-63-1836-104

Available in: ● Blue ● Green ● Ivory ● Red ● Yellow ● Black ● Clear

		OPEN		ENCLOSED	
NO. OF BINS	BIN DIMENSIONS L" x W" x H"	MODEL NO.	SHIP WGT	MODEL NO.	SHIP WGT
5 Shelf, Slanted Shelf Cart with Bins 2 Horizontal Shelves and 3 Slanted Shelves					
20 QSB104	17-7/8" x 6-5/8" x 4"	WRCSL5-63-1836-104	94 lbs	WRCSL5-63-1836EP-104	103 lbs
28 QSB104	17-7/8" x 6-5/8" x 4"	WRCSL5-63-1848-104	114 lbs	WRCSL5-63-1848EP-104	123 lbs
20 QSB106	23-5/8" x 6-5/8" x 4"	WRCSL5-63-2436-106	115 lbs	WRCSL5-63-2436EP-106	131 lbs
28 QSB106	23-5/8" x 6-5/8" x 4"	WRCSL5-63-2448-106	136 lbs	WRCSL5-63-2448EP-106	152 lbs

Bin Cart Systems

Bin cart can be used for transporting and holding product. A modular drawer system allows for storage of smaller specialty components while the open shelf design maximizes the storage area. The option of cart covers **pg. 140**, enclosure panels **pg. 150**, ledges and dividers **pg. 151** add to the flexibility of the unit. Dividable grids are available in Blue, Red, Gray and Clear. **Cart Finish:** Chrome

Available in: ● Blue ● Red ● Gray ● Clear

MODEL NO.	NO. OF BINS	BIN DIMENSIONS L" x W" x H"	SHIP WGT
24"W x 36"L x 69"H Bin Cart with Dividable Grids			
WRC5-63-2436-93060	4 DG93060	22-1/2" x 17-1/2" x 6"	113 lbs
24"W x 48"L x 69"H Bin Cart with Dividable Grids			
WRC5-63-2448-93060	4 DG93060	22-1/2" x 17-1/2" x 6"	128 lbs
24"W x 60"L x 69"H Bin Cart with Dividable Grids			
WRC5-63-2460-93060	4 DG93060	22-1/2" x 17-1/2" x 6"	153 lbs



WRC5-63-2436-93060

- Each unit consists of:
- 4 - 63" posts
 - 5 - wire shelves
 - 4 - **DS18-24** bin slides
 - 4 - 5" swivel poly stem casters, 2 with brake
 - 4 - donut bumpers
 - 4 - **DG93060** bins (Blue, Red, Gray & Clear)

COMPLETE PACKAGES WITH BINS



Dividers

Containers can be divided by length and/or width allowing a subdivision down to a 1-1/8" square compartment size. See **pg. 67**



Clear Acrylic Inlays

Keep stored items visible while protecting against airborne dust and other contaminants. Cover lays inside on rim of container. See **pg. 67**

Bin Carts

Offering two heights and four bin quantity designs, these modular carts are the ultimate work-in-process and transport cart. Dividable grids slide easily in and out and with their ability to be divided into multiple compartments with long and short dividers, truly any type of storage is possible, see **pg. 67** for dividers and label holders. Dividable grids are available in Blue, Red, Gray and Clear. **Cart Finish:** Chrome

Available in: ● Blue ● Red ● Gray ● Clear

MODEL NO.	NO. OF BINS	BIN DIMENSIONS L" x W" x H"	SHIP WGT
21"W x 24"L x 45"H Bin Cart with Dividable Grid Containers			
BC212434M1	4 DG93060	22-1/2" x 17-1/2" x 6"	58 lbs
BC212439M2	7 DG93030	22-1/2" x 17-1/2" x 3"	79 lbs
21"W x 24"L x 69"H Bin Cart with Dividable Grid Containers			
BC212469M1	7 DG93060	22-1/2" x 17-1/2" x 6"	107 lbs
BC212469M2	11 DG93030	22-1/2" x 17-1/2" x 3"	111 lbs
21"W x 24"L x 45"H Bin Cart with No Dividable Grid Containers			
BC212439M4	No containers (includes slides for 4 bin levels)		46 lbs
BC212439M7	No containers (includes slides for 7 bin levels)		55 lbs
21"W x 24"L x 69"H Bin Cart with No Dividable Grid Containers			
BC212469M	No containers (includes slides for 7 bin levels)		63 lbs
BC212469M11	No containers (includes slides for 11 bin levels)		75 lbs
WR-S24W	-	-	3 lbs



BC212434M1



BC212469M1



LOWEST PRICE GUARANTEED!



BC214069M1D

CLEAR BIN VIEW

Double & Triple Bay Bin Carts

NEW

Offering double or triple bays and four bin quantity designs, these modular carts are the ultimate work-in-process and transport cart. Dividable grids slide easily in and out and with their ability to be divided into multiple compartments with long and short dividers, truly any type of storage is possible, see **pg. 67** for dividers and label holders. Dividable grids are available in Blue, Red, Gray and Clear. **Cart Finish:** Chrome

Double Bay Bin Carts

Available in: ● Blue ● Red ● Gray ● Clear

MODEL NO.	NO. OF BINS	BIN DIMENSIONS L" x W" x H"	SHIP WGT
24"W x 40"L x 69"H Bin Cart with Dividable Grid Containers			
BC214069M1D	14 DG93060	22-1/2" x 17-1/2" x 6"	163 lbs
BC214069M2D	22 DG93030	22-1/2" x 17-1/2" x 3"	164 lbs
24"W x 40"L x 69"H Bin Cart with No Dividable Grid Containers			
BC214069M14D	No containers (includes slides for 14 bin levels)		75 lbs
BC214069M22D	No containers (includes slides for 22 bin levels)		91 lbs
One Pair - 24" Wire Single Bin Slides			
WR-S24W	-	-	3 lbs
One - 24" Wire Double Bin Slides			
WR-D24W	-	-	2 lbs

COMPLETE PACKAGES WITH BINS

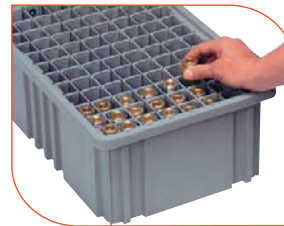

Dividers

Containers can be divided by length and/or width allowing a subdivision down to a 1-1/8" square compartment size. See **pg. 67**



Clear Acrylic Inlays

Keep stored items visible while protecting against airborne dust and other contaminants. Cover lays inside on rim of container. See **pg. 67**



BC216069M2T

Triple Bay Bin Carts

Available in: ● Blue ● Red ● Gray ● Clear

MODEL NO.	NO. OF BINS	BIN DIMENSIONS L" x W" x H"	SHIP WGT
24"W x 60"L x 69"H Bin Cart with Dividable Grid Containers			
BC216069M1T	21 DG93060	22-1/2" x 17-1/2" x 6"	233 lbs
BC216069M2T	33 DG93030	22-1/2" x 17-1/2" x 3"	234 lbs
24"W x 60"L x 69"H Bin Cart with No Dividable Grid Containers			
BC216069M21T	No containers (includes slides for 21 bin levels)		100 lbs
BC216069M33T	No containers (includes slides for 33 bin levels)		124 lbs
One Pair - 24" Wire Single Bin Slides			
WR-S24W	-	-	3 lbs
One - 24" Wire Double Bin Slides			
WR-D24W	-	-	2 lbs

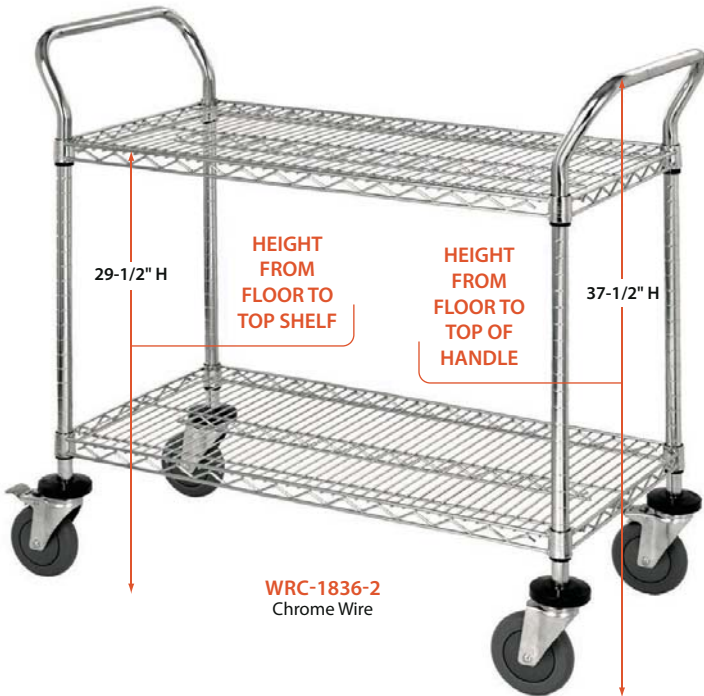

WRC-1836-2
Chrome Wire

Cylinder Transport / Inhalation Therapy Cart

Mobile unit can transport up to 12 of the D and/or E cylinders. Protective vinyl coated wires separate and protect cylinders. Unit consists of two u-handles, 4 donut bumpers, 4 conductive swivel casters (2 with brakes), 1 wire shelf and 2 frames with coated wire grid shelf.
Wire Finish: Chrome



WRC-IT1824
(Cylinders not included)

MODEL NO.	SHIP WGT
Mobile Cylinder Cart 18" x 24" x 37-1/2"	
WRC-IT1824	45 lbs

**UTILITY CARTS
IN ANY STYLE OR CONFIGURATION**



WRC-1836-2CG
Chrome Wire & Solid Galvanized



WRSC-1836-3SS
Solid Stainless Steel



WRC-1836BK-3
Black Wire

Wire Utility Carts

Give versatility to any operation: food service, hospitals and maintenance. Carts consists of 2 u-handles, 4 donut bumpers, 4 swivel casters (2 with brakes) and wire or solid shelf combinations.

DIMENSIONS W" x L" x H"	WIRE SHELF				WIRE & SOLID SHELF			SOLID SHELF		
	CHROME MODEL NO.	STAINLESS MODEL NO.	BLACK MODEL NO.	SHIP WGT	CHROME MODEL NO.	STAINLESS MODEL NO.	SHIP WGT	GALVANIZED MODEL NO.	STAINLESS MODEL NO.	SHIP WGT
2 Wire Shelf Mobile Utility Cart										
18" x 36" x 37-1/2"	WRC-1836-2	WRSC-1836-2	WRC-1836BK-2	30 lbs	1 Wire & 1 Solid Shelf Mobile Utility Cart			2 Solid Shelf Mobile Utility Cart		
18" x 42" x 37-1/2"	WRC-1842-2	WRSC-1842-2	-	32 lbs						
18" x 48" x 37-1/2"	WRC-1848-2	WRSC-1848-2	WRC-1848BK-2	37 lbs						
24" x 36" x 37-1/2"	WRC-2436-2	WRSC-2436-2	WRC-2436BK-2	36 lbs						
24" x 42" x 37-1/2"	WRC-2442-2	WRSC-2442-2	-	40 lbs						
24" x 48" x 37-1/2"	WRC-2448-2	WRSC-2448-2	WRC-2448BK-2	44 lbs	WRC-1836-2CG	WRSC-1836SS-2S	37 lbs	WRC-1836-2G	WRSC-1836-2SS	44 lbs
3 Wire Shelf Mobile Utility Cart										
18" x 36" x 37-1/2"	WRC-1836-3	WRSC-1836-3	WRC-1836BK-3	37 lbs	2 Wire & 1 Solid Shelf Mobile Utility Cart			3 Solid Shelf Mobile Utility Cart		
18" x 42" x 37-1/2"	WRC-1842-3	WRSC-1842-3	-	42 lbs						
18" x 48" x 37-1/2"	WRC-1848-3	WRSC-1848-3	WRC-1848BK-3	48 lbs						
24" x 36" x 37-1/2"	WRC-2436-3	WRSC-2436-3	WRC-2436BK-3	49 lbs						
24" x 42" x 37-1/2"	WRC-2442-3	WRSC-2442-3	-	55 lbs						
24" x 48" x 37-1/2"	WRC-2448-3	WRSC-2448-3	WRC-2448BK-3	60 lbs	WRC-1836-3CG	WRSC-1836SS-3S	46 lbs	WRC-1836-3G	WRSC-1836-3SS	60 lbs
18" x 42" x 37-1/2"	WRC-1842-3	WRSC-1842-3	-	42 lbs	WRC-1842-3CG	WRSC-1842SS-3S	49 lbs	WRC-1842-3G	WRSC-1842-3SS	68 lbs
18" x 48" x 37-1/2"	WRC-1848-3	WRSC-1848-3	WRC-1848BK-3	48 lbs	WRC-1848-3CG	WRSC-1848SS-3S	52 lbs	WRC-1848-3G	WRSC-1848-3SS	76 lbs
24" x 36" x 37-1/2"	WRC-2436-3	WRSC-2436-3	WRC-2436BK-3	49 lbs	WRC-2436-3CG	WRSC-2436SS-3S	55 lbs	WRC-2436-3G	WRSC-2436-3SS	67 lbs
24" x 42" x 37-1/2"	WRC-2442-3	WRSC-2442-3	-	55 lbs	WRC-2442-3CG	WRSC-2442SS-3S	62 lbs	WRC-2442-3G	WRSC-2442-3SS	76 lbs
24" x 48" x 37-1/2"	WRC-2448-3	WRSC-2448-3	WRC-2448BK-3	60 lbs	WRC-2448-3CG	WRSC-2448SS-3S	68 lbs	WRC-2448-3G	WRSC-2448-3SS	84 lbs



LOWEST PRICE GUARANTEED!

Modular Trays



Heavy-duty 18" x 26" white trays are NSF approved for use for food service or may be used for standard applications. Perimeter ends are reinforced for additional strength. 20" x 26" size offers a deep stacking tray. Both tray sizes are available in ESD complying to ANSI / ESD standards for the use in PC board assembly and handling. All trays are manufactured of fiberglass reinforced theroset material, allowing up to 200 lb. weight capacity when evenly distributed. Quantum's modular trays will withstand temperatures of -40°F to +350°F. 18" x 26" Trays available in White and ESD, 20" x 26" Trays are available in Gray, White and ESD.

Available in: ● Gray ○ White ● Black

MODEL NO.	DIMENSIONS W" x L" x H"	SHIP WGT
18" x 26" Trays		
1826TR	18" x 26" x 1-1/8" White Tray	4 lbs
1826ESD	18" x 26" x 1-1/8" Black ESD Tray	4 lbs
20" x 26" Stackable Trays		
2026TRGY	20" x 26" x 1-1/2" Gray Tray	5 lbs
2026TRWT	20" x 26" x 1-1/2" White Tray	5 lbs
2026ESD	20" x 26" x 1-1/2" Black ESD Tray	5 lbs

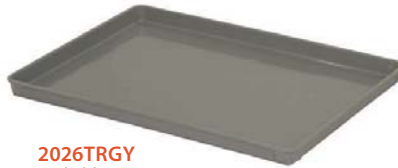

2026TRGY
Stackable Tray



1826TR



1826ESD

Tray Slides



Efficiently utilize space between shelves using standard trays and/or bins.

- Available in 18" and 24" depths
- Accommodates up to 10 trays

MODEL NO.	DESCRIPTION	SHIP WGT
Tray Slide		
TS18C	18" Tray Slide Set	10 lbs
TS24C	24" Tray Slide Set	11 lbs



Modular Tray Carts

Tray Carts are offered in half size and full size units, designed to handle work in process. ESD trays can be used on tray cart for conductive applications with the addition of conductive plastic split sleeves (WR-SSCO) and a drag chain (ESD-DC). Optional Tray Stop prevents trays from falling out. **Cart Finish:** Chrome

MODEL NO.	DIMENSIONS W" x L" x H"	CAPACITY	SHIP WGT	TRAY STOP MODEL NO.
39"H Side Load Tray Cart				
TC-19	18" x 30" x 39"	19 Trays	45 lbs	TS32C
69"H Side Load Tray Carts				
TC-39	18" x 30" x 69"	39 Trays	74 lbs	TS62C
TC-31	21" x 30" x 69"	31 Trays	68 lbs	TS62C
69"H End Load Tray Cart				
TC-EL38	21-3/4" x 27" x 69"	38 Trays	74 lbs	TS62C

Trays are sold separately.



TC-19 + 1826TR
(Trays sold separately)



TC-EL38
End Load Cart
(Trays sold separately)



TC-39 + 1826TR
Tray Stops can be used on back as shown here or one in the back and one in the front.
(Trays sold separately)

TS62C
Tray Stop
(Optional)

200 lb. CAPACITY PER TRAY

Conductive Options



ESD-DC
Drag Chain



WR-SSCO
Plastic Conductive
Split Sleeve

Cart Covers

Protect against pilferage, airborne dust, water and other contaminants. Velcro and zipper flap are available in clear-vinyl and blue and white denier nylon fabric. Clear vinyl is 10 gauge. Blue and white nylon fabric is 400 Denier. Specify zipper or velcro for closure. Call for more information.

CART COVERS OPTIONS AVAILABLE

- Custom sizes
- Hand openings
- Handle holes / slits
- Bottom tie tapes (*attach to posts*)
- Extra velcro strips
- Double flap
- Clear front flap
- Metal grommets
- 9" X 12" pocket / document holder
- Custom logos

TO ORDER:

- 1) Choose size
- 2) Select color:
 Clear Vinyl add suffix **CV**
 Blue Nylon add suffix **BN**
 White Nylon add suffix **WN**
- 3) Choose Zipper or Velcro



CLEAR VINYL

COVERS PROTECT AGAINST PILFERAGE, AIRBORNE DUST, MOISTURE AND OTHER CONTAMINANTS



BLUE NYLON



WHITE NYLON

63"H CART COVER				74"H CART COVER			
		400 DENIER	CLEAR VINYL			400 DENIER	CLEAR VINYL
DIMENSIONS	SHIP WGT	MODEL NO.	MODEL NO.	DIMENSIONS	SHIP WGT	MODEL NO.	MODEL NO.
18" x 36" x 63"	3 lbs	CC183663	CC183663CV	18" x 36" x 74"	4 lbs	CC183674	CC183674CV
18" x 48" x 63"	4 lbs	CC184863	CC184863CV	18" x 48" x 74"	5 lbs	CC184874	CC184874CV
18" x 60" x 63"	5 lbs	CC186063	CC186063CV	18" x 60" x 74"	6 lbs	CC186074	CC186074CV
18" x 72" x 63"	6 lbs	CC187263	CC187263CV	18" x 72" x 74"	7 lbs	CC187274	CC187274CV
24" x 36" x 63"	3 lbs	CC243663	CC243663CV	24" x 36" x 74"	4 lbs	CC243674	CC243674CV
24" x 48" x 63"	4 lbs	CC244863	CC244863CV	24" x 48" x 74"	5 lbs	CC244874	CC244874CV
24" x 60" x 63"	5 lbs	CC246063	CC246063CV	24" x 60" x 74"	6 lbs	CC246074	CC246074CV
24" x 72" x 63"	6 lbs	CC247263	CC247263CV	24" x 72" x 74"	7 lbs	CC247274	CC247274CV



LOWEST PRICE GUARANTEED!



M1836C46



M1836CG46-5



M1836SG46

Stem Caster Carts

4 or 5 Wire Shelf Mobile Carts

DIMENSIONS W" x L" x H"	4 SHELF CARTS		5 SHELF CARTS	
	MODEL NO.	SHIP WGT	MODEL NO.	SHIP WGT
63"H Post, 5" Stem Caster Carts				
18" x 36" x 69"	M1836C46	68 lbs	M1836C46-5	72 lbs
18" x 48" x 69"	M1848C46	76 lbs	M1848C46-5	84 lbs
18" x 60" x 69"	M1860C46	97 lbs	M1860C46-5	107 lbs
24" x 36" x 69"	M2436C46	80 lbs	M2436C46-5	87 lbs
24" x 48" x 69"	M2448C46	94 lbs	M2448C46-5	102 lbs
24" x 60" x 69"	M2460C46	116 lbs	M2460C46-5	127 lbs
74"H Post, 5" Stem Caster Carts				
18" x 36" x 80"	M1836C47	70 lbs	M1836C47-5	74 lbs
18" x 48" x 80"	M1848C47	78 lbs	M1848C47-5	86 lbs
18" x 60" x 80"	M1860C47	99 lbs	M1860C47-5	109 lbs
24" x 36" x 80"	M2436C47	82 lbs	M2436C47-5	89 lbs
24" x 48" x 80"	M2448C47	96 lbs	M2448C47-5	104 lbs
24" x 60" x 80"	M2460C47	118 lbs	M2460C47-5	129 lbs

Mobile wire stem caster carts add versatility & flexibility to any operation, creating a transport system.

- Supply & distribution
- Stock rotation
- Laundry
- Staging

Each unit consists of:

- 4 - posts
- 4 or 5 - wire shelves
- 4 - donut bumpers
- 4 - 5" poly stem casters, 2 with brakes

3 or 4 Wire / 1 Solid Shelf Mobile Carts

DIMENSIONS W" x L" x H"	4 SHELF CARTS		5 SHELF CARTS	
	MODEL NO.	SHIP WGT	MODEL NO.	SHIP WGT
63"H Post, 5" Stem Caster Carts				
18" x 36" x 69"	M1836CG46	68 lbs	M1836CG46-5	78 lbs
18" x 48" x 69"	M1848CG46	76 lbs	M1848CG46-5	90 lbs
18" x 60" x 69"	M1860CG46	97 lbs	M1860CG46-5	114 lbs
24" x 36" x 69"	M2436CG46	80 lbs	M2436CG46-5	93 lbs
24" x 48" x 69"	M2448CG46	94 lbs	M2448CG46-5	110 lbs
24" x 60" x 69"	M2460CG46	116 lbs	M2460CG46-5	137 lbs
74"H Post, 5" Stem Caster Carts				
18" x 36" x 80"	M1836CG47	70 lbs	M1836CG47-5	80 lbs
18" x 48" x 80"	M1848CG47	78 lbs	M1848CG47-5	92 lbs
18" x 60" x 80"	M1860CG47	99 lbs	M1860CG47-5	116 lbs
24" x 36" x 80"	M2436CG47	82 lbs	M2436CG47-5	95 lbs
24" x 48" x 80"	M2448CG47	96 lbs	M2448CG47-5	112 lbs
24" x 60" x 80"	M2460CG47	118 lbs	M2460CG47-5	139 lbs

Stem caster cart with solid bottom shelf. The unique combination of wire and solid shelves allows for air circulation & high visibility. The solid shelf in the bottom position prevents dust and dirt to rise and contains spillage.

Each unit consists of:

- 4 - posts
- 3 or 4 - wire shelves
- 1 - solid shelf
- 4 - donut bumpers
- 4 - 5" poly stem casters, 2 with brakes

4 or 5 Solid Shelf Mobile Carts

DIMENSIONS W" x L" x H"	4 SHELF CARTS		5 SHELF CARTS	
	MODEL NO.	SHIP WGT	MODEL NO.	SHIP WGT
63"H Post, 5" Stem Caster Carts				
18" x 36" x 69"	M1836SG46	86 lbs	M1836SG46-5	102 lbs
18" x 48" x 69"	M1848SG46	102 lbs	M1848SG46-5	122 lbs
18" x 60" x 69"	M1860SG46	118 lbs	M1860SG46-5	142 lbs
24" x 36" x 69"	M2436SG46	98 lbs	M2436SG46-5	117 lbs
24" x 48" x 69"	M2448SG46	102 lbs	M2448SG46-5	126 lbs
24" x 60" x 69"	M2460SG46	146 lbs	M2460SG46-5	177 lbs
74"H Post, 5" Stem Caster Carts				
18" x 36" x 80"	M1836SG47	88 lbs	M1836SG47-5	104 lbs
18" x 48" x 80"	M1848SG47	104 lbs	M1848SG47-5	124 lbs
18" x 60" x 80"	M1860SG47	120 lbs	M1860SG47-5	144 lbs
24" x 36" x 80"	M2436SG47	100 lbs	M2436SG47-5	119 lbs
24" x 48" x 80"	M2448SG47	104 lbs	M2448SG47-5	128 lbs
24" x 60" x 80"	M2460SG47	148 lbs	M2460SG47-5	179 lbs

Stem caster solid shelf cart is an easy way to transport tools and inventories.

Each unit consists of:

- 4 - posts
- 4 or 5 - solid shelves
- 4 - donut bumpers
- 4 - 5" poly stem casters, 2 with brakes

Enclosure Carts

Enclosure carts are an effective way to keep contents from moving or falling off during transportation.

Enclosure carts using rods and tabs are adaptable to any shelf position.

Enclosure dolly base truck using rods & tabs allows for heavier load transport. The rods & tabs act as a perimeter to retain product.

For additional shelves, refer to **pg. 104**.

All units consist of:

- 4 - posts
- 4 or 5 - wire shelves
- 4, 5 or 6 - rods & tabs kits

Mobile unit also includes:

- 4 - 5" swivel poly stem casters, 2 with brakes
- 4 - donut bumpers

Dolly Base unit also includes:

- 1 - dolly base
- 4 - plate casters (2 rigid and 2 swivel with brake)

COMPLETE CARTS INCLUDE CASTER KIT FOR MOBILITY



M1836C46RE



MD1836C46RE-5

3 SIDED, 4 OR 5 WIRE SHELF CART WITH RODS & TABS

DIMENSIONS W" x L" x H"	4 SHELF CARTS		5 SHELF CARTS	
	MODEL NO.	SHIP WGT	MODEL NO.	SHIP WGT
63"H Post, Cart with Rods and Tabs				
18" x 36" x 69"	M1836C46RE	74 lbs	M1836C46RE-5	84 lbs
18" x 48" x 69"	M1848C46RE	84 lbs	M1848C46RE-5	98 lbs
18" x 60" x 69"	M1860C46RE	100 lbs	M1860C46RE-5	117 lbs
24" x 36" x 69"	M2436C46RE	88 lbs	M2436C46RE-5	101 lbs
24" x 48" x 69"	M2448C46RE	104 lbs	M2448C46RE-5	120 lbs
24" x 60" x 69"	M2460C46RE	124 lbs	M2460C46RE-5	145 lbs
74"H Post, Cart with Rods and Tabs				
18" x 36" x 80"	M1836C47RE	80 lbs	M1836C47RE-5	90 lbs
18" x 48" x 80"	M1848C47RE	92 lbs	M1848C47RE-5	106 lbs
18" x 60" x 80"	M1860C47RE	104 lbs	M1860C47RE-5	121 lbs
24" x 36" x 80"	M2436C47RE	94 lbs	M2436C47RE-5	107 lbs
24" x 48" x 80"	M2448C47RE	112 lbs	M2448C47RE-5	128 lbs
24" x 60" x 80"	M2460C47RE	132 lbs	M2460C47RE-5	153 lbs

DOLLY BASE 3 SIDED, 4 OR 5 WIRE SHELF CART WITH RODS & TABS

DIMENSIONS W" x L" x H"	4 SHELF CARTS		5 SHELF CARTS	
	MODEL NO.	SHIP WGT	MODEL NO.	SHIP WGT
63"H Post, Dolly Base Carts				
18" x 36" x 70"	MD1836C46RE	86 lbs	MD1836C46RE-5	96 lbs
18" x 48" x 70"	MD1848C46RE	96 lbs	MD1848C46RE-5	110 lbs
18" x 60" x 70"	MD1860C46RE	124 lbs	MD1860C46RE-5	141 lbs
24" x 36" x 70"	MD2436C46RE	113 lbs	MD2436C46RE-5	126 lbs
24" x 48" x 70"	MD2448C46RE	121 lbs	MD2448C46RE-5	137 lbs
24" x 60" x 70"	MD2460C46RE	144 lbs	MD2460C46RE-5	165 lbs
74"H Post, Dolly Base Carts				
18" x 36" x 81"	MD1836C47RE	92 lbs	MD1836C47RE-5	102 lbs
18" x 48" x 81"	MD1848C47RE	106 lbs	MD1848C47RE-5	120 lbs
18" x 60" x 81"	MD1860C47RE	120 lbs	MD1860C47RE-5	137 lbs
24" x 36" x 81"	MD2436C47RE	108 lbs	MD2436C47RE-5	121 lbs
24" x 48" x 81"	MD2448C47RE	129 lbs	MD2448C47RE-5	145 lbs
24" x 60" x 81"	MD2460C47RE	152 lbs	MD2460C47RE-5	173 lbs

Rods & Tabs

Rods & tabs represent an economical, alternate solution for enclosure on backs and sides of mobile and stationary units.

Each kit includes:

- 3 - rods
- 9 - front/back tabs
- 9 - side/solid shelf tabs.

MODEL NO.	DESCRIPTION	SHIP WGT
Rods & Tabs		
52RT	3 - 52" Rods with tabs	1 lb
61RT	3 - 61" Rods with tabs	1 lb
72RT	3 - 72" Rods with tabs	2 lbs
84RT	3 - 84" Rods with tabs	2 lbs



QSRT
Side / Solid Shelf Tab



QAT
Front/Back Tab





LOWEST PRICE GUARANTEED!

Enclosure Carts

Enclosure carts are an effective way to keep contents from moving or falling off during transportation.

Enclosure carts using rods and tabs are adaptable to any shelf position.

Enclosure dolly base truck using rods & tabs allows for heavier load transport. The rods & tabs act as a perimeter to retain product.

For additional shelves, refer to **pg. 104**.

All units consist of:

- 4 - posts
- 3 or 4 - wire shelves
- 1 - solid shelf
- 4, 5 or 6 - rods & tabs kits

Mobile unit also includes:

- 4 - 5" swivel poly stem casters, 2 with brakes
- 4 - donut bumpers

Dolly Base unit also includes:

- 1 - dolly base
- 4 - plate casters (2 rigid and 2 swivel with brake)

COMPLETE CARTS INCLUDE CASTER KIT FOR MOBILITY

NYLON FABRIC OR CLEAR VINYL CART COVERS AVAILABLE

See **pg. 140**

3 SIDED STEM CASTER WIRE SHELF CART WITH 3 OR 4 WIRE SHELVES AND 1 SOLID SHELF WITH RODS & TABS

DIMENSIONS W" x L" x H"	4 SHELF CARTS		5 SHELF CARTS	
	MODEL NO.	SHIP WGT	MODEL NO.	SHIP WGT
63"H Post, Cart with Rods and Tabs				
18" x 36" x 69"	M1836CG46RE	83 lbs	M1836CG46RE-5	93 lbs
18" x 48" x 69"	M1848CG46RE	94 lbs	M1848CG46RE-5	108 lbs
18" x 60" x 69"	M1860CG46RE	114 lbs	M1860CG46RE-5	131 lbs
24" x 36" x 69"	M2436CG46RE	96 lbs	M2436CG46RE-5	109 lbs
24" x 48" x 69"	M2448CG46RE	112 lbs	M2448CG46RE-5	128 lbs
24" x 60" x 69"	M2460CG46RE	136 lbs	M2460CG46RE-5	157 lbs
74"H Post, Cart with Rods and Tabs				
18" x 36" x 80"	M1836CG47RE	89 lbs	M1836CG47RE-5	99 lbs
18" x 48" x 80"	M1848CG47RE	101 lbs	M1848CG47RE-5	115 lbs
18" x 60" x 80"	M1860CG47RE	123 lbs	M1860CG47RE-5	140 lbs
24" x 36" x 80"	M2436CG47RE	102 lbs	M2436CG47RE-5	115 lbs
24" x 48" x 80"	M2448CG47RE	119 lbs	M2448CG47RE-5	135 lbs
24" x 60" x 80"	M2460CG47RE	136 lbs	M2460CG47RE-5	166 lbs



M1836CG46RE

DOLLY BASE 3 SIDED WIRE SHELF CART WITH 3 OR 4 WIRE SHELVES AND 1 SOLID SHELF WITH RODS & TABS

DIMENSIONS W" x L" x H"	4 SHELF CARTS		5 SHELF CARTS	
	MODEL NO.	SHIP WGT	MODEL NO.	SHIP WGT
63"H Post, Dolly Base Carts				
18" x 36" x 70"	MD1836CG46RE	93 lbs	MD1836CG46RE-5	102 lbs
18" x 48" x 70"	MD1848CG46RE	106 lbs	MD1848CG46RE-5	116 lbs
18" x 60" x 70"	MD1860CG46RE	128 lbs	MD1860CG46RE-5	147 lbs
24" x 36" x 70"	MD2436CG46RE	109 lbs	MD2436CG46RE-5	132 lbs
24" x 48" x 70"	MD2448CG46RE	127 lbs	MD2448CG46RE-5	145 lbs
24" x 60" x 70"	MD2460CG46RE	154 lbs	MD2460CG46RE-5	175 lbs
74"H Post, Dolly Base Carts				
18" x 36" x 81"	MD1836CG47RE	99 lbs	MD1836CG47RE-5	108 lbs
18" x 48" x 81"	MD1848CG47RE	113 lbs	MD1848CG47RE-5	126 lbs
18" x 60" x 81"	MD1860CG47RE	137 lbs	MD1860CG47RE-5	143 lbs
24" x 36" x 81"	MD2436CG47RE	115 lbs	MD2436CG47RE-5	127 lbs
24" x 48" x 81"	MD2448CG47RE	134 lbs	MD2448CG47RE-5	153 lbs
24" x 60" x 81"	MD2460CG47RE	163 lbs	MD2460CG47RE-5	183 lbs



MD1836CG46RE-5



WHITE NYLON



BLUE NYLON



CLEAR VINYL

CART COVER

Protect against pilferage, airborne dust, moisture and other contaminants

Enclosure Linen Carts

Finish: Chrome

Each cart consists of:

- 4 - posts
- 4 or 5 - wire shelves
- 4 - enclosure panels
- 4 - 5" swivel poly stem casters, 2 with brakes
- 4 - donut bumpers

All Carts consist of:

- 4 - posts
- 3 or 4 - wire shelves
- 1 - solid shelf
- 4 or 5 - enclosure panels

Mobile cart also includes:

- 4 - 5" swivel poly stem casters, 2 with brakes
- 4 - donut bumpers

Dolly Base cart also includes:

- 1 - dolly base
- 4 - plate casters (2 rigid and 2 swivel with brake)

NYLON FABRIC OR CLEAR VINYL CART COVERS AVAILABLE

See pg. 140

CART COVER

Protect against pilferage, airborne dust, moisture and other contaminants



BLUE NYLON

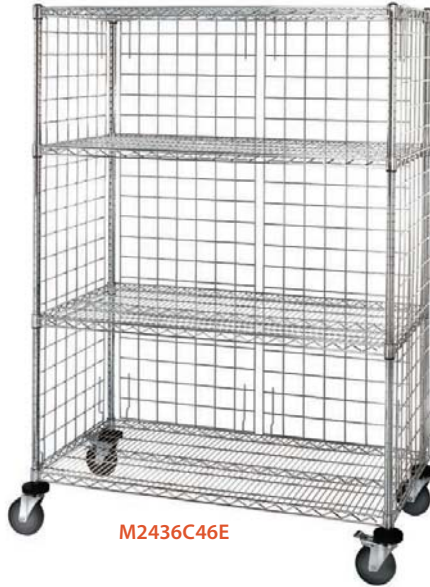

M2436C46E



WRCS4-63-2460EP-5



WRDBS4-63-2460EP

3 SIDED, 4 OR 5 WIRE SHELF CART WITH ENCLOSURE PANELS

DIMENSIONS W" x L" x H"	4 SHELF CARTS		5 SHELF CARTS	
	MODEL NO.	SHIP WGT	MODEL NO.	SHIP WGT
63"H Post, Cart with Enclosure Panels				
24" x 36" x 69"	M2436C46E	145 lbs	M2436C46E-5	158 lbs
24" x 48" x 69"	M2448C46E	179 lbs	M2448C46E-5	195 lbs
24" x 60" x 69"	M2460C46E	197 lbs	M2460C46E-5	218 lbs

COMPLETE CARTS INCLUDE CASTER KIT FOR MOBILITY

3 SIDED STEM CASTER LINEN CART WITH 3 OR 4 WIRE SHELVES AND 1 SOLID SHELF WITH ENCLOSURE PANELS

DIMENSIONS W" x L" x H"	4 SHELF CARTS		5 SHELF CARTS	
	MODEL NO.	SHIP WGT	MODEL NO.	SHIP WGT
63"H Post, 5" Stem Caster Cart with Solid Bottom Shelf and Enclosure Panels				
24" x 36" x 69"	WRCS4-63-2436EP	113 lbs	WRCS4-63-2436EP-5	126 lbs
24" x 48" x 69"	WRCS4-63-2448EP	131 lbs	WRCS4-63-2448EP-5	147 lbs
24" x 60" x 69"	WRCS4-63-2460EP	158 lbs	WRCS4-63-2460EP-5	179 lbs
74"H Post, 5" Stem Caster Cart with Solid Bottom Shelf and Enclosure Panels				
24" x 36" x 80"	WRCS4-74-2436EP	113 lbs	WRCS4-74-2436EP-5	126 lbs
24" x 48" x 80"	WRCS4-74-2448EP	131 lbs	WRCS4-74-2448EP-5	147 lbs
24" x 60" x 80"	WRCS4-74-2460EP	158 lbs	WRCS4-74-2460EP-5	179 lbs

DOLLY BASE 3 SIDED, 4 OR 5 WIRE SHELF CART WITH RODS & TABS

DIMENSIONS W" x L" x H"	4 SHELF CARTS		5 SHELF CARTS	
	MODEL NO.	SHIP WGT	MODEL NO.	SHIP WGT
63"H Post, 5" Stem Caster Cart with Solid Bottom Shelf and Enclosure Panels				
24" x 36" x 70"	WRDBS4-63-2436EP	124 lbs	WRDBS4-63-2436EP-5	137 lbs
24" x 48" x 70"	WRDBS4-63-2448EP	142 lbs	WRDBS4-63-2448EP-5	158 lbs
24" x 60" x 70"	WRDBS4-63-2460EP	169 lbs	WRDBS4-63-2460EP-5	190 lbs
74"H Post, 5" Stem Caster Cart with Solid Bottom Shelf and Enclosure Panels				
24" x 36" x 81"	WRDBS4-74-2436EP	124 lbs	WRDBS4-74-2436EP-5	137 lbs
24" x 48" x 81"	WRDBS4-74-2448EP	142 lbs	WRDBS4-74-2448EP-5	158 lbs
24" x 60" x 81"	WRDBS4-74-2460EP	169 lbs	WRDBS4-74-2460EP-5	190 lbs



Security Units

Stationary and Mobile Units prevent pilferage while allowing high visibility of contents at all times. All side and back panels are heavy gauge wire construction and are manufactured of all-welded heavy-duty 1/4" diameter wire on 2" x 2" centers. Assembly is quick and easy. **Finish:** Chrome

WANT TO SECURE YOUR EXISTING SHELVING UNITS?



2436-63SEC



M2436-69SEC



MD2436-70SEC

NYLON FABRIC OR CLEAR VINYL UNIT COVERS AVAILABLE

See [pg. 140](#)

Stationary Security Units

Intermediate shelves can be purchased separately, see [pg. 104](#). **Finish:** Chrome

Each unit consists of:

- 4 - posts
- 2 - wire shelves (for top and bottom)
- 1 - security panel set (includes back and sides)
- 1 - pair security panel doors

MODEL NO.	DIMENSIONS W" x L" x H"	SHIP WGT
Stationary Security Units		
2436-63SEC	24" x 36" x 63"	165 lbs
2448-63SEC	24" x 48" x 63"	192 lbs
2460-63SEC	24" x 60" x 63"	224 lbs

Security Panel Doors

Each door set has left and right panel with 4 hinge bars. Assembly is quick and easy and adapts to the appropriate shelf size, with our standard post of 63" in height.

MODEL NO.	DIMENSIONS W" x L" x H"	SHIP WGT
Security Panel Door Set with Hinges		
SD36C	24" x 36" x 60"	54 lbs
SD48C	24" x 48" x 60"	66 lbs
SD60C	24" x 60" x 60"	78 lbs

Security Panel Sets

Panels allow maximum security for standard shelving units. Panels are fabricated from all-welded wire and include joined back portion and two side portions.

MODEL NO.	DIMENSIONS W" x L" x H"	SHIP WGT
Security Enclosure Panel Set		
243660EPC	24" x 36" x 60"	70 lbs
244860EPC	24" x 48" x 60"	80 lbs
246060EPC	24" x 60" x 60"	90 lbs

Stem Caster Security Carts

Mobility adds flexibility to a unit and is beneficial in all types of operations. Intermediate shelves can be purchased separately, see [pg. 104](#). **Finish:** Chrome

Each unit consists of:

- 4 - posts
- 2 - wire shelves (for top and bottom)
- 1 - security panel set (includes back and sides)
- 1 - pair security panel doors

Mobile unit also includes:

- 4 - 5" poly stem casters, 2 with brake
- 4 - donut bumpers

MODEL NO.	DIMENSIONS W" x L" x H"	SHIP WGT
Stem Caster Security Carts		
M2436-69SEC	24" x 36" x 69"	173 lbs
M2448-69SEC	24" x 48" x 69"	200 lbs
M2460-69SEC	24" x 60" x 69"	232 lbs

Dolly Base Security Carts

Dollies can add stability and support in heavy-duty load applications. Intermediate shelves can be purchased separately, see [pg. 104](#). **Finish:** Chrome

Each unit consists of:

- 4 - posts
- 2 - wire shelves (for top and bottom)
- 1 - security panel set (includes back and sides)
- 1 - pair security panel doors

Dolly Base unit also includes:

- 1 - dolly base
- 4 - plate casters, 2 rigid and 2 swivel with brake

MODEL NO.	DIMENSIONS W" x L" x H"	SHIP WGT
Dolly Base Security Carts		
MD2436-70SEC	24" x 36" x 70"	186 lbs
MD2448-70SEC	24" x 48" x 70"	215 lbs
MD2460-70SEC	24" x 60" x 70"	250 lbs

High Density Sliding Floor Track System



High Density Sliding Track System offers a unique way to maximize and efficiently move wire shelving systems. The patented design allows for quick and easy installation. Bearings in the skate are located under each post for a load capacity of 1,500 lb. per shelving unit. The v-groove floor track allows the shelving unit to slide back and forth with ease. Layout assistance is available.

PERFORMANCE FEATURES AND BENEFITS

- Cuts construction costs
- Low shipping cost
- NSF approved
- Uses industrial bearings
- Corrosion free construction
- Easy to roll construction
- Fast installation
- Utilizes the structure of existing shelving
- Complies with ADA regulations
- 1,500 lb. load capacity per unit
- Can increase storage areas up to 150%



SYSTEMS SLIDE BACK AND FORTH WITH EASE

QESTP
End Stop Kit

Includes 2 ends and 1 drill bit. Serves the dual purpose of stopping a skate and is the anchor for the track. Manufactured from shock absorbing polymer. One kit is required per track.

QVTRK
V-Groove Track

Aluminum design with 304 stainless steel inserts with a gradual taper, non-tripping hazard, 7/16" max height. (Sold by the inch)

WK
Wing Kit

Includes two 1/4" thick aluminum plates & hardware and allows for the joining of 2 units side by side, sharing one track.

HD18 - HD36
One Skate

Aluminum with engineered plastic wheel housing and industrial 2,000 lb. bearings on each end.

MODEL NO.	DESCRIPTION	SHIP WGT
Sliding Track Skates		
HD18	One 18" Skate	4 lbs
HD21	One 21" Skate	5 lbs
HD24	One 24" Skate	6 lbs
HD30	One 30" Skate	7 lbs
HD36	One 36" Skate	8 lbs
Additional Components		
QESTP	End Stop Kit	1 lb
QVTRK	V-Track (Sold per inch)	1 lb
WK	Wing Kit	2 lbs

STEP BY STEP ORDERING INSTRUCTIONS:

(Note: Shelves and posts to be purchased separately on **pgs. 104-105**)

Step 1 - Select desired length (in inches) of track. Use **QVTRK** to order track.

(Note: single units require two tracks and double units will require three tracks)

Step 2 - Select corresponding skate size from the chart, which will be the same as the depth of shelving unit to be utilized. Two skates required per single unit and three skates required per double unit.

(Note: post height should not exceed a 4 to 1 ratio of skate size)

Step 3 - Purchase one End Stop Kit **QESTP** per track length.

For each double unit being used, a Wing Kit **WK** is required.



SINGLE UNIT TRACK SYSTEM
(Top View)

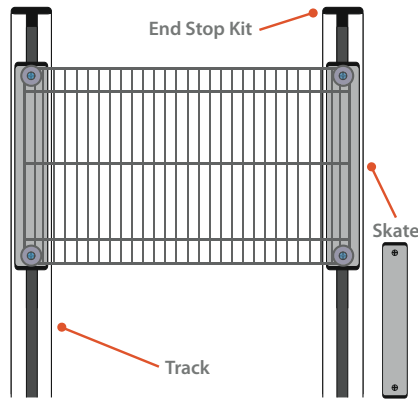

DOUBLE UNIT TRACK SYSTEM
(Top View)

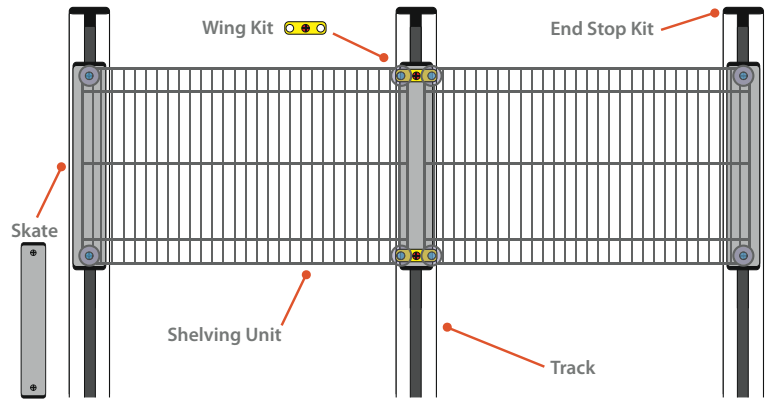

Single Unit Floor Track Assemblies

Assembly kit consists of a pair of aluminum tracks with end stop kits. Hardware and assembly instructions included. (Note: custom lengths may be purchased, see pg. 146)

MODEL NO.	TRACK L' (FT)	TRACK L" (IN)	SHIP WGT
Single Unit Floor Track Assembly Kit Includes 2 Tracks of Specified Length with End Stop Kits			
QVTRK-2-72EST	6'	72"	14 lbs
QVTRK-2-84EST	7'	84"	16 lbs
QVTRK-2-96EST	8'	96"	18 lbs
QVTRK-2-108EST	9'	108"	20 lbs
QVTRK-2-120EST	10'	120"	22 lbs
QVTRK-2-132EST	11'	132"	24 lbs
QVTRK-2-144EST	12'	144"	26 lbs
QVTRK-2-156EST	13'	156"	28 lbs
QVTRK-2-168EST	14'	168"	30 lbs
QVTRK-2-180EST	15'	180"	32 lbs
QVTRK-2-192EST	16'	192"	34 lbs
QVTRK-2-204EST	17'	204"	36 lbs
QVTRK-2-216EST	18'	216"	38 lbs
QVTRK-2-228EST	19'	228"	40 lbs
QVTRK-2-240EST	20'	240"	42 lbs

Single Unit Skate Assembly Kits

Each kit includes two skates and all appropriate hardware. One kit is required for each single mobile unit. (Shelves and posts sold separately on pgs. 104 & 105)

MODEL NO.	DESCRIPTION	SHIP WGT
Single Unit Skate Assembly Kits		
HD18-2	Two 18" Skates	8 lbs
HD21-2	Two 21" Skates	10 lbs
HD24-2	Two 24" Skates	12 lbs
HD30-2	Two 30" Skates	14 lbs
HD36-2	Two 36" Skates	16 lbs

Double Unit Floor Track Assemblies

Each assembly kit consists of three aluminum tracks with end stop kits. Hardware and assembly instructions included. (Note: custom lengths may be purchased, see pg. 146)

MODEL NO.	TRACK L' (FT)	TRACK L" (IN)	SHIP WGT
Double Unit Floor Track Assembly Kit Includes 3 Tracks of Specified Length with End Stop Kits			
QVTRK-3-72EST	6'	72"	21 lbs
QVTRK-3-84EST	7'	84"	24 lbs
QVTRK-3-96EST	8'	96"	27 lbs
QVTRK-3-108EST	9'	108"	30 lbs
QVTRK-3-120EST	10'	120"	33 lbs
QVTRK-3-132EST	11'	132"	36 lbs
QVTRK-3-144EST	12'	144"	39 lbs
QVTRK-3-156EST	13'	156"	42 lbs
QVTRK-3-168EST	14'	168"	45 lbs
QVTRK-3-180EST	15'	180"	48 lbs
QVTRK-3-192EST	16'	192"	51 lbs
QVTRK-3-204EST	17'	204"	54 lbs
QVTRK-3-216EST	18'	216"	57 lbs
QVTRK-3-228EST	19'	228"	60 lbs
QVTRK-3-240EST	20'	240"	63 lbs

Double Unit Skate Assembly Kits

Each kit includes three skates and all appropriate hardware. One kit is required for each double mobile unit. (Shelves and posts sold separately on pgs. 104 & 105)

MODEL NO.	DESCRIPTION	SHIP WGT
Double Unit Skate Assembly Kits		
HD18-3	Three 18" Skates + Wing Kit	15 lbs
HD21-3	Three 21" Skates + Wing Kit	18 lbs
HD24-3	Three 24" Skates + Wing Kit	21 lbs
HD30-3	Three 30" Skates + Wing Kit	24 lbs
HD36-3	Three 36" Skates + Wing Kit	27 lbs

STEP BY STEP ORDERING INSTRUCTIONS:

- Select desired length of track and if you require:
 - Single Unit track (use charts on left)
 - Double Unit track (use charts on right)
- Select corresponding skate size from single or double unit charts below. Skate size should match the depth of shelving unit being utilized.
- Using the chart on the bottom of this page, determine how many shelving units will fit on your track.
- Pre-configured 4 and 5 shelf wire units are available on pgs. 106-109. Additional intermediate shelves are available on pg. 104.

QUANTITY OF SHELVING UNITS BY WIDTH TO FIT ON LENGTH OF TRACK*

	6'	7'	8'	9'	10'	11'	12'	13'	14'	15'	16'	17'	18'	19'	20'
18"	2	2	3	4	4	5	6	6	7	8	8	9	10	10	11
21"	1	2	2	3	4	4	5	5	6	6	7	8	8	9	9
24"	1	2	2	3	3	4	4	5	5	6	6	7	7	8	8
30"	1	1	2	2	2	3	3	4	4	4	5	5	6	6	6
36"	1	1	1	2	2	2	3	3	3	4	4	4	5	5	5

* Using a minimum 36" aisle space. Note, post height should not exceed the skate length by a 4 to 1 ration (example 18" skate should not exceed a 74" post)



Sliding Overhead Track System



Quantum's new Overhead Track wire shelving system provides maximum storage using a minimum of space. All kits include all necessary sections of track for assembling lengths that range from 8' to 21' (note: shelves and posts sold separately). Assembly is quick and easy and the whole system requires only single-aisle access. Casters are 5" x 1-1/4" rigid polyurethane. Overhead Track design provides a clear walkway and clear aisles underneath eliminating any tripping hazard. Overhead Track extrusion manufactured of heavy-duty aluminum ensuring years of heavy-duty and reliable service.

PERFORMANCE FEATURES AND BENEFITS

- NSF approved
- Uses industrial bearings
- Corrosion free construction
- Easy to roll construction
- Fast installation
- Utilizes the structure of existing shelving
- 1,200 lb. load capacity per unit
- Can increase storage areas up to 150%

MODEL NO.	DESCRIPTION	SHIP WGT
Overhead Track		
TK-2	One Track - 2 Feet	7 lbs
TK-26	One Track - 2-1/2 Feet	9 lbs
TK-5	One Track - 5 Feet	17 lbs
TK-6	One Track - 6 Feet	21 lbs
TK-7	One Track - 7 Feet	24 lbs
TK-EP	Track End Plates with Hardware (Set of 4)	1 lb
TK-CA	Track Connector with Hardware (Set of 4)	6 lbs
End Unit Single Sided Track Bracket Pair		
TK-STB18	18" Single Overhead Track Bracket Pair	4 lbs
TK-STB21	21" Single Overhead Track Bracket Pair	5 lbs
TK-STB24	24" Single Overhead Track Bracket Pair	6 lbs
Intermediate Unit Double Sided Track Bracket Pair		
TK-DTB18	18" Double Overhead Track Bracket Pair	4 lbs
TK-DTB21	21" Double Overhead Track Bracket Pair	5 lbs
TK-DTB24	24" Double Overhead Track Bracket Pair	6 lbs
Mobile Unit Track Rollers		
TK-CBW	Set of 4 Track Rollers	2 lbs



INCREASE STORAGE AREAS UP TO 150%



LOWEST PRICE GUARANTEED!



NEW

STATIONARY END KIT
(Shelves sold separately)



NEW

INTERMEDIATE KIT
(Shelves sold separately)



NEW

MOBILE KIT
(Shelves sold separately)

STEP BY STEP ORDERING INSTRUCTIONS:

- Step 1 - Select desired length of track.
- Step 2 - Select corresponding stationary end kit and intermediate kits from charts. Size should match the depth of shelving unit being utilized.
- Step 3 - Using the chart on the bottom of this page, determine how many Mobile Kits will fit on your track.
- Step 4 - Wire shelves are available on **pg. 104**.

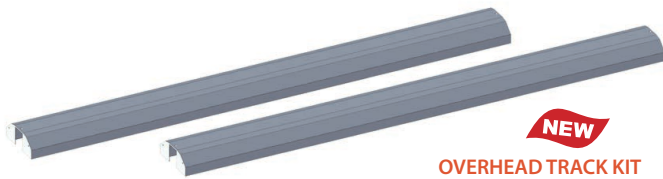

NEW

OVERHEAD TRACK KIT

Overhead Track Kits



Each kit includes two track of the same length and end plates.

MODEL NO.	TRACK L' (FT)	TRACK L" (IN)	SHIP WGT
Overhead Track Kit			
TTK-8	8'	96"	53 lbs
TTK-9	9'	108"	60 lbs
TTK-10	10'	120"	67 lbs
TTK-11	11'	132"	73 lbs
TTK-12	12'	144"	80 lbs
TTK-13	13'	156"	87 lbs
TTK-14	14'	168"	93 lbs
TTK-15	15'	180"	100 lbs
TTK-16	16'	192"	107 lbs
TTK-17	17'	204"	113 lbs
TTK-18	18'	216"	120 lbs
TTK-19	19'	228"	127 lbs
TTK-20	20'	240"	133 lbs
TTK-21	21'	252"	140 lbs

Stationary End Kits



Unit consists of:

- 8 - 86" Posts
- 8 - Foot plates
- 4 - Single sided overhead track support brackets

MODEL NO.	DESCRIPTION	SHIP WGT
TTK-E18	18" Stationary End Kits	64 lbs
TTK-E21	21" Stationary End Kits	72 lbs
TTK-E24	24" Stationary End Kits	80 lbs

Intermediate Kits



Unit consists of:

- 4 - 86" Posts
- 4 - Foot plates
- 2 - Double sided overhead track support brackets

MODEL NO.	DESCRIPTION	SHIP WGT
TTK-C18	18" Intermediate Kits	32 lbs
TTK-C21	21" Intermediate Kits	36 lbs
TTK-C24	24" Intermediate Kits	40 lbs

Mobile Kits



Unit consists of:

- 4 - 74" Posts
- 4 - Track rollers
- 2 - Tie bars
- 4 - Rigid casters
- 4 - Donut bumpers

MODEL NO.	DESCRIPTION	SHIP WGT
TTK-M18	18" Mobile Kit	34 lbs
TTK-M21	21" Mobile Kit	36 lbs
TTK-M24	24" Mobile Kit	38 lbs

QUANTITY OF SHELVING UNITS BY WIDTH TO FIT ON LENGTH OF TRACK*

	8'	9'	10'	11'	12'	13'	14'	15'	16'	17'	18'	19'	20'	21'
18"	3	3	4	4	5	6	6	7	7	8	9	9	10	10
21"	2	3	3	4	4	5	5	6	6	7	7	8	8	9
24"	2	2	3	3	4	4	5	5	6	6	6	7	7	8

* Using a minimum 36" aisle space.

Modular Enclosure Panels

Are easily adaptable to standard shelving units to create a secured storage area.

- Panels are fabricated from 6 gauge wire on 3" x 3" squares
- Modular enclosure panels work with four shelf depths: 14", 18", 21" and 24" and three heights: 63", 74" and 86"
- One modular enclosure panel is needed for each side and two or three panels are needed for the back

CHROME	STAINLESS STEEL		
MODEL NO.	MODEL NO.	DESCRIPTION	SHIP WGT
EP126	EP126S	One 12" x 62" Enclosure Panel	5 lbs
EP166	EP166S	One 16" x 62" Enclosure Panel	6 lbs
EP196	EP196S	One 19" x 62" Enclosure Panel	7 lbs
EP226	EP226S	One 22" x 62" Enclosure Panel	8 lbs
EP127	EP127S	One 12" x 73" Enclosure Panel	6 lbs
EP167	EP167S	One 16" x 73" Enclosure Panel	7 lbs
EP197	EP197S	One 19" x 73" Enclosure Panel	8 lbs
EP227	EP227S	One 22" x 73" Enclosure Panel	9 lbs
EP128	EP128S	One 12" x 84" Enclosure Panel	7 lbs
EP168	EP168S	One 16" x 84" Enclosure Panel	8 lbs
EP198	EP198S	One 19" x 84" Enclosure Panel	9 lbs
EP228	EP228S	One 22" x 84" Enclosure Panel	10 lbs



MOBILE LINEN CART
SHOWN WITH 4 ENCLOSURE PANELS.
MOBILE LINEN CARTS AVAILABLE
See *pgs. 142 & 144*



Collar Hooks

SCH1

Used to secure baskets to posts or as a hook for cables. Sold in packs of four.

MODEL NO.	DESCRIPTION	SHIP WGT
SCH1-5	1-1/2" Hook	1 lb
SCH1	1/2" Hook	1 lb

Single and Double Drawer Slides

Compliment any system with specialized areas for storage which allow bins and trays to be suspended between shelves. Single bin slide mounts 18", 21" and 24" shelves. Double bin slide adapts to 24" shelves only. (*Bins sold separately*).

MODEL NO.	DESCRIPTION	SHIP WGT
DS18-24	Single Bin Design	2 lbs
DDS-24	Double Bin Design	4 lbs



Modular Dolly Frames

Dolly Frames allow standard shelving units to be converted to heavy-duty transport trucks. Frames are fabricated from heavy gauge steel. Bumpers are attached to each corner to protect walls and help cushion impact. **Finishes:** Chrome & Stainless Steel (*Plate casters sold separately*)

CHROME	STAINLESS STEEL		
MODEL NO.	MODEL NO.	DIMENSIONS W" x L"	SHIP WGT
DB1836C	DB1836S	18" x 36"	10 lbs
DB1848C	DB1848S	18" x 48"	12 lbs
DB1860C	DB1860S	18" x 60"	14 lbs
DB2436C	DB2436S	24" x 36"	13 lbs
DB2448C	DB2448S	24" x 48"	15 lbs
DB2460C	DB2460S	24" x 60"	18 lbs

CHOOSE FROM ONE BIN / TRAY DESIGN OR TWO BIN / TRAY DESIGN



Label Holders

Are an excellent method for identifying product. Affix directly to truss on any size shelf.

MODEL NO.	DESCRIPTION	SHIP WGT
LH3B	3" Gray Label Holder	1 lb
LH3C	3" Clear Label Holder	1 lb
LH12C	12" Clear Label Holder	1 lb
LH24C	24" Clear Label Holder	1 lb
Full Length Label Holders		
LH33C	33" Clear Label Holder Fits 36" Shelf	1 lb
LH39C	39" Clear Label Holder Fits 42" Shelf	1 lb
LH45C	45" Clear Label Holder Fits 40" Shelf	1 lb
LH51C	51" Clear Label Holder Fits 54" Shelf	2 lbs
LH57C	57" Clear Label Holder Fits 60" Shelf	2 lbs
LH69C	69" Clear Label Holder Fits 72" Shelf	2 lbs
Angled Label Holders - 30°, 60° and 90°		
LHA3C	3" Angled Clear Label Holder	1 lb
LHA5C	5" Angled Clear Label Holder	1 lb
LHA24C	24" Angled Clear Label Holder	1 lb
Laser & Inkjet Label Inserts - 48 Labels		
LHI-3	1-1/4" x 3" Label Inserts	2 lbs
LHI-6	1-1/4" x 6" Label Inserts	2 lbs



LHA3C Top Shelf View



LHA3C Bottom Shelf View



Push Handles

Comfortable grip design. Five widths available enabling easy movement of any mobile unit. **Finishes:** Chrome, Stainless Steel and Black

CHROME	STAINLESS STEEL	BLACK	NEW	
MODEL NO.	MODEL NO.	MODEL NO.	DESCRIPTION	SHIP WGT
PH18	PH18S	PH18BK	One 18" Push Handle	2 lbs
PH21	PH21S	-	One 21" Push Handle	3 lbs
PH24	PH24S	PH24BK	One 24" Push Handle	3 lbs
PH30	PH30S*	-	One 30" Push Handle	3 lbs
PH36	PH36S	-	One 36" Push Handle	3 lbs

* Special order. Minimum quantity and extended lead time may apply. Please call for details.



U-Handles

Build your own special size utility cart with three different width choices: 18", 21" or 24". Overall height 32", not including casters. **Finishes:** Chrome, Stainless Steel and Black

CHROME	STAINLESS STEEL	BLACK	NEW	
MODEL NO.	MODEL NO.	MODEL NO.	DESCRIPTION	SHIP WGT
UH18	UH18S	UH18BK	18" U-Handle	2 lbs
UH21	UH21S	-	21" U-Handle	3 lbs
UH24	UH24S	UH24BK	24" U-Handle	3 lbs



Shelf Inlay Mats

An economical solution to convert a wire shelf to a solid surface preventing items from falling through. White shelf inlay mat is easily removable for cleaning. Manufactured of polyethylene.

MODEL NO.	DESCRIPTION	SHIP WGT
1836SM	One 18" x 36" Inlay Mat	1 lb
1848SM	One 18" x 48" Inlay Mat	2 lbs
1860SM	One 18" x 60" Inlay Mat	2 lbs
1872SM	One 18" x 72" Inlay Mat	2 lbs
2436SM	One 24" x 36" Inlay Mat	2 lbs
2448SM	One 24" x 48" Inlay Mat	2 lbs
2460SM	One 24" x 60" Inlay Mat	2 lbs
2472SM	One 24" x 72" Inlay Mat	3 lbs



Tie Bars

Required with rigid casters to ensure rigid alignment. Tie bar length should match up to shelf depth. Rigid casters sold separately. **Finish:** Chrome

MODEL NO.	DESCRIPTION	SHIP WGT
18TB	One 18" Tie Bar which fits 2 casters	2 lbs
21TB	One 21" Tie Bar which fits 2 casters	2 lbs
24TB	One 24" Tie Bar which fits 2 casters	2 lbs
30TB	One 30" Tie Bar which fits 2 casters	2 lbs
36TB	One 36" Tie Bar which fits 2 casters	3 lbs



Side and Back Ledges

Ledges are 4"H and act as a perimeter to retain shelf items and prevent anything from falling off. **Finishes:** Chrome, Stainless Steel and Black

CHROME	STAINLESS STEEL	BLACK	NEW	
MODEL NO.	MODEL NO.	MODEL NO.	DESCRIPTION	SHIP WGT
4"H Side Ledges				
SL12	SL12S	SL12BK	12" Side Ledge	1 lb
SL14	SL14S	-	14" Side Ledge	1 lb
SL18	SL18S	SL18BK	18" Side Ledge	1 lb
SL21	SL21S	-	21" Side Ledge	2 lbs
SL24	SL24S	SL24BK	24" Side Ledge	2 lbs
SL30	SL30S	-	30" Side/Back Ledge	2 lbs
4"H Back Ledges				
BL36	BL36S	BL36BK	36" Back/Side Ledge	3 lbs
BL42	BL42S	-	42" Back Ledge	3 lbs
BL48	BL48S	BL48BK	48" Back Ledge	3 lbs
BL54	BL54S	-	54" Back Ledge	4 lbs
BL60	BL60S	BL60BK	60" Back Ledge	5 lbs
BL72	BL72S	BL72BK	72" Back Ledge	6 lbs

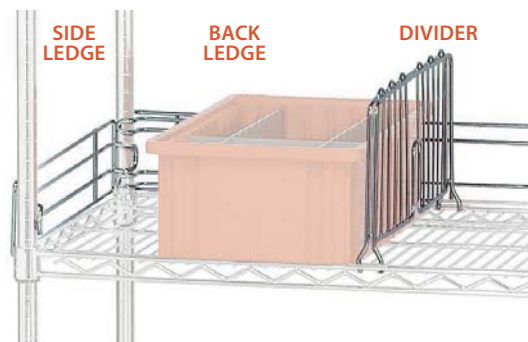

Dividers

Dividers are 8"H and are available in 7 depths to be used with all shelves. **Finishes:** Chrome, Stainless Steel and Black

CHROME	STAINLESS STEEL	BLACK		
MODEL NO.	MODEL NO.	MODEL NO.	DESCRIPTION	SHIP WGT
Dividers				
DIV12	DIV12S	DIV12BK	One 12" Divider	2 lbs
DIV14	DIV14S	-	One 14" Divider	2 lbs
DIV18	DIV18S	DIV18BK	One 18" Divider	2 lbs
DIV21	DIV21S	-	One 21" Divider	3 lbs
DIV24	DIV24S	DIV24BK	One 24" Divider	3 lbs
DIV30	DIV30S	-	One 30" Divider	4 lbs
DIV36	DIV36S	DIV36BK	One 36" Divider	4 lbs

Post Clamps

Joins multiple units of shelving.

MODEL NO.	DESCRIPTION	SHIP WGT
PCL1	1/2" Post Clamp	4 lbs
PCL2	3-1/3" Post Clamp	5 lbs



Hang Bars

MODEL NO.	DESCRIPTION	SHIP WGT
GR24	One 24" Hang Bar	2 lbs
GR36	One 36" Hang Bar	3 lbs
GR48	One 48" Hang Bar	4 lbs
GR60	One 60" Hang Bar	5 lbs



HANG BAR

S-Hooks

For continuous runs of shelving. Two hooks should be placed per shelf where two posts are not utilized. Sold as an 8 pack.

Finishes: Chrome, Stainless Steel, Proform and Black



-  **S-HOOK**
Chrome
-  **S-HOOKSS**
Stainless Steel
-  **S-HOOKP**
Proform
-  **S-HOOKBK**
Black



KEYBD
Keyboard Shelf

Mounts under any size wire shelf and accepts keyboards up to 21"W x 11"D. Has a 6" height adjustment. Measures 25-1/4"W x 15"D x 4-1/4"H



UB10
Utility Basket

An additional storage or display area outside the perimeter of the shelf. Measures 11-1/4" x 18-7/8" x 7-5/8"H

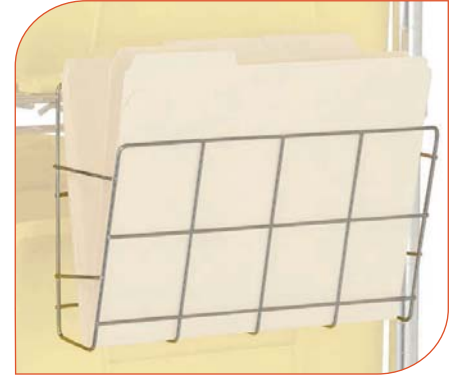

DH8
Document Holder

Provides an effective way to secure documents or folders. Measures 12-3/8" x 2" x 8-5/8"H

Conductive Options



WR-SSCO
Plastic Conductive Split Sleeve
Sold as a pack of 4 pairs.



ESD-SS
Aluminum Split Sleeve
Aluminum Split Sleeves required when grounding standard wire shelving in conductive applications.



ESD-DC
Drag Chain
Drag chain is mounted to bottom of shelf and is used to ground standard wire shelving units. Recommended to be used in conjunction with aluminum or plastic conductive split sleeves.



FP
Foot Plate
Triangular plate allows additional surface to disperse weight.



FG
Non-Marring Floor Glides
Serves as protection to prevent marring of floors. Sold as a 4 pack.



WR-SS
Split Sleeve
Sold as a pack of 4 pairs.



WR-SP
Shelf Collar Plug
Sold as a pack of 4 pieces.



WR-WMB
Post Wall Mount Bracket
Mounts post to wall securely. 2" clearance required.



LOWEST PRICE GUARANTEED!

ADD YOUR CASTER KIT TO YOUR UNIT FOR MOBILITY

Donut Bumper



Non-marking, 3" diameter plastic bumper used to protect walls and help cushion impact.

MODEL NO.	DESCRIPTION	SHIP WGT
DB	One 3" Diameter Donut Bumper	1 lb

Casters

MODEL NO.	DESCRIPTION	LOAD CAPACITY PER CASTER	SHIP WGT
Stem Casters			
WR-00H	Four Swivel 5" x 1-1/4" Polyurethane Casters, 2 with brake	300 lbs	10 lbs
WR-00HS	Four Swivel 5" x 1-1/4" Polyurethane Stainless Steel Casters with Zerk Grease Fittings, 2 with brake	300 lbs	12 lbs
WR-00CO	Four Swivel ESD/Conductive 5" x 1-1/4" Casters, 2 with brake	300 lbs	12 lbs
WR-SB2R2*	Two Swivel 5" x 1-1/4" Polyurethane Caster with brake, 2 Rigid	300 lbs	12 lbs
WR-3	Four Swivel 3" Polyurethane Casters, all with brake	200 lbs	8 lbs
WR-RG*	One Rigid 5" x 1-1/4" Polyurethane Caster	300 lbs	3 lbs
WR-PS	One Swivel 8" x 2-1/2" Pneumatic Caster	325 lbs	4 lbs
Plate Casters			
PT-PS	One Swivel 5" x 1-1/4" Polyurethane Caster	300 lbs	3 lbs
PT-PR	One Rigid 5" x 1-1/4" Polyurethane Caster	300 lbs	3 lbs
PT-PSB	One Swivel 5" x 1-1/4" Polyurethane Caster with brake	300 lbs	3 lbs
PT-PS-S	One Swivel 5" x 1-1/4" Polyurethane Stainless Steel Caster with Zerk Grease Fittings	300 lbs	3 lbs
PT-PR-S	One Rigid 5" x 1-1/4" Polyurethane Stainless Steel Caster with Zerk Grease Fittings	300 lbs	3 lbs
PT-PSB-S	One Swivel 5" x 1-1/4" Polyurethane Stainless Steel Caster with brake with Zerk Grease Fittings	300 lbs	3 lbs
PT-PS6	One Swivel 6" x 2" Polyurethane Caster	800 lbs	5 lbs
PT-PR6	One Rigid 6" x 2" Polyurethane Caster	800 lbs	5 lbs
PT-PSB6	One Swivel 6" x 2" Polyurethane Caster with brake	800 lbs	5 lbs
PT-NS	One Swivel 8" x 2-1/2" Pneumatic Caster	325 lbs	4 lbs
PT-NR	One Rigid 8" x 2-1/2" Pneumatic Caster	325 lbs	4 lbs

* Requires Tie Bar for rigid alignment (See pg. 151)



WR-00H
Shown with and without brake
Sold as a set of 4 casters, 2 with brake



WR-00CO
Shown with and without brake
Sold as a set of 4 casters, 2 with brake



WR-00HS
Shown with and without brake
Sold as a set of 4 casters, 2 with brake



PT-PR



PT-PS



PT-PSB



PT-PR6



PT-PS6



PT-PSB6



WR-3
Sold as a set of 4 casters, all with brake



WR-PS



PT-NR



PT-NS



WR-RG
Requires Tie Bar
(See chart pg. 151)

Hamper

Single bag hamper offers foot activated ABS heavy-duty lid for quick accessibility. Double ring bag holder allows for quick bag insertion and bag lock. Supports 36-42 gallon multi-purpose bags with a ring to keep bag in place. Four 3" casters (2 with brake) allows for easy mobility. **Finish:** Chrome

MODEL NO.	DIMENSIONS W" x L" x H"	SHIP WGT
18-M-HAMP	20" x 18" x 38"	21 lbs



Sterile Wrap Carts

Hang bars keep sterile wraps separated and accessible for special preps. Bars are easy to adjust. Neoprene gaskets hold wraps in position. Two designs to choose from: cascading or flat surface. **Finish:** Chrome

MODEL NO.	DIMENSIONS W" x L" x H"	SHIP WGT
Cascading Sterile Wrap Cart		
WRC-SW2448	24" x 48" x 69"	103 lbs
Low Profile, Sterile Wrap Cart		
WRC-LPSW1863	18" x 63" x 39-1/2"	46 lbs

TWO DESIGNS AVAILABLE



WRC-LPSW1863



WRC-SW2448



WRSC3-42-2436FS
24"W x 36"L x 48"H



WRSC4-54-2436FS
24"W x 36"L x 60"H



SST-2436U
24"W x 36"L x 34"H

Adjustable
from 3" - 27"
under top shelf

Open Surgical Case Carts

Corrosion-free surgical case cart transports and delivers surgical instrumentation packs from the OR supply center to the operating room. **Finish:** 304 Stainless Steel

3 Sided Frame

Finish: 304 Stainless Steel

STAINLESS MODEL NO.	DIMENSIONS W" x L"	SHIP WGT
2436FS	24" x 36"	8 lbs
2448FS	24" x 48"	9 lbs
2460FS	24" x 60"	10 lbs

Each unit consists of:

- 4 - 42" stainless steel posts
- 2 - stainless steel wire shelves
- 1 - stainless steel solid shelf
- 1 - stainless steel 3-sided frame
- 1 - stainless steel push handle
- 4 - 5" swivel, stainless steel poly stem casters and 2 with brake (casters come with Zerk grease fittings)
- 4 - donut bumpers

MODEL NO.	DIMENSIONS W" x L" x H"	NO. OF SHELVES	SHIP WGT
WRSC3-42-2436FS	24" x 36" x 48"	3	77 lbs
WRSC3-42-2448FS	24" x 48" x 48"	3	88 lbs
WRSC3-42-2460FS	24" x 60" x 48"	3	106 lbs

Each unit consists of:

- 4 - 54" stainless steel posts
- 3 - stainless steel wire shelves
- 1 - stainless steel solid shelf
- 1 - stainless steel 3-sided frame
- 1 - stainless steel push handle
- 4 - 5" swivel, stainless steel poly stem casters and 2 with brake (casters come with Zerk grease fittings)
- 4 - donut bumpers

MODEL NO.	DIMENSIONS W" x L" x H"	NO. OF SHELVES	SHIP WGT
WRSC4-54-2436FS	24" x 36" x 60"	4	94 lbs
WRSC4-54-2448FS	24" x 48" x 60"	4	108 lbs
WRSC4-54-2460FS	24" x 60" x 60"	4	131 lbs

Stainless Steel Work Table with Adjustable Undershaft



Heavy-duty 304 stainless steel processing tables are ideal for pack and prep in sterile environments. Units consist of a flat top work surface with hemmed edges and the lower flat bottom shelf is adjustable from 3" to 27" high. Tables are NSF approved. The support legs are 1-5/8" diameter with a leveling foot which can be converted to a mobile unit with a 3" conductive caster kit, all swivel and 2 with brake. (Sold separately) **Finish:** 304 Stainless Steel

MODEL NO.	DIMENSIONS W" x L" x H"	NO. OF SHELVES	SHIP WGT
Stationary Instrument Table with Shelf			
SST-2436U	24" x 36" x 34"	1	50 lbs
SST-2448U	24" x 48" x 34"	1	60 lbs
SST-2460U	24" x 60" x 34"	1	70 lbs
SST-2472U	24" x 72" x 34"	1	80 lbs
Mobile Kit			
SST-MOB	4 Swivel Casters, 2 with Brakes		4 lbs

Catheter Cart - Complete with Bins

Uniquely designed, the catheter bin cart replaces the wire basket concept with color coded bins allowing for quicker identification. The combination of modular wire and plastic bins minimizes shrinkage and reduces unit cost. Bins are molded from high density polypropylene and are available in 7 colors. **Cart Finish:** Chrome

Available in: ● Blue ● Green ● Ivory ● Red ● Yellow ● Black ● Clear

MODEL NO.	BIN DIMENSIONS L" x W" x H"	SHIP WGT
24" x 48" x 69" Wire Catheter Cart with 9 Wire Shelves Complete with 80 QSB105 Bins		
WRC9-63-2448-105	23-5/8" x 4-1/8" x 4"	246 lbs



WRC9-63-2448-105



MOBILIZE YOUR WIRE SHELVING

DB - Donut Bumper

Non-marking donut bumper used to protect walls and help cushion impact.

WR-00H (Mobile Kit)*

Set of four swivel polyurethane 5" x 1-1/4" casters, two with brakes. Can be used with all units shown. 1,200 lb. load capacity.



Catheter Hooks

Package includes 6 catheter hooks.
Finish: Chrome

MODEL NO.	DESCRIPTION	CTN WGT
Catheter Hooks - 6 Pack		
WR-CH	6 Catheter Hooks	2 lbs

Catheter Hold and Store Cart

The catheter hold and store cart allows separation and easy accessibility to pre-packed catheters. Ideal for central or OR supply centers, this style cart is modular in design. Includes 32 catheter hooks. **Finish:** Chrome

MODEL NO.	DIMENSIONS W" x L" x H"	SHIP WGT
Catheter Hold & Store Cart Includes 32 Catheter Hooks		
WRC-BC2448	24" x 48" x 69"	105 lbs



WRC-BC2448

Shown with Dividable Grid Containers Sold separately on **pg. 67**



LOWEST PRICE GUARANTEED!



WRCGR-63-2436



RACK & CART COVERS
Protect against pilferage, airborne dust, moisture and other contaminants.

Stationary and Mobile Wire Garment Racks

Ideal storage rack for hanging any type of coat or garment. Includes handy bottom shelf for additional storage.

Finish: Chrome

Each unit consists of:

- 4 - 63" posts
- 2 - wire shelves
- 1 - hang bar

Mobile unit also includes:

- 4 - 5" swivel poly stem casters, 2 with brakes
- 4 - donut bumpers

MODEL NO.	NO. OF SHELVES	DIMENSIONS W" x L" x H"	SHIP WGT
Stationary Wire Garment Racks			
WRGR-63-2436	2	24" x 36" x 63"	45 lbs
WRGR-63-2448	2	24" x 48" x 63"	52 lbs
WRGR-63-2460	2	24" x 60" x 63"	63 lbs
Mobile Wire Garment Racks			
WRCGR-63-2436	2	24" x 36" x 69"	59 lbs
WRCGR-63-2448	2	24" x 48" x 69"	66 lbs
WRCGR-63-2460	2	24" x 60" x 69"	77 lbs

NYLON FABRIC OR CLEAR VINYL RACK & CART COVERS AVAILABLE

See **pg. 140**



WRCPL-63-2460

COMPLETE CART INCLUDES CASTER KIT FOR MOBILITY

Patient Apparel Cart

Ideal for patient care situations where the distribution and holding of apparel is required. The horizontal bar accommodates hangers and the shelves are divided into separate visible compartments. **Finish:** Chrome

Each unit consists of:

- 4 - 63" posts
- 2 - 54" posts
- 2 - 24" x 60" wire shelves
- 3 - 24" x 36" wire shelves
- 8 - 24" dividers
- 2 - 61" rods & tabs kits
- 1 - 24" hang bar
- 4 - 5" swivel poly stem casters, 2 with brakes
- 4 - donut bumpers

MODEL NO.	NO. OF SHELVES	DIMENSIONS L" x W" x H"	SHIP WGT
WRCPL-63-2460	5	24" x 60" x 69"	146 lbs

Bin Transport Cart

The combination of bins and modular shelving creates a highly efficient method of visually identifying and transporting multiple items. The large capacity bins allow for color coding and the rotation of inventories. This multi-tasked unit is excellent for a wide variety of applications and transport solutions. Bins are available in 4 colors. **Cart Finish:** Chrome

Each unit consists of:

- 4 - 63" posts
- 2 - 54" posts
- 2 - 24" x 60" wire shelves
- 3 - 24" x 36" wire shelves
- 4 - 5" swivel poly stem casters, 2 with brakes
- 4 - donut bumpers
- 4 - **QUS955** (23-7/8" x 18-1/4" x 12")

Available in: ● Blue ● Red ● Yellow ● Clear

MODEL NO.	DIMENSIONS W" x L" x H"	NO. OF BINS	SHIP WGT
WRCPL-63-2460-955	24" x 60" x 69"	4 QUS955	165 lbs

COMPLETE PACKAGES WITH BINS

Bin Transport Cart

Modular in design, the Bin Transport Cart provides an integrated system to transfer items. Carts enable you to color code, hold or transport inventories and supplies. Ideal for use in central supply and laundry. Bins are autoclavable up to 250°F. Bins are available in 3 colors. **Cart Finish:** Chrome

Available in: ● Blue ● Red ● Yellow

MODEL NO.	NO. OF SHELVES	NO. OF BINS	BIN DIMENSIONS L" x W" x H"	SHIP WGT
30" x 36" x 69" Wire Shelving Unit with HULK Containers				
WRC2-63-3036-974976	2	2	29-7/8" x 16-1/2" x 11"	150 lbs
		6	29-7/8" x 16-1/2" x 15"	
30" x 36" x 42" Wire Shelving Unit with HULK Containers				
WRC2-36-3036-976	2	4	29-7/8" x 16-1/2" x 15"	88 lbs



WRCPL-63-2460-955



WRC2-36-3036-976



WRC2-63-3036-974976

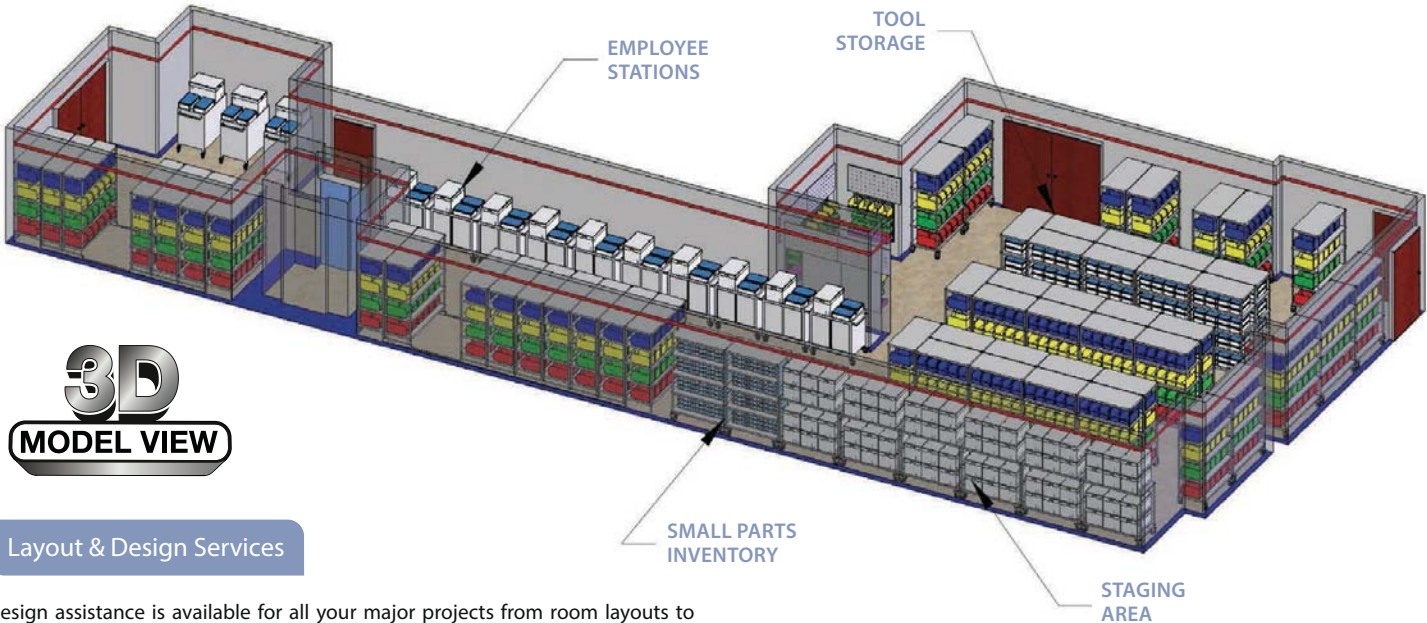

3D MODEL VIEW

Layout & Design Services

Design assistance is available for all your major projects from room layouts to shelving or cart design. We'll create and develop an integrated system around your requirements. Layouts can be created to accommodate your space with the appropriate product mix consisting of:

- Wire Shelving
- Stationary Shelving
- Bins
- Wall Systems
- Baskets
- Containers
- Hi-Density Mobile Track Systems

TO ACHIEVE THE BEST RESULTS, PLEASE PROVIDE THE FOLLOWING INFORMATION:

- Room dimensions with door locations and door clearances, column locations (L x W) and ceiling height
- For shelving units, provide the number of shelf tiers, post height and indicate stationary or mobile
- If bins are required, indicate the appropriate size and whether they are to be used on shelving or wall mounted louvered panels

Quantum Storage offers the most complete package of storage products to satisfy all your requirements. Let us review your next project to maximize your storage space.

- Industry Exclusive 3D Modeling
- Blueprint & AutoCAD Compatible
- Space Utilization & Maximization
- Plan-o-grams



DESIGN ASSISTANCE AVAILABLE

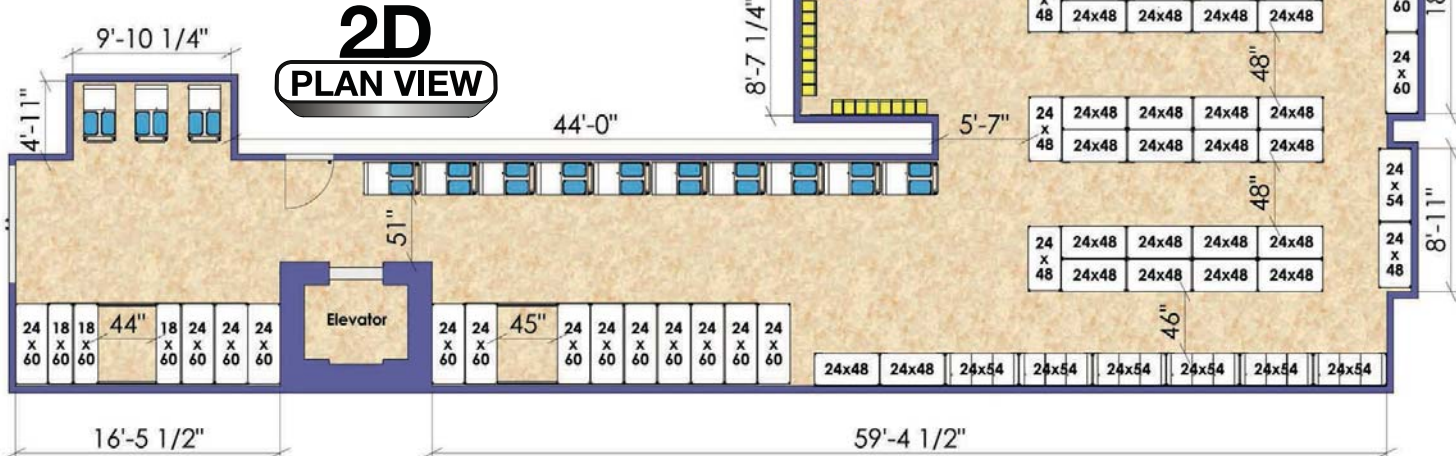

2D PLAN VIEW

MODEL NO	PG.	1436SS - 1472SS..... 105	1875-210..... 56	AD18G-75-1236-5.....	BL36BK - BL72BK..... 151	DDC91000CL - DDC93000CL... 67
1006DHB - 1606DHB..... 119		149DC - 2012DC..... 122	1875-210CL..... 29AD18G-75-3048-7 97	BL36S - BL72S..... 151	DDS-24..... 150
1017HBC..... 117		1617HBC..... 117	1875-461..... 35	AD18G-87-1236-5.....	BLH3C - BLH32C..... 122	DG91035..... 67
1035HBC..... 117		1635HBC..... 117	1875-463..... 35AD18G-87-3048-7 97	BP-3639 - BP-4899..... 98	DG91035CL..... 32
1224C - 1272C..... 104		18G-1236-SHELF.....	1875-465..... 35	AD18G-99-1236-5.....	BP-39 - BP-147..... 96	DG91035CO..... 83
1236BK - 1248BK..... 104	18G-3048-SHELF 94	1875-602..... 63AD18G-99-3048-7 97	BSK1824C - BSK2460C..... 124	DG91050..... 67
1236P - 1272P..... 104		18G-39-1236-4.....	1875-604..... 63	AD20G-39-1236-4.....	C	DG91050CL..... 32
1236S - 1272S..... 104	18G-39-3048-6 94	1875-606..... 63AD20G-39-3048-6 96	CAN-34-1436BC-PWB..... 121	DG91050CO..... 83
1239-000..... 51,63		18G-75-1236-5.....	1875-624..... 63	AD20G-75-1236-5.....	CAN-34-1448BC-PWB..... 121	DG92035..... 67
1239-100..... 51	18G-75-3048-7 95	1875-SB803..... 60AD20G-75-3048-7 97	CAN-34-203612BC-PWB..... 121	DG92035CL..... 32
1239-100CL..... 27		18G-87-1236-5.....	1875-SB803CL..... 31	AD20G-87-1236-5.....	CAN-34-2036BC-PWB..... 121	DG92035CO..... 83
1239-101..... 51	18G-87-3048-7 95	1875-SB804..... 60AD20G-87-3048-7 97	CAN-34-204812BC-PWB..... 121	DG92060..... 67
1239-101CL..... 27		18G-99-1236-5.....	1875-SB804CL..... 31	AD20G-99-1236-5.....	CAN-34-2048BC-PWB..... 121	DG92060CL..... 32
1239-102..... 51	18G-99-3048-7 95	1875-SB808..... 60AD20G-99-3048-7 97	CAN-34-36BH-230..... 121	DG92060CO..... 83
1239-102CL..... 27		1824BK - 1872BK..... 104	1875-SB808CL..... 31	ADCL18G-39-1236-4.....	CAN-34-48BH-230..... 121	DG92080..... 67
1239-107..... 51		1824C - 1872C..... 104	1875-SB810..... 60ADCL18G-39-3048-6 100	CAN-34-60BH-230..... 121	DG92080CL..... 32
1239-107CL..... 27		1824S - 1872S..... 104	1875-SB810CL..... 31	ADCL18G-75-1236-5.....	CB14 - CB24..... 120	DG92080CO..... 83
1239-109..... 51		1824SG - 1872SG..... 105	20G-1236-SHELF.....ADCL18G-75-3048-7 101	CC183663 - CC247274..... 140	DG93030..... 67
1239-109CL..... 27		1824SS - 1872SS..... 10520G-3048-SHELF 94	ADCL18G-87-1236-5.....	CC183663CV - CC247274CV... 140	DG93030CL..... 32
1239-201..... 56		1826ESD..... 84,139	20G-39-1236-4.....ADCL18G-87-3048-7 101	CD965 - CD1887..... 66	DG93030CO..... 83
1239-201CL..... 29		1826TR..... 13920G-39-3048-6 94	ADCL18G-99-1236-5.....	CL1239-000..... 63	DG93060..... 67
1239-202..... 56		1830P - 1872P..... 104	20G-75-1236-5.....ADCL18G-99-3048-7 101	CL1239-401..... 63	DG93060CL..... 32
1239-202CL..... 29		183614DE - 246014DE..... 13220G-75-3048-7 95	ADCL20G-39-1236-4.....	CL1239-601..... 63	DG93060CO..... 83
1239-207..... 56		183614PC - 246014PC..... 132	20G-87-1236-5.....ADCL20G-39-3048-6 100	CL1275-000..... 63	DG93080..... 67
1239-207CL..... 29		183634DE - 246034DE..... 13220G-87-3048-7 95	ADCL20G-75-1236-5.....	CL1275-401..... 63	DG93080CL..... 32
1239-209..... 56		183654DE - 246054DE..... 132	20G-99-1236-5.....ADCL20G-75-3048-7 101	CL1275-501..... 63	DG93080CO..... 83
1239-209CL..... 29		18-M-HAMP..... 15420G-99-3048-7 95	ADCL20G-87-1236-5.....	CL1275-601..... 63	DG93120..... 67
1239-401..... 63		18TB - 36TB..... 151	2026ESD..... 84,139ADCL20G-87-3048-7 101	CL1275-701..... 63	DG93120CL..... 32
1239-601..... 63		1836BC6C - 2448BC6C..... 123	2026TR..... 139	ADCL20G-99-1236-5.....	CL1275-801..... 63	DG93120CO..... 83
1239-SB801..... 60		1836DS - 2460DS..... 131	2124C - 2172C..... 104ADCL20G-99-3048-7 101	CL1839-000..... 63	DH8..... 152
1239-SB801CL..... 31		1836FC - 2460FC..... 131	2124S - 2172S..... 104	AD54-1236BK.....	CL1839-602..... 63	DIV12 - DIV36..... 151
1239-SB802..... 60		1836FE - 2460FE..... 131	2124SG - 2172SG..... 105AD54-3672BK-5 106	CL1839-604..... 63	DIV12BK - DIV36BK..... 151
1239-SB802CL..... 31		1836FS - 2460FS..... 131	2124SS - 2172SS..... 105	AD54-1236C - AD54-3672C-5..... 106	CL1839-624..... 63	DIV12S - DIV36S..... 151
1239-SB807..... 60		1836SL - 2448SL..... 131	2136P - 2172P..... 104	AD54-1236P - AD54-3672P-5..... 106	CL1875-000..... 63	DIV18SL - DIV24SL..... 131
1239-SB807CL..... 31		1836SL6C - 2448SL6C..... 134	2436-63SEC - 2460-63SEC... 145	AD54-1236S - AD54-3672S-5..... 106	CL1875-602..... 63	DIV201 - DIV204..... 92
1239-SB809..... 60		1836SM - 2472SM..... 151	2424BK - 2472BK..... 104	AD54-1436SG - AD63-2472SG... 110	CL1875-604..... 63	DIV303 - DIV304..... 86
1239-SB809CL..... 31		1839-000..... 51,63	2424C - 2472C..... 104AD63-2472SG-5 111	CL1875-606..... 63	DIV400..... 87
1275-000..... 51,63		1839-103..... 51	2424S - 2472S..... 104	AD63-1236BK.....	CL1875-624..... 63	DIV401 - DIV801..... 62
1275-100..... 51		1839-103CL..... 27	2424SG - 2472SG..... 105AD63-3672BK-5 107	CL18G-39-1236-4.....	DIV6123..... 62
1275-100CL..... 27		1839-104..... 51	2424SS - 2472SS..... 105	AD63-1236C - AD63-3672C-5..... 107CL18G-39-3048-6 98	DL91035 - DL93120..... 67
1275-101..... 51		1839-104CL..... 27	2430P - 2472P..... 104	AD63-1236P - AD63-3672P-5..... 107	CL18G-75-1236-5.....	DL91035CO - DL93120CO... 83
1275-101CL..... 27		1839-108..... 51	243660EPC - 246060EPC... 145	AD63-1236S - AD63-3672S-5..... 107CL18G-75-3048-7 99	DLT-6..... 30,50,55
1275-102..... 51		1839-108CL..... 27	2439-603..... 63	AD63-1236S - AD63-3672S-5..... 107	CL18G-87-1236-5.....	DLY-2415..... 72-73
1275-102CL..... 27		1839-110..... 51	2475-20-MIX..... 37	AD63-1436SG - AD63-2472SG... 110CL18G-87-3048-7 99	DLY-3018..... 4
1275-107..... 51		1839-110CL..... 27	2475-20-MIXCL..... 24	AD63-1436SG-5.....	CL18G-99-1236-5.....	DMS510C - DMS570C..... 6
1275-107CL..... 27		1839-203..... 56	2475-483..... 35AD63-2472SG-5 111CL18G-99-3048-7 99	DMS531 - DMS543..... 47
1275-109..... 51		1839-203CL..... 29	2475-483485..... 35	AD74-1236BK.....	CL20G-39-1236-4.....	DS18-24..... 150
1275-109CL..... 27		1839-204..... 56	2475-485..... 35AD74-3672BK-5 108CL20G-39-3048-6 98	DS91035 - DS93120..... 67
1275-201..... 56		1839-204CL..... 29	2475-603..... 63	AD74-1236C - AD74-3672C-5..... 108	CL20G-75-1236-5.....	DS91035CO - DS93120CO... 83
1275-201CL..... 29		1839-208..... 56	2475-950..... 37	AD74-1236P - AD74-3672P-5..... 108CL20G-75-3048-7 99	DSB101 - DSB116..... 50
1275-202..... 56		1839-208CL..... 29	2475-950952..... 37	AD74-1236S - AD74-3672S-5..... 108	CL20G-87-1236-5.....	DSB101CO - DSB116CO... 82
1275-202CL..... 29		1839-210..... 56	2475-950952CL..... 24	AD74-1436SG - AD74-2472SG... 110CL20G-87-3048-7 99	DSB201 - DSB216..... 55
1275-207..... 56		1839-210CL..... 29	2475-950CL..... 24AD74-2472SG-5 111	CL20G-99-1236-5.....	DSB801 - DSB816..... 30,59
1275-207CL..... 29		1839-602..... 63	2475-951..... 37AD74-2472SG-5 111CL20G-99-3048-7 99	DSK18 - DSK24..... 124
1275-209..... 56		1839-604..... 63	2475-951CL..... 24	AD86-1236BK.....	CL2439-603..... 63	DSS401 - DSS405..... 34
1275-209CL..... 29		1839-624..... 63	2475-952..... 37AD86-3672BK-5 109	CL2475-603..... 63	DUS200 - DUS270..... 5
1275-401..... 63		1839-SB803..... 60	2475-952CL..... 24	AD86-1236C - AD86-3672C-5..... 109	CL39-1236-4 - CL39-1836-6..... 102	DUS200CO - DUS270CO... 80
1275-423..... 35		1839-SB803CL..... 31	2475-953..... 37	AD86-1236P - AD86-3672P-5..... 109	CL75-1236-4 - CL75-1836-8... 102	DUS950 - DUS955..... 36
1275-425..... 35		1839-SB804..... 60	2475-953954..... 37	AD86-1236S - AD86-3672S-5..... 109	COV210..... 5	DUS970 - DUS976..... 39
1275-441..... 35		1839-SB804CL..... 31	2475-953954CL..... 24	AD86-1436SG - AD86-2472SG... 110	COV220..... 5	DUS993 - DUS997..... 39
1275-443..... 35		1839-SB808..... 60	2475-953CL..... 24AD86-1436SG-5	COV224..... 5	DWB14 - DWB24..... 120
1275-445..... 35		1839-SB808CL..... 31	2475-954..... 37AD86-2472SG-5 111	COV230..... 5	E
1275-501..... 63		1839-SB810..... 60	2475-954CL..... 24	AL-23..... 33	COV235..... 5	EL-12406..... 133
1275-601..... 63		1839-SB810CL..... 31	3036C - 3072C..... 104	AL-35..... 33	COV239..... 5	ELH410 - ELH445..... 50,55,59
1275-701..... 63		1875-000..... 51,63	3036P - 3072P..... 104	AP-39 - AP-75..... 96	COV240..... 5	EP126 - EP228..... 150
1275-801..... 63		1875-103..... 51	3036S - 3072S..... 104	B	COV91000..... 67	EP126S - EP228S..... 150
1275-SB801..... 60		1875-103CL..... 27	362412DPP - 963612DPP... 133	BC212434M1 - BC212469M2... 136	COV91000CL..... 67	ESD-DC..... 152
1275-SB801CL..... 31		1875-104..... 51	362412DPS - 963612DPS... 133BC212434M1CL.....	COV91000CO..... 83	ESD-SS..... 152
1275-SB802..... 60		1875-104CL..... 27	3636C - 3672C..... 104BC212469M2CL 32	COV92000..... 67	F
1275-SB802CL..... 31		1875-108..... 51	3636P - 3672P..... 104	BC212439M4 - BC212439M7... 32,136	COV92000CL..... 67	FG..... 152
1275-SB807..... 60		1875-108CL..... 27	3636S - 3672S..... 104BC212469M11..... 32,136	COV92000CO..... 83	FP..... 152
1275-SB807CL..... 31		1875-110..... 51	3660BK - 3672BK..... 104	BC214069M14D.....	COV93000..... 67	G
1275-SB809..... 60		1875-110CL..... 27	36BH - 60BH..... 131BC214069M22D 137	COV93000CL..... 67	G-725..... 91
1275-SB809CL..... 31		1875-203..... 56	39-1236-4 - 39-1836-6... 102	BC214069M1D.....	COV93000CO..... 83	G-725304-28..... 91
1424C - 1472C..... 104		1875-203CL..... 29	52RT - 84RT..... 142BC214069M2D 137	D	G-725305-36..... 91
1430P - 1472P..... 104		1875-204..... 56	75-1236-4 - 75-1842-8... 102	BC216069M1T - BC216069M2T. 137	DB..... 153	G-725306-56..... 91
1430S - 1472S..... 104		1875-204CL..... 29	A	BC216069M21T.....	DB1836C - DB2460C..... 150	G-725309-80..... 91
1436BC - 204812BC..... 122		1875-208..... 56	AD18G-39-1236-4.....BC216069M33T 137	DB1836S - DB2460S..... 150	G-725569-56..... 91
1436SG - 1472SG..... 105		1875-208CL..... 29AD18G-39-3048-6 96	BL36 - BL72..... 151	DCB14 - DCB24..... 120	GR24 - GR60..... 152

GSP-2448	115	MTT-1860-543	76	PS-WB22143 - PS-WB22148	130	QFS248-76	88	QLP-4819CO	81	QPRD-606	64
GSP-2460	115	MTT-1878-543	76	PS-WBLD-3 - PS-WBLD-8	130	QFS270-72+QFS400	89	QLP-4861 - QLP-4861HC	8	QPRD-701	64
GSP-2472	115	MTT-3042-743	76	PS-WBLS-3 - PS-WBLS-8	130	QFS270-72	88	QLP-4861-220-165	14	QPRD-801	64
GSP-5HOOK-16	115	MTT-3060-743	76	PS-WS2414	130	QFS400	89,93	QLP-4861-220-165CL	23	QPRHA-100	52
GSP-B12128	115	MTT-3078-743	76	PT-NR	153	QGH600	44	QLP-4861-230-80	14	QPRHA-100CL	52
GSP-HOOK6 - GSP-HOOK10	115	MWR4-2419-9	69	PT-NS	153	QGH600CL	25	QLP-4861-230-80CL	23	QPRHA-100CL	52
GSP-SB12128 - GSP-SB2215	115	MWR5-1711-12	69	PT-PR - PT-PR6	153	QGH700	44	QLP-4861-240-35	14	QPRHA-101	52
GSP-WMHD	115	MWR7-1711-8	69	PT-PS - PT-PS6	153	QGH700BR	78	QLP-4861-240-35CL	23	QPRHA-101CL	27
H		MWRS-5-92035	134	PT-PSB - PT-PSB6	153	QGH700CL	25	QLP-4861CO	81	QPRHA-102	52
HANDLE-DLY	4	MWRS-5-92060	134	PWB	120	QGH705MOB	44	QLR500	86,90	QPRHA-102CL	52
HB18C - HB60C	150	MWRS-5-92080	134	Q		QGH705MOBCL	25	QMB510C	6	QPRHA-107	27
HB18S - HB60S	150	MWRS-7-103	134	QB900	79	QGH800	44	QMB520C	6	QPRHA-107CL	27
HBL3C - HBL345C	119	MWRS-7-104	134	QBB-4845-34	74	QGH800CL	25	QMB530C	6	QPRHA-109	52
HD18 - HD36	146	MWRS-7-108	134	QBC111	50,55	QGH805MOB	44	QMB535C	6	QPRHA-109CL	52
HD18-2 - HD36-2	147	MWRS-7-110	134	QBC112	50,55	QGH805MOBCL	25	QMB539C	6	QPRHA-201	57
HD18-3 - HD36-3	147	MWRS-7-602	134	QBR-1819	9	QIC-12123	92	QMB540C	6	QPRHA-201CL	29
HMB510C - HMB570C	6	MWRS-7-604	134	QBR-1819CO	81	QIC-122	92	QMB550C	6	QPRHA-202	57
HNS006	11,13,23	MWRS-7-606	134	QBR-2721	9	QIC-124-122	93	QMB560C	6	QPRHA-202CL	29
HNS200 - HNS230	13	O		QBR-2721-210-24	14	QIC-124-161	93	QMB570C	6	QPRHA-207	57
HNS200CL - HNS230CL	23	OP-39 - OP-147	96	QBR-2721-210-24CL	23	QIC-124-64	93	QMD-36H	12	QPRHA-207CL	29
I		OP-CC	100	QBR-2721-220-24	14	QIC-124-83	93	QMD-36H-220	14	QPRHA-209	57
IDR201 - IDR204	92	ORG80032 - ORG803222	79	QBR-2721-220-24CL	23	QIC-148-122	93	QMD-36H-220CL	23	QPRHA-209CL	29
K		P		QBR-2721-230-12	14	QIC-148-161	93	QMD-36H-230	14	QPRHA-501	64
KEYBD	152	P14BK - P86BK	105	QBR-2721-230-12CL	23	QIC-148-64	93	QMD-36H-230240	14	QPRHA-567	64
L		P6C - P96C	105	QBR-2721CO	81	QIC-148-83	93	QMD-36H-230240CL	23	QPRHA-6	57
LBL2X8 - LBL5X8	67	P6P - P96P	105	QBR-3612	9	QIC-161	92	QMD-36H-230CL	23	QPRHA-601	64
LBL2X8CO - LBL5X8CO	83	P6S - P96S	105	QBR-3612CO	81	QIC-170-122	93	QMD-36H-240	14	QPRHA-701	64
LD965 - LD1887	66	PB-1X1-PH	11	QBR-3619	9	QIC-170-161	93	QMD-36H-240CL	23	QPRS-000	52
LGH700	25,44	PB-1X30-SR - PB-8X30-SR	11	QBR-3619-210-32	14	QIC-170-64	93	QMD-36HCO	81	QPRS-100	52
LH3B - LH69C	150	PB-24X48-2 - PB-24X48-4	10	QBR-3619-210-32CL	23	QIC-170-83	93	QMS531	47	QPRS-100CL	27
LHA3C - LHA24C	150	PB-2-CH - PB-3-CH	11	QBR-3619-220-32	14	QIC-224-122	93	QMS531BR	78	QPRS-101	52
LID1215 - LID2415	72	PB-3-DMU	11	QBR-3619-220-32CL	23	QIC-224-161	93	QMS532	47	QPRS-101CL	27
LID1711 - LID2516-8	70	PB-3X80-DR - PB-8X80-DR	11	QBR-3619-230-18	14	QIC-224-64	93	QMS532BR	78	QPRS-102	52
LID181 - LID301	68	PB-5-DCEL - PB-8-DCEL	11	QBR-3619-230-18CL	23	QIC-224-83	93	QMS533	47	QPRS-102CL	27
LID-4845	74	PB-6X12SHELF	11	QBR-3619CO	81	QIC-248-122	93	QMS533BR	78	QPRS-103	52
LTR-0813	50,55	PB-BINCLIP	11	QCS10	65	QIC-248-161	93	QMS543	47	QPRS-104	52
LTR-1300 - LTR-2400	5	PB-C-QUS200	11	QCS10CO	80	QIC-248-64	93	QMS543BR	78	QPRS-107	52
M		PB-C-QUS200CL	11	QCS-156	65	QIC-248-83	93	QMS743	47	QPRS-107CL	27
M18366DE - M24606DE	132	PB-C-QUS210	11	QCS20	65	QIC-270-122	93	QMS743BR	78	QPRS-108	52
M1836BC6C - M2448BC6C	123	PB-C-QUS210CL	11	QCS20CO	80	QIC-270-161	93	QMS843MOB	47	QPRS-109	52
M1836C46 - M2460C46-5	141	PB-C-QUS220	11	QCS220	65	QIC-270-64	93	QP965 - QP1887	66	QPRS-109CL	27
M1836C46RE		PB-C-QUS220CL	11	QCS30	65	QIC-270-83	93	QPR-101	18	QPRS-110	52
M2460C46RE-5	142	PB-C-QUS230	11	QCS30CO	80	QIC-4163	92	QPR-102	18	QPRS18-000	52
M1836C47 - M2460C47-5	141	PB-C-QUS230CL	11	QCS320	65	QIC-4244	92	QPR-107	18	QPRS18-6	57
M1836C47RE		PB-DRTH	11	QCS35	65	QIC-64	92	QPRD-000	52	QPRS-201	57
M2460C47RE-5	142	PB-HSC-LG - PB-HSC-XL	11	QCS40	65	QIC-8143	92	QPRD-100	52	QPRS-201CL	29
M1836CG46 - M2460CG46-5	141	PB-IC-TSH	11	QCS40CO	80	QIC-8224	92	QPRD-100CL	27	QPRS-202	57
M1836CG46RE		PB-MP-TWH	11	QDC2012-7	73	QIC-83	92	QPRD-101	52	QPRS-202CL	29
M2460CG46RE-5	143	PB-SCH-SC	11	QDC2115-9	73	QLP-1819 - QLP-1819HC	8	QPRD-101CL	27	QPRS-203	57
M1836CG47 - M2460CG47-5	141	PB-SPACER-KT	10	QDC2115-12	73	QLP-1819-210-16	14	QPRD-102	52	QPRS-204	57
M1836CG47RE		PB-SRTH	11	QDC2115-17	73	QLP-1819-210-16CL	23	QPRD-102CL	27	QPRS-207	57
M2460CG47RE-5	143	PC3518-33	77	QDC2213-12	73	QLP-1819-220-16	14	QPRD-103	52	QPRS-207CL	29
M1836SG46 - M2460SG46-5	141	PC3518-33-3	77	QDC2420-12	73	QLP-1819-220-16CL	23	QPRD-104	52	QPRS-208	57
M1836SG47 - M2460SG47-5	141	PC3518SHELF	77	QDC2515-14	73	QLP-1819-230-9	14	QPRD-107	52	QPRS-209	57
M1836SL34C-M2448SL34C	134	PC4026-33	77	QDC2717-12	73	QLP-1819-230-9CL	23	QPRD-107CL	27	QPRS-209CL	29
M1836SL6C - M2448SL6C	134	PC4026-33-3	77	QDC2820-15	73	QLP-1819CO	81	QPRD-108	52	QPRS-210	57
M2036BD - M2048BD	122	PC4026SHELF	77	QDL-2115	73	QLP-1861 - QLP-1861HC	8	QPRD-108	52	QPRS-210CL	57
M2430CLAN	79	PCL1 - PCL2	151	QDS300	89-90	QLP-1861CO	81	QPRD-109CL	27	QPRS-5678	64
M2436-69SEC - M2460-69SEC	145	PCTH	77	QDS-3666H	12	QLP-2721	8	QPRD-110	52	QPRS-6	57
M2436C46E - M2460C46E-5	144	PFTC4026-33-2	77	QDS-3666HCO	81	QLP-2721CO	81	QPRD18-000	52	QPRS-601	64
MD1836C46RE		PFTC4026-33-3	77	QDU-00	27,29,52	QLP-3612	8	QPRD18-6	57	QPRS-602	64
MD2460C46RE-5	142	PH18 - PH36	151	QDU-18	52,57	QLP-3612CO	81	QPRD-201	57	QPRS-604	64
MD1836C47RE		PH18BK - PH24BK	151	QED401	62	QLP-3619 - QLP3619HC	8	QPRD-201CL	29	QPRS-606	64
MD2460C47RE-5	142	PH18S - PH36S	151	QED501	62	QLP-3619-210-32	14	QPRD-202	57	QPRS-701	64
MD1836C46RE		PS-A2475-7S	127	QED601	62	QLP-3619-210-32CL	23	QPRD-202CL	29	QPRS-801	64
MD2460C46RE-5	143	PS-A2475-8PT	127	QED602	62	QLP-3619-220-32	14	QPRD-203	57	QRB166	42
MD1836C47RE		PS-A2475-8WB	127	QED603	62	QLP-3619-220-32CL	23	QPRD-204	57	QRB176MOB	42
MD2460C47RE-5	143	PS-DBC-14PT	129	QED604	62	QLP-3619-230-18	14	QPRD-207	57	QRB206	42
MD2436-70SEC		PS-DBC-14S	129	QED606	62	QLP-3619-230-18CL	23	QPRD-207CL	29	QRB216MOB	42
MD2460-70SEC	145	PS-DBC-14WB	129	QED701	62	QLP-3619CO	81	QPRD-208	57	QRB246	42
MESH-240	18	PS-DBC-7WB7S	129	QED801	62	QLP-3661 - QLP-3661HC	8	QPRD-209	57	QRB256MOB	42
MESH-240250	18	PS-LH3	130	QESTP	146	QLP-3661-220-120	14	QPRD-209CL	29	QRC-4D	21
MESH-250	18	PS-S2475-7S	127	QFS124 - QFS270	89	QLP-3661-220-120CL	23	QPRD-210	57	QRC-7D	21
MSU-16-MIX	48	PS-S2475-8PT	127	QFS124-31	88	QLP-3661-230-60	14	QPRD-501	64	QRU-12D	13
MSU-531	48	PS-S2475-8WB	127	QFS148-38	88	QLP-3661-230-60CL	23	QPRD-5678	64	QRU-12D-220-192	14
MSU-532	48	PS-SBC58-8PT	128	QFS170-36	88	QLP-3661-240-28	14	QPRD-6	57	QRU-12D-220-192CL	23
MSU-533	48	PS-SBC58-6S	128	QFS224-24+QFS400	89	QLP-3661-240-28CL	23	QPRD-601	64	QRU-12D-240-48	14
MSU-543	48	PS-SBC58-8WB	128	QFS224-24	88	QLP-3661CO	81	QPRD-602	64	QRU-12D-240-48CL	23
MTT-1842-543	76	PS-SE - PS-SSE	130	QFS248-76+QFS400	89	QLP-4819	8	QPRD-604	64	QRU-1W	13

QRU-12DCO.....	80	QSB116CO.....	82	QSC-36-MIN.....	18	QUS239CL.....	22	RSO1215-5.....	72	TT-OT9 - TT-OT15.....	75
QRU-12S.....	13	QSB201.....	55	QSC-36S.....	17	QUS239CO.....	80	RSO1215-7.....	72	TTS-18 - TTS-24.....	75
QRU-12S-220-96.....	14	QSB201CL.....	28	QSC-3IS.....	21	QUS240.....	5	RSO1408-7.....	72	TUB1711-8.....	70
QRU-12S-220-96CL.....	23	QSB202.....	55	QSC-48.....	19	QUS240BR.....	78	RSO2415-5.....	72	TUB1711-12.....	70
QRU-12S-240-24.....	14	QSB202CL.....	28	QSC-4803.....	19	QUS240CL.....	22	RSO2415-7.....	72	TUB2417-8.....	70
QRU-12S-240-24CL.....	23	QSB203.....	55	QSC-4804.....	19	QUS240CO.....	80	RSO2415-9.....	72	TUB2417-12.....	70
QRU-12SC0.....	80	QSB203CL.....	28	QSC-4805.....	19	QUS241.....	5	RSO2422-11.....	72	TUB2419-9.....	70
QRU-16D.....	13	QSB204.....	55	QSC-48S.....	19	QUS241BR.....	78	RWR72-1830LD.....	114	TUB2516-8.....	70
QRU-16D-230-96.....	14	QSB204CL.....	28	QSC-4IS-14DS.....	19	QUS241CL.....	22	RWR72-1836LD.....	114	U	
QRU-16D-230-96CL.....	23	QSB205.....	55	QSC-60.....	20	QUS242.....	5	RWR72-1842LD.....	114	UH18 - UH24.....	151
QRU-16DCO.....	80	QSB205CL.....	28	QSC-60-BENCH.....	21	QUS242BR.....	78	RWR72-1848LD.....	114	UH18BK - UH24BK.....	151
QRU-16S.....	13	QSB206.....	55	QSC-60S.....	20	QUS242CL.....	22	RWR72-2430LD.....	114	UH18S - UH24S.....	151
QRU-16S-220230240.....	14	QSB206CL.....	28	QSC-64-2S-6DS.....	17	QUS245.....	5	RWR72-2436LD.....	114	W	
QRU-16S-220230240CL.....	23	QSB207.....	55	QSC-72.....	20	QUS245BR.....	78	RWR72-2442LD.....	114	W7-12-24.....	66
QRU-16S-230-48.....	14	QSB207CL.....	28	QSC-72S.....	20	QUS245CL.....	22	RWR72-2448LD.....	114	W7-12-26.....	66
QRU-16S-230-48CL.....	23	QSB208.....	55	QSC-C240.....	18	QUS250.....	5	S		W7-12-28.....	66
QRU-16SCO.....	80	QSB208CL.....	28	QSC-C240250.....	18	QUS250BR.....	78	SCH1 - SCH1-5.....	150	W7-12-30.....	66
QRU-MOB.....	13,23	QSB209.....	55	QSC-C250.....	18	QUS250CL.....	22	SD36C - SD60C.....	145	W7-14-18.....	66
QRU-MOB0.....	80	QSB209CL.....	28	QSC-CQC122.....	18	QUS250CO.....	80	S-HOOK - S-HOOKSS.....	152	W7-18-24.....	66
QS-000.....	91	QSB210.....	55	QSC-CQC161.....	18	QUS255.....	5	SL12 - SL30.....	151	W7-18-26.....	66
QS-304-28.....	91	QSB210CL.....	28	QSC-CQC64.....	18	QUS255BR.....	78	SL12BK - SL24BK.....	151	W7-18-28.....	66
QS-305306-52.....	91	QSB214.....	55	QSC-CQC83.....	18	QUS255CL.....	22	SL12S - SL30S.....	151	W7-18-30.....	66
QS-305-36.....	91	QSB214CL.....	28	QSMC.....	110-113	QUS255CO.....	80	SLP-A1236 - SLP-A1836.....	9	WGH600 - WGH800.....	25,44
QS-306-56.....	91	QSB216.....	55	QSS-1866H.....	12	QUS260.....	5	SLP-1236 - SLP-1836.....	9	WH-15.....	79
QS-309-80.....	91	QSB216CL.....	28	QSS-1866HCO.....	81	QUS260BR.....	78	snh010.....	68,70	WK.....	146
QS-569-56.....	91	QSB801.....	59	QSS-3666H.....	12	QUS260CL.....	22	snt180.....	68	WLP-1836C.....	7
QS-725.....	91	QSB801CL.....	30	QSS-3666HCO.....	81	QUS260CO.....	80	snt185.....	68	WLP-3036C.....	7
QS-BIG-101.....	91	QSB802.....	59	QTB301.....	86	QUS265.....	5	snt190.....	68	WLP-3048C.....	7
QSB100.....	50	QSB802CL.....	30	QTB302.....	86	QUS265BR.....	78	snt195.....	68	WLP-DMC.....	7
QSB100BR.....	78	QSB803.....	59	QTB303.....	86	QUS265CL.....	22	snt200.....	68	WLP-OSC.....	7
QSB100CL.....	26	QSB803CL.....	30	QTB304.....	86	QUS270.....	5	snt225.....	68	WMS531 - WMS543.....	47
QSB100CO.....	82	QSB804.....	59	QTB305.....	86	QUS270BR.....	78	snt230.....	68	W-PC-STUD.....	105
QSB101.....	50	QSB804CL.....	30	QTB306.....	86	QUS270CL.....	22	snt240.....	68	W-PLB.....	105
QSB101BR.....	78	QSB805.....	59	QTB309.....	86	QUS270CO.....	80	snt300.....	68	W-PLI.....	105
QSB101CL.....	26	QSB805CL.....	30	QTB405.....	87	SP-1239 - SP-3099.....	98	SP-1239 - SP-3099.....	98	WR-00CO.....	153
QSB101CO.....	82	QSB806.....	59	QTB406.....	87	QUS275MOB.....	78	SSB-C3036.....	76	WR-00H.....	153
QSB102.....	50	QSB806CL.....	30	QTB409.....	87	QUS275MOBCL.....	22	SSB-C3036-230240.....	76	WR-00HS.....	153
QSB102BR.....	78	QSB807.....	59	QTB410.....	87	QUS950.....	36	SSB-S3036.....	76	WR10-230240.....	16
QSB102CL.....	26	QSB807CL.....	30	QTB411.....	87	QUS950CL.....	24	SSB-S3036-230240.....	76	WR10-230240CL.....	22
QSB102CO.....	82	QSB808.....	59	QTB412.....	87	QUS951.....	36	SSB423.....	34	WR12-101 - WR12-116.....	53
QSB103.....	50	QSB808CL.....	30	QTB-LP-BKT.....	86,116	QUS951CL.....	24	SSB425.....	34	WR12-101CL - WR12-116CL.....	26
QSB103BR.....	78	QSB809.....	59	QTF24.....	90	QUS952.....	36	SSB441.....	34	WR12-101CO - WR12-116CO.....	82
QSB103CL.....	26	QSB809CL.....	30	QTF320.....	90	QUS952CL.....	24	SSB443.....	34	WR12-93030.....	69
QSB103CO.....	82	QSB810.....	59	QTF320-42.....	90	QUS953.....	36	SSB445.....	34	WR12-93030CL.....	32
QSB104.....	50	QSB810CL.....	30	QTF48.....	90	QUS953CL.....	24	SSB461.....	34	WR-3.....	153
QSB104BR.....	78	QSB814.....	59	QTF70.....	90	QUS954.....	36	SSB463.....	34	WR4-12225.....	69
QSB104CL.....	26	QSB814CL.....	30	QTR24.....	90	QUS954CL.....	24	SSB465.....	34	WR4-39-1236-801.....	61
QSB104CO.....	82	QSB816.....	59	QTR48.....	90	QUS955.....	36	SSB483.....	34	WR4-39-1236-801CL.....	31
QSB105.....	50	QSB816CL.....	30	QTR70.....	90	QUS955CL.....	24	SSB485.....	34	WR4-39-1236-802.....	61
QSB105BR.....	78	QSBU-230240.....	15	QUS200.....	5	QUS964MOB.....	36	SST-2436U - SST-2472U.....	155	WR4-39-1236-802CL.....	31
QSB105CL.....	26	QSBU-230240CL.....	22	QUS200BR.....	78	QUS964MOBCL.....	24	SST-MOB.....	155	WR4-39-1236-807.....	61
QSB105CO.....	82	QSBU-239.....	15	QUS200CL.....	22	QUS965MOB.....	36	T		WR4-39-1236-807CL.....	31
QSB106.....	50	QSBU-239CL.....	22	QUS210.....	5	QUS965MOBCL.....	24	TBC-32WT.....	87	WR4-39-1236-809.....	61
QSB106BR.....	78	QSBU-240.....	15	QUS210BR.....	78	QUS970.....	39	TC-19 - TC-39.....	139	WR4-39-1236-809CL.....	31
QSB106CL.....	26	QSBU-240CL.....	22	QUS210CL.....	22	QUS973.....	39	TC-19CO - TC-39CO.....	84	WR5-270.....	16
QSB106CO.....	82	QSBU-245CL.....	22	QUS210CO.....	80	QUS974.....	39	TC-500.....	77	WR5-270CL.....	22
QSB107.....	50	QSBU-250.....	15	QUS220.....	5	QUS975.....	39	TC-EL38.....	139	WR5-36MSBA.....	122
QSB107BR.....	78	QSBU-250CL.....	22	QUS220BR.....	78	QUS976.....	39	TC-EL38CO.....	84	WR5-36MSBA-MOB.....	122
QSB107CL.....	26	QSBU-255.....	15	QUS220CL.....	22	QUS984MOB.....	39	TK-2 - TK-7.....	148	WR5-39-1236-201.....	58
QSB107CO.....	82	QSBU-255CL.....	22	QUS220CO.....	80	QUS985MOB.....	39	TK-CA.....	148	WR5-39-1236-201CL.....	28
QSB108.....	50	QSBU-260.....	15	QUS221.....	5	QUS986MOB.....	39	TK-CBW.....	148	WR5-39-1236-202.....	58
QSB108BR.....	78	QSBU-260CL.....	22	QUS221BR.....	78	QUS993.....	39	TK-DTB18 - TK-DTB24.....	148	WR5-39-1236-202CL.....	28
QSB108CL.....	26	QSBU-265.....	15	QUS221CL.....	22	QUS994MOB.....	39	TK-EP.....	148	WR5-39-1236-207.....	58
QSB108CO.....	82	QSBU-265CL.....	22	QUS224.....	5	QUS995.....	39	TK-STB18 - TK-STB24.....	148	WR5-39-1236-207CL.....	28
QSB109.....	50	QSBU-270.....	15	QUS224BR.....	78	QUS996MOB.....	39	TR1-2516-8.....	71	WR5-39-1236-209.....	58
QSB109BR.....	78	QSBU-270CL.....	22	QUS224CL.....	22	QUS997.....	39	TR2-2516-8.....	71	WR5-39-1236-209CL.....	28
QSB109CL.....	26	QSBU-600.....	45	QUS230.....	5	QUS998MOB.....	39	TR3-2516-8.....	71	WR54-1236BK.....	
QSB109CO.....	82	QSBU-600800.....	45	QUS230BR.....	78	QVTRK.....	146	TR4-2516-8.....	71WR54-3672BK-5	106
QSB110.....	50	QSBU-600800CL.....	25	QUS230CL.....	22	QVTRK-2-72EST.....		TR5-2516-8.....	71WR54-1236C	
QSB110BR.....	78	QSBU-600CL.....	25	QUS230CO.....	80QVTRK-2-240EST	147	TR6-2516-8.....	71WR54-3672C-5	106
QSB110CL.....	26	QSBU-700.....	45	QUS234.....	5	QVTRK-3-72EST.....		TR9.....	79WR54-1236P	
QSB110CO.....	82	QSBU-700CL.....	25	QUS234BR.....	78QVTRK-3-240EST	147	TS18C - TS24C.....	139WR54-3672P-5	106
QSB114.....	50	QSBU-800.....	45	QUS234CL.....	22	R		TS32C - TS62C.....	139	WR54-1236S.....	
QSB114BR.....	78	QSBU-800CL.....	25	QUS235.....	5	RC1215-089.....	72	TT-CT9 - TT-CT15.....	75WR54-3672S-5	106
QSB114CL.....	26	QSC-36.....	17	QUS235BR.....	78	RC2415-075.....	72	TTD-30 - TTD-40.....	75	WR54-1436SG.....	
QSB114CO.....	82	QSC-36-4IS-12DS.....	17	QUS235CL.....	22	RC2415-089.....	72	TTK-8 - TTK-21.....	149WR54-2472SG	110
QSB116.....	50	QSC-3672-4D.....	18	QUS235CO.....	80	RC2415-111.....	72	TTK-C18 - TTK-C24.....	149	WR54-1436SG-5.....	
QSB116BR.....	78	QSC-36-96-4IS.....	17	QUS239.....	5	RC2415-147.....	72	TTK-E18 - TTK-E24.....	149WR54-2472SG-5	111
QSB116CL.....	26	QSC-36-FD.....	17	QUS239BR.....	78	RSO1207-5.....	72	TTK-M18 - TTK-M24.....	149	WR5-533.....	49

WR5-543.....49	WR74-1248-66102.....54	WR86-1236S.....	WR9-216CL.....28	WRC74-BSK1824C-5.....WRSC-1848-2SS 138
WR5-600 - WR5-800.....46	WR74-1260-101102.....54WR86-3672S-5 109	WR9-36180.....69WRC74-BSK2460C-5 124	WRSC-1836-3 - WRSC-1848-3... 138
WR5-600CL - WR5-800CL.....25	WR74-1260-143101.....54	WR86-1436SG.....	WR9-531.....49	WRC9-63-2448-105.....156	WRSC-1836SS-3S.....
WR5-955.....38	WR74-1260-88102.....54WR86-2472SG 110	WR9-92060.....69	WRC-BC2448.....156WRSC-1848SS-3S 138
WR5-955CL.....24	WR74-1272-101102.....54	WR86-1436SG-5.....	WR9-92060CL.....32	WRCGR-63-2436.....	WRSC-1836-3SS.....
WR5-975.....40	WR74-1272-110102.....54WR86-2472SG-5 111	WR9-93060.....69WRCGR-63-2460 157WRSC-1848-3SS 138
WR5-993.....41	WR74-1272-176101.....54	WR8-801.....61	WR9-93060CL.....32	WR-CH.....156	WRSC-2436-2 - WRSC-2448-2... 138
WR5-995.....41	WR74-1436SG.....	WR8-801CL.....31	WRA86-2136C-166.....43	WRC-IT-1824.....138	WRSC-2436SS-2S.....
WR5-997.....41WR74-2472SG 110	WR8-802.....61	WRA86-2142C-206.....43	WRC-LPSW1863.....154WRSC-2448SS-2S 138
WR6-13-MIX.....49	WR74-1436SG-5.....	WR8-802CL.....31	WRA86-2148C-246.....43	WRCPL-63-2460.....157	WRSC-2436-2SS.....
WR6-24185.....69WR74-2472SG-5 111	WR8-803.....61	WRA86-2154C-166.....43	WRCPL-63-2460-955.....158WRSC-2448-2SS 138
WR6-260.....16	WR74-1848-103104.....54	WR8-803CL.....31	WRA86-2172C-246.....43	WRCS4-63-2436EP.....	WRSC-2436-3 - WRSC-2448-3... 138
WR6-260CL.....22	WR74-1848-110103.....54	WR8-804.....61	WRC-1836-2 - WRC-1848-2.....138WRCS4-63-2460EP-5 144	WRSC-2436SS-3S.....
WR6-265.....16	WR74-1848-66104.....54	WR8-804CL.....31	WRC-1836BK-2.....	WRCSC4-74-2436EP.....WRSC-2448SS-3S 138
WR6-265CL.....22	WR74-1860-103104.....54	WR8-805.....61WRC-1848BK-2 138WRCS4-74-2460EP-5 144	WRSC-2436-3SS.....
WR63-1236BK.....	WR74-1860-143103.....54	WR8-805CL.....31	WRC-1836-2CG.....	WRCSL5-63-1836.....WRSC-2448-3SS 138
.....WR63-3672BK-5 107	WR74-1860-88104.....54	WR8-806.....61WRC-1848-2CG 138WRCSL5-63-2448 135	WRSC3-42-2436FS.....
WR63-1236C.....	WR74-1872-103104.....54	WR8-806CL.....31	WRC-1836-2CO.....	WRCSL5-63-1836-104.....WRSC3-42-2460FS 155
.....WR63-3672C-5 107	WR74-1872-110104.....54	WR8-807.....61WRC-1848-2CO 84WRCSL5-63-2448-106 135	WRSC4-54-2436FS.....
WR63-1236P.....	WR74-1872-176103.....54	WR8-807CL.....31	WRC-1836-2G.....	WRCSL5-63-1836EP.....WRSC4-54-2460FS 155
.....WR63-3672P-5 107	WR74-2448-105106.....54	WR8-808.....61WRC-1848-2G 138WRCSL5-63-2448EP 135	WRSL6-74-1848-260.....134
WR63-1236S.....	WR74-2448-110105.....54	WR8-808CL.....31	WRC-1836-3 - WRC-1848-3.....138	WRCSL5-63-1836EP-104.....	WRSL6-74-2448-953.....134
.....WR63-3672S-5 107	WR74-2448-66106.....54	WR8-809.....61	WRC-1836BK-3.....WRCSL5-63-2448EP-106 135	WR-SP.....152
WR63-1436SG.....	WR74-2460-105106.....54	WR8-809CL.....31WRC-1848BK-3 138	WRCSL5-74-1836-104220.....	WR-SS - WR-SSCO.....152
.....WR63-2472SG 110	WR74-2460-143105.....54	WR8-810.....61	WRC-1836-3CG.....WRCSL5-74-1848-104220 135	WR-WMB.....152
WR63-1436SG-5.....	WR74-2460-88106.....54	WR8-810CL.....31WRC-1848-3CG 138	WRCSL6-74-1848-260.....134	WS-1218DSHC.....
.....WR63-2472SG-5 111	WR74-2472-105106.....54	WR8-814.....61	WRC-1836-3CO.....	WRCSL6-74-2448-953.....134WS-1848DSHC 119
WR6-36-1236-101.....53	WR74-2472-110106.....54	WR8-814CL.....31WRC-1848-3CO 84	WRC-SW2448.....154	WS70-DS18ADHC.....
WR6-36-1236-101CL.....26	WR74-2472-176105.....54	WR8-816.....61	WRC-1836-3G.....	WR-D24W.....137WS70-DS48ADHC 117
WR6-36-1236-101CO.....82	WR7-532.....49	WR8-816CL.....31WRC-1848-3G 138	WRDBS4-63-2436EP.....	WS70-DS18HC.....
WR6-36-1236-102.....53	WR7-92080.....69	WR8-950.....38	WRC2-1836-1265.....66WRDBS4-63-2460EP-5 144WS70-DS48HC 117
WR6-36-1236-102CL.....26	WR7-92080CL.....32	WR8-950952.....38	WRC2-1836-1285.....66	WRDBS4-74-2436EP.....	WS70-SS18-4S3L.....
WR6-36-1236-102CO.....82	WR7-951.....38	WR8-950952CL.....24	WRC2-1836-1867.....66WRDBS4-74-2460EP-5 144WS70-SS18AD-7S 118
WR6-36-1236-107.....53	WR7-951CL.....24	WR8-950CL.....24	WRC2-1836-1887.....66	WRGR-63-2436.....	WS70-SS18ADHC.....
WR6-36-1236-107CL.....26	WR8-239.....16	WR8-952.....38	WRC2-36-3036-976.....158WRGR-63-2460 157WS70-SS48ADHC 117
WR6-36-1236-107CO.....82	WR8-239CL.....22	WR8-952CL.....24	WRC-2436-2 - WRC-2448-2.....138	WR-PS.....153	WS70-SS18HC.....
WR6-36-1236-109.....53	WR8-240.....16	WR8-970.....40	WRC-2436BK-2.....	WR-RG.....153WS70-SS48HC 117
WR6-36-1236-109CL.....26	WR8-240CL.....22	WR9-201.....58WRC-2448BK-2 138	WRS4-54-1436SS.....	WS70-SS36-4S3L.....
WR6-36-1236-109CO.....82	WR8-245CL.....22	WR9-201CL.....28	WRC-2436-2CG.....WRS4-86-2472SS 112WS70-SS36AD-7S 118
WR6-953.....38	WR8-250.....16	WR9-202.....58WRC-2448-2CG 138	WRS5-54-1436SS.....	WS-DR10C.....9,119
WR6-953954CL.....24	WR8-250CL.....22	WR9-202CL.....28	WRC-2436-2CO.....WRS5-86-2472SS 113	WS-DSMOB.....116
WR6-953CL.....24	WR8-255.....16	WR9-203.....58WRC-2448-2CO 84	WRS-5-92035.....134	WS-HB36HC.....119
WR6-954.....38	WR8-255CL.....22	WR9-203CL.....28	WRC-2436-2G.....	WRS-5-92060.....134	WS-HB48HC.....119
WR6-954CL.....24	WR8-423.....35	WR9-204.....58WRC-2448-2G 138	WRS-5-92080.....134	WS-HBB.....119
WR6-973.....40	WR8-425.....35	WR9-204CL.....28	WRC-2436-3 - WRC-2448-3.....138	WRS-7-103.....134	WS-HBBA.....119
WR6-973974.....40	WR8-441.....35	WR9-205.....58	WRC-2436BK-3.....	WRS-7-104.....134	WS-HBBA-D.....119
WR6-974.....40	WR8-443.....35	WR9-205CL.....28WRC-2448BK-3 138	WRS-7-108.....134	WS-HBB-D.....119
WR7-20-MIX.....38	WR8-445.....35	WR9-206.....58	WRC-2436-3CG.....	WRS-7-110.....134	WS-HDS12.....9,119
WR7-20-MIXCL.....24	WR8-461.....35	WR9-206CL.....28WRC-2448-3CG 138	WRS-7-602.....134	WS-HDS6.....9,119
WR7-245CL.....22	WR8-463.....35	WR9-207.....58	WRC-2436-3CO.....	WRS-7-604.....134	WS-HTH.....9,119
WR74-1236BK.....	WR8-465.....35	WR9-207CL.....28WRC-2448-3CO 84	WRS-7-606.....134	WS-MOB.....116
.....WR74-3672BK-5 108	WR8-483.....35	WR9-208.....58	WRC-2436-3G.....	WRSAD4-54-1436SS.....	WS-PM18HC.....117
WR74-1236C.....	WR8-483485.....35	WR9-208CL.....28WRC-2448-3G 138WRSAD4-86-2472SS 112	WS-PM36HC.....117
.....WR74-3672C-5 108	WR8-485.....35	WR9-209.....58	WRC2-63-3036-974976.....158	WRSAD5-54-1436SS.....	WS-PM48HC.....117
WR74-1236P.....	WR86-1236BK.....	WR9-209CL.....28	WRC3-1836-1265.....66WRSAD5-86-2472SS 113	WS-SR9C.....9,119
.....WR74-3672P-5 108WR86-3672BK-5 109	WR9-210.....58	WRC3-1836-1285.....66	WR-SB2R2.....153	WS-SSMOB.....116
WR74-1236S.....	WR86-1236C.....	WR9-210CL.....28	WRC3-1836-1867.....66	WRSC-1836-2 - WRSC-1848-2... 138	WS-VTH.....9,119
.....WR74-3672S-5 108WR86-3672C-5 109	WR9-214.....58	WRC3-1836-1887.....66	WRSC-1836SS-2S.....	WUS221 - WUS270.....5
WR74-1248-101102.....54	WR86-1236P.....	WR9-214CL.....28	WRCS5-63-2436-92060.....WRSC-1848SS-2S 138	WUS950 - WUS955.....36
WR74-1248-110101.....54WR86-3672P-5 109	WR9-216.....58WRC5-63-2460-92060 136	WRC-1836-2SS.....	WUS970 - WUS976.....39

COLOR OPTION ORDERING INSTRUCTIONS

In order to properly process your order, please include a color code suffix to any model number available with color options. Use the two letter abbreviation listed below and add them to the end of the model number without any spaces or dashes. (i.e. **QSB101** in Blue would be submitted as **QSB101BL**)

- **BK** BLACK
- **BL** BLUE
- **BR** RECYCLED
- **CL** CLEAR
- **CO** CONDUCTIVE

- **GN** GREEN
- **GY** GRAY
- **IV** IVORY
- **OR** ORANGE
- **PK** PINK

- **RD** RED
- **WT** WHITE
- **YL** YELLOW

VISIT US ONLINE
to view our full product line

Our mission is to be your one stop source for bins, bin systems, totes and containers, both consumer and industrial, and wire and wire shelving systems. Contact Quantum Storage Systems today and revolutionize the way you organize.



CORPORATE OFFICE

15800 NW 15th Avenue
Miami, Florida 33169

Toll Free

1-800-685-4665

Phone

(305) 687-0405

Fax

(305) 688-2790



MIDWEST DISTRIBUTION CENTER

2600 United Lane
Elk Grove Village, IL 60007

CANADIAN OPERATIONS

1624 Concession Road
Cambridge, Ontario N3H 4L9

Toll Free

1-866-981-3333

Phone

(519) 653-8848

Fax

(519) 653-7989



sales@quantumstorage.com
www.quantumstorage.com

ACCEPTING



CATALOG NO. 080114

Distributed by:

CLASS C COMPONENTS
4655 BOWWOOD DRIVE N.W. RAINIER, MN 55345
TEL: 763-444-1000 FAX: 763-444-1001
ISO 9001 Certified Company
www.classcomponents.com
Quality • Service • Versatility